

# TOSHIBA

## Industrial Inverter (For 3-phase induction motors)

---

### Instruction Manual

---

# TOSVERT™ VF-FS1

3-phase 200V class	0.4 to 30kW
3-phase 400V class	0.4 to 75kW

#### NOTICE

1. Make sure that this instruction manual is delivered to the end user of the inverter unit.
2. Read this manual before installing or operating the inverter unit, and store it in a safe place for reference.



E6581381②

Safety precautions	<b>I</b>
Introduction	<b>II</b>
Contents	
Read first	<b>1</b>
Connection	<b>2</b>
Operations	<b>3</b>
Basic VF-FS1 operations	<b>4</b>
Basic parameters	<b>5</b>
Extended parameters	<b>6</b>
Applied operation	<b>7</b>
Monitoring the operation status	<b>8</b>
Measures to satisfy the standards	<b>9</b>
Peripheral devices	<b>10</b>
Table of parameters and data	<b>11</b>
Specifications	<b>12</b>
Before making a service call	<b>13</b>
Inspection and maintenance	<b>14</b>
Warranty	<b>15</b>
Disposal of the inverter	<b>16</b>

# I. Safety precautions

The items described in these instructions and on the inverter itself are very important so that you can use the inverter safely, prevent injury to yourself and other people around you as well as to prevent damage to property in the area. Thoroughly familiarize yourself with the symbols and indications shown below and then continue to read the manual. Make sure that you observe all warnings given.



## Explanation of markings

Marking	Meaning of marking
 <b>Warning</b>	Indicates that errors in operation may lead to death or serious injury.
 <b>Caution</b>	Indicates that errors in operation may lead to injury (*1) to people or that these errors may cause damage to physical property. (*2)

(\*1) Such things as injury, burns or shock that will not require hospitalization or long periods of outpatient treatment.

(\*2) Physical property damage refers to wide-ranging damage to assets and materials.

## Meanings of symbols

Marking	Meaning of marking
	Indicates prohibition (Don't do it). What is prohibited will be described in or near the symbol in either text or picture form.
	Indicates something mandatory (must be done). What is mandatory will be described in or near the symbol in either text or picture form.
	Indicates danger or warning. What is dangerous, or what the wiring should be applied be applied to will be described in or near the symbol in either text or picture form.

## ■ Limits in purpose







This inverter is used for controlling speeds of three-phase induction motors in general industrial use.





### Safety precautions



- ▼ The inverter cannot be used in any device that would present danger to the human body or from which malfunction or error in operation would present a direct threat to human life (nuclear power control device, aviation and space flight control device, traffic device, life support or operation system, safety device, etc.). If the inverter is to be used for any special purpose, first get in touch with the supplier.
- ▼ This product was manufactured under the strictest quality controls but if it is to be used in critical equipment, for example, equipment in which errors in malfunctioning signal output system would cause a major accident, safety devices must be installed on the equipment.
- ▼ Do not use the inverter for loads other than those of properly applied three-phase induction motors in general industrial use. (Use in other than properly applied three-phase induction motors may cause an accident.)

## ■ General Operation



 <b>Warning</b>		See item
 Disassembly prohibited	<ul style="list-style-type: none"> <li>Never disassemble, modify or repair. This can result in electric shock, fire and injury. For repairs, call your sales distributor.</li> </ul>	2.
 Prohibited	<ul style="list-style-type: none"> <li>Never remove the front cover when power is on or open door if enclosed in a cabinet. The unit contains many high voltage parts and contact with them will result in electric shock.</li> <li>Don't stick your fingers into openings such as cable wiring hole and cooling fan covers. This can result in electric shock or other injury.</li> <li>Don't place or insert any kind of object into the inverter (electrical wire cuttings, rods, wires etc.). This can result in electric shock or fire.</li> <li>Do not allow water or any other fluid to come in contact with the inverter. This can result in electric shock or fire.</li> </ul>	2.1 2. 2. 2.
 Mandatory	<ul style="list-style-type: none"> <li>Turn power on only after attaching the front cover or closing door if enclosed in a cabinet. If power is turned on without the front cover attached or closing door if enclosed in a cabinet, this can result in electric shock or other injury.</li> <li>If the inverter begins to emit smoke or an unusual odor, or unusual sounds, immediately turn power off. If the equipment is continued in operation in such a state, the result may be fire. Call your local sales agency for repairs.</li> <li>Always turn power off if the inverter is not used for long periods of time since there is a possibility of malfunction caused by leaks, dust and other material. If power is left on with the inverter in that state, it may result in fire.</li> </ul>	2.1 3. 3.
 <b>Caution</b>		See item
 Prohibited contact	<ul style="list-style-type: none"> <li>Do not touch heat radiating fins or discharge resistors. These device are hot, and you'll get burned if you touch them.</li> </ul>	3.

## ■ Transportation & installation



 Warning		See item
 Prohibited	<ul style="list-style-type: none"> <li>Do not install or operate the inverter if it is damaged or any component is missing. This can result in electric shock or fire. Please consult your local sales agency for repairs. Call your local sales agency for repairs.</li> </ul>	1.4.4
	<ul style="list-style-type: none"> <li>Do not place any inflammable objects nearby. If a flame is emitted due to malfunction, it may result in a fire.</li> </ul>	1.4.4
	<ul style="list-style-type: none"> <li>Do not install in any location where the inverter could come into contact with water or other fluids.</li> </ul> <p>This can result in electric shock or fire.</p>	2.
 Mandatory	<ul style="list-style-type: none"> <li>Must be used in the environmental conditions prescribed in the instruction manual. Use under any other conditions may result in malfunction.</li> </ul>	1.4.4
	<ul style="list-style-type: none"> <li>Mount the inverter on a metal plate. The rear panel gets very hot. Do not install in an inflammable object, this can result in fire.</li> </ul>	1.4.4
	<ul style="list-style-type: none"> <li>Do not operate with the front panel cover removed. This can result in electric shock. Failure to do so can lead to risk of electric shock and can result in death or serious injury.</li> </ul>	1.4.4
	<ul style="list-style-type: none"> <li>An emergency stop device must be installed that fits with system specifications (e.g. shut off input power then engage mechanical brake). Operation cannot be stopped immediately by the inverter alone, thus risking an accident or injury.</li> <li>All options used must be those specified by Toshiba. The use of any other option may result in an accident.</li> </ul>	1.4.4



 Caution		See item
 Prohibited	<ul style="list-style-type: none"> <li>When transporting or carrying, do not hold by the front panel covers. The covers may come off and the unit will drop out resulting in injury.</li> </ul>	2.
	<ul style="list-style-type: none"> <li>Do not install in any area where the unit would be subject to large amounts of vibration. That could result in the unit falling, resulting in injury.</li> </ul>	1.4.4
 Mandatory	<ul style="list-style-type: none"> <li>The main unit must be installed on a base that can bear the unit's weight. If the unit is installed on a base that cannot withstand that weight, the unit may fall resulting in injury.</li> </ul>	1.4.4
	<ul style="list-style-type: none"> <li>If braking is necessary (to hold motor shaft), install a mechanical brake. The brake on the inverter will not function as a mechanical hold, and if used for that purpose, injury may result.</li> </ul>	1.4.4

## ■ Wiring



 Warning		See item
 Prohibited	<ul style="list-style-type: none"> <li>Do not connect input power to the output (motor side) terminals (U/T1,V/T2,W/T3). That will destroy the inverter and may result in fire.</li> </ul>	2.2
	<ul style="list-style-type: none"> <li>Do not connect resistors to the DC terminals (between PA/+ and PC/-). That may cause a fire.</li> </ul>	2.2
	<ul style="list-style-type: none"> <li>Within ten minutes after turning off input power, do not touch wires of devices (MCCB) connected to the input side of the inverter. That could result in electric shock.</li> </ul>	2.2



I

 Warning		See item
 Mandatory	<ul style="list-style-type: none"> <li>Electrical installation work must be done by a qualified expert. Connection of input power by someone who does not have that expert knowledge may result in fire or electric shock.</li> </ul>	2.1
	<ul style="list-style-type: none"> <li>Connect output terminals (motor side) correctly. If the phase sequence is incorrect, the motor will operate in reverse and that may result in injury.</li> </ul>	2.1
	<ul style="list-style-type: none"> <li>Wiring must be done after installation. If wiring is done prior to installation that may result in injury or electric shock</li> </ul>	2.1
	<ul style="list-style-type: none"> <li>The following steps must be performed before wiring.               <ol style="list-style-type: none"> <li>Turn off all input power.</li> <li>Wait at least ten minutes and check to make sure that the charge lamp is no longer lit.</li> <li>Use a tester that can measure DC voltage (800VDC or more), and check to make sure that the voltage to the DC main circuits (across PA/+ and PC/-) is 45V or less.</li> </ol>               If these steps are not properly performed, the wiring will cause electric shock.             </li> </ul>	2.1
	<ul style="list-style-type: none"> <li>Tighten the screws on the terminal board to specified torque. If the screws are not tightened to the specified torque, it may lead to fire.</li> <li>Check to make sure that the input power voltage is +10%, -15% of the rated power voltage written on the rating label (<math>\pm 10\%</math> when the load is 100% in continuous operation). If the input power voltage is not +10%, -15% of the rated power voltage (<math>\pm 10\%</math> when the load is 100% in continuous operation) this may result in fire.</li> </ul>	2.1 1.4.4
 Be Grounded	<ul style="list-style-type: none"> <li>Ground must be connected securely. If the ground is not securely connected, it could lead to electric shock or fire when a malfunction or current leak occurs.</li> </ul>	2.1 2.2



 Caution		See item
 Prohibited	<ul style="list-style-type: none"> <li>Do not attach equipment (such as noise filters or surge absorbers) that have built-in capacitors to the output (motor side) terminals. That could result in a fire.</li> </ul>	2.1

## ■ Operations



 Warning		See item
 Prohibited	<ul style="list-style-type: none"> <li>Do not touch inverter terminals when electrical power is going to the inverter even if the motor is stopped. Touching the inverter terminals while power is connected to it may result in electric shock.</li> <li>Do not touch switches when the hands are wet and do not try to clean the inverter with a damp cloth. Such practices may result in electric shock.</li> <li>Do not go near the motor in alarm-stop status when the retry function is selected. The motor may suddenly restart and that could result in injury. Take measures for safety, e.g. attaching a cover to the motor, against accidents when the motor unexpectedly restarts.</li> </ul>	3. 3. 3.
 Mandatory	<ul style="list-style-type: none"> <li>Turn input power on after attaching the front cover. When installed inside a cabinet and using with the front cover removed, always close the cabinet doors first and then turn power on. If the power is turned on with the front cover or the cabinet doors open, it may result in electric shock.</li> <li>Make sure that operation signals are off before resetting the inverter after malfunction. If the inverter is reset before turning off the operating signal, the motor may restart suddenly causing injury.</li> </ul>	3. 3.

 <b>Caution</b>		See item
 Prohibited	<ul style="list-style-type: none"> <li>Observe all permissible operating ranges of motors and mechanical equipment. (Refer to the motor's instruction manual.) Not observing these ranges may result in injury.</li> </ul>	3.



When sequence for restart after a momentary failure is selected (inverter)

 <b>Caution</b>		See item
 Mandatory	<ul style="list-style-type: none"> <li>Stand clear of motors and mechanical equipment. If the motor stops due to a momentary power failure, the equipment will start suddenly after power recovers. This could result in unexpected injury.</li> <li>Attach warnings about sudden restart after a momentary power failure on inverters, motors and equipment for prevention of accidents in advance.</li> </ul>	6.12.1  6.12.1



When retry function is selected (inverter)

 <b>Caution</b>		See item
 Mandatory	<ul style="list-style-type: none"> <li>Stand clear of motors and equipment. If the motor and equipment stop when the alarm is given, selection of the retry function will restart them suddenly after the specified time has elapsed. This could result in unexpected injury.</li> <li>Attach warnings about sudden restart in retry function on inverters, motors and equipment for prevention of accidents in advance.</li> </ul>	6.12.3  6.12.3

Maintenance and inspection

 <b>Warning</b>		See item
 Prohibited	<ul style="list-style-type: none"> <li>Do not replace parts. This could be a cause of electric shock, fire and bodily injury. To replace parts, call the local sales agency.</li> </ul>	14.2
 Mandatory	<ul style="list-style-type: none"> <li>The equipment must be inspected every day. If the equipment is not inspected and maintained, errors and malfunctions may not be discovered and that could result in accidents.</li> <li>Before inspection, perform the following steps.                             <ol style="list-style-type: none"> <li>Turn off all input power to the inverter.</li> <li>Wait at least ten minutes and check to make sure that the charge lamp is no longer lit.</li> <li>Use a tester that can measure DC voltages (800VDC or more), and check to make sure that the voltage to the DC main circuits (across PA+ and PC/-) is 45V or less.</li> </ol>                             If inspection is performed without performing these steps first, it could lead to electric shock.                         </li> </ul>	14.  14.

## Disposal

 Caution		See item
 Mandatory	<ul style="list-style-type: none"> <li>If you throw away the inverter, have it done by a specialist in industry waste disposal(*). If you throw away the inverter by yourself, this can result in explosion of capacitor or produce noxious gases, resulting in injury.</li> <li>(* ) Persons who specialize in the processing of waste and known as "industrial waste product collectors and transporters" or "industrial waste disposal persons." If the collection, transport and disposal of industrial waste is done by someone who is not licensed for that job, it is a punishable violation of the law. (Laws in regard to cleaning and processing of waste materials)</li> </ul>	16.

## Attach warning labels

Shown here are examples of warning labels to prevent, in advance, accidents in relation to inverters, motors and other equipment.

Be sure to affix the caution label where it is easily visible when selecting the auto-restart function (⇒ See section 6.12.1) or the retry function (⇒ See section 6.12.3).

If the inverter has been programmed for restart sequence of momentary power failure, place warning labels in a place where they can be easily seen and read.  
(Example of warning label)

	<b>Warning (Functions programmed for restart)</b>
Do not go near motors and equipment. Motors and equipment that have stopped temporarily after momentary power failure will restart suddenly after recovery.	

If the retry function has been selected, place warning labels in a location where they can be easily seen and read.  
(Example of warning label)

	<b>Warning (Functions programmed for retry)</b>
Do not go near motors and equipment. Motors and equipment that have stopped temporarily after an alarm will restart suddenly after the specified time has elapsed.	

## II. Introduction

---

---

II

Thank you for your purchase of the Toshiba "TOSVERT VF-FS1" industrial inverter.

This is the Ver.118 / Ver.119 CPU version inverter.  
Please be informed that CPU version will be frequently upgraded.

### ■ Features

#### 1. Built-in noise filter

- 1) All models in both the 200V and 400V series have a noise filter inside.
- 2) Can be compliant with European CE marking standard
- 3) Reduces space requirements and cuts down on time and labor needed in wiring.

#### 2. Simple operation

- 1) Automatic functions (history, wizard, acceleration/deceleration time, and function programming)  
Just by wiring the motor to the power supply allows instant operation without the need to program parameters.
- 2) The RUN/STOP button and LOC/REM button allow easy operation.

#### 3. Superior basic performance

- 1) Automatic energy-saving
- 2) Smooth operation : Reduced rotation ripple through the use of Toshiba's unique waveform formation.
- 3) Built-in current surge suppression circuit : Can be safely connected even if power load is low.
- 4) Maximum 200Hz high frequency output : Optimum for use with high speed motors such as those in lumber machinery and milling machines.
- 5) Maximum carrier frequency : 16kHz quiet operation  
Toshiba's unique PWM control reduces noise at low carrier.

#### 4. Globally compatible

- 1) Compatible with 200V and 400V power supplies
- 2) Conforms to CE marking and with UL, CSA.
- 3) Sink/source switching of control input.

#### 5. Options allow use with a wide variety of applications

- Internal communications devices (LonWorks<sup>®</sup>, BACnet<sup>®</sup>, Metasys<sup>®</sup> N2, Siemens APOGEE<sup>™</sup> FLN.)
- Extension panel/Parameter writer
- EMC noise reduction filter
- Other options are common to all models

#### 6. Extended power range

- Wide range of powers up to 75kW for this class of inverter.



## — Contents —

I	Safety precautions .....	1
II	Introduction .....	7
1.	Read first.....	A-1
1.1	Check product purchase .....	A-1
1.2	Contents of the product .....	A-2
1.3	Names and functions .....	A-3
1.4	Notes on the application .....	A-13
2.	Connection .....	B-1
2.1	Cautions on wiring .....	B-1
2.2	Standard connections .....	B-2
2.3	Description of terminals .....	B-5
3.	Operations .....	C-1
3.1	Simplified operation of the VF-FS1 .....	C-2
3.2	How to operate the VF-FS1 .....	C-6
4.	Basic VF-FS1 operations .....	D-1
4.1	Flow of status monitor mode .....	D-2
4.2	How to set parameters .....	D-3
5.	Basic parameters .....	E-1
5.1	Setting acceleration/deceleration time .....	E-1
5.2	Specifying an operation mode, using parameters .....	E-4
5.3	Selection of operation mode .....	E-7
5.4	Meter setting and adjustment .....	E-10
5.5	Standard default setting .....	E-13
5.6	Forward/reverse run selection (Operation panel operation) .....	E-15
5.7	Maximum frequency .....	E-16
5.8	Upper limit and lower limit frequencies .....	E-16
5.9	Base frequency .....	E-17
5.10	Selecting control mode .....	E-18
5.11	Manual torque boost - increasing torque boost at low speeds .....	E-24
5.12	Setting the electronic thermal .....	E-24
5.13	Preset-speed operation (speeds in 7 steps) .....	E-28
6.	Extended parameters .....	F-1
6.1	Input/output parameters .....	F-1
6.2	Input signal selection .....	F-5

6.3	Terminal function selection .....	F-6
6.4	Basic parameters 2 .....	F-15
6.5	Frequency priority selection .....	F-16
6.6	Operation frequency .....	F-24
6.7	DC braking .....	F-25
6.8	Auto-stop in case of lower-limit frequency continuous operation .....	F-26
6.9	Jump frequency-jumping resonant frequencies .....	F-28
6.10	Bumpless operation .....	F-29
6.11	PWM carrier frequency .....	F-30
6.12	Trip-less intensification .....	F-34
6.13	Drooping control .....	F-42
6.14	Conducting PID control .....	F-44
6.15	Setting motor constants .....	F-48
6.16	Acceleration/deceleration time 2 .....	F-53
6.17	Protection functions .....	F-57
6.18	Forced fire-speed control function .....	F-71
6.19	Adjustment parameters .....	F-72
6.20	Operation panel parameter .....	F-73
6.21	Communication function (RS485) .....	F-82
6.22	Parameters for options .....	F-87
6.23	Permanent magnetic motors .....	F-87
7.	Applied operation .....	G-1
7.1	Setting the operation frequency .....	G-1
7.2	Setting the operation mode .....	G-5
8.	Monitoring the operation status .....	H-1
8.1	Status monitor mode .....	H-1
8.2	Display of trip information .....	H-5
9.	Measures to satisfy the standards .....	I-1
9.1	How to cope with the CE directive .....	I-1
9.2	Compliance with UL Standard and CSA Standard .....	I-5
10.	Peripheral devices .....	J-1
10.1	Selection of wiring materials and devices .....	J-1
10.2	Installation of a magnetic contactor .....	J-3
10.3	Installation of an overload relay .....	J-4
10.4	Optional external devices .....	J-5
11.	Table of parameters and data .....	K-1
11.1	User parameters .....	K-1
11.2	Basic parameters .....	K-1
11.3	Extended parameters .....	K-4

12. Specifications .....	L-1
12.1 Models and their standard specifications .....	L-1
12.2 Outside dimensions and mass .....	L-4
13. Before making a service call - Trip information and remedies .....	M-1
13.1 Trip causes/warnings and remedies .....	M-1
13.2 Restoring the inverter from a trip .....	M-5
13.3 If the motor does not run while no trip message is displayed .....	M-6
13.4 How to determine the causes of other problems .....	M-7
14. Inspection and maintenance .....	N-1
14.1 Regular inspection .....	N-1
14.2 Periodical inspection .....	N-2
14.3 Making a call for servicing .....	N-5
14.4 Keeping the inverter in storage .....	N-5
15. Warranty .....	O-1
16. Disposal of the inverter .....	P-1

# 1. Read first

## 1.1 Check product purchase

Before using the product you have purchased, check to make sure that it is exactly what you ordered.

### ⚠ Caution



Mandatory

Use an inverter that conforms to the specifications of power supply and three-phase induction motor being used. If the inverter being used does not conform to those specifications, not only will the three-phase induction motor not rotate correctly, it may also cause serious accidents through overheating and fire.

1

#### Rating label

#### Inverter main unit

Series name

Power supply

Motor capacity

**VF-FS1**  
3PH-200/240V-0.75kW/1HP

Rating label

Warning label

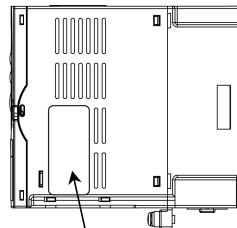
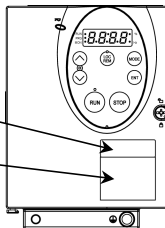

Name plate

#### Carton box

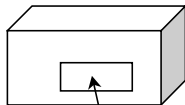

Type indication label

#### Warning label

⚠ 危険

- ・けが、感電、火災のおそれがあります。
- ・取り扱い説明書の注意事項を読むこと。
- ・遮量中及び電源断後10分以内は端子カバーを開けないこと。

**⚠ DANGER**

- ・Read the instruction manual.
- ・Do not open the cover while power is applied or for 10 minutes after power has been removed.

#### Name plate

Inverter Type  
Inverter rated output capacity  
Power supply  
Related input current  
Related output current

<b>TOSHIBA</b>	
TRANSISTOR INVERTER	
VF-FS1-2004PM-WN (1)	
0.4kW-1.1kVA-0.5HP	
<b>INPUT</b>	<b>OUTPUT</b>
U(V)	3PH 200/240 3PH 200/240
F(Hz)	50/60 0.5/200
I(A)	1.9/1.6 2.8
S.Ct 500VA FUSE 3A max Cu AWG14-75°C	
10.7lb-in/1.3Nm	
Serial No. 1550 01021303 0001	
Lot No. 05L 100MY50	
Made in Japan	
Motor Protective Device Class 10	
LISTED 170M IND. CONT. EQ.	
<b>TOSHIBA CORPORATION</b>	
T8J	

#### Instruction manual

This manual

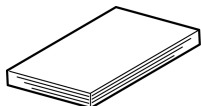

#### EMC plate

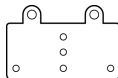

[ 18.5kW or less of WP models only ]

## 1.2 Contents of the product

Explanation of the name plate label.

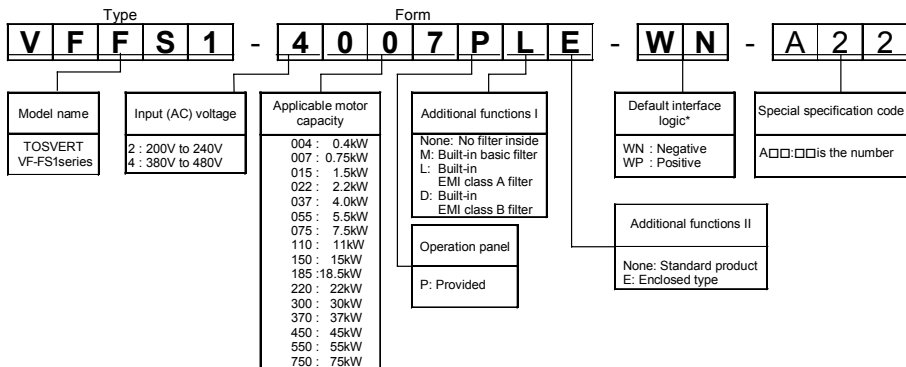

\* This code represents the factory default logic setting. You can switch from one input/output logic to the other using slide switch SW4. ⇒ See section 2.3.2.

Warning: Always shut power off first then check the ratings label of inverter held in a cabinet.

## 1.3 Names and functions

### 1.3.1 Outside view

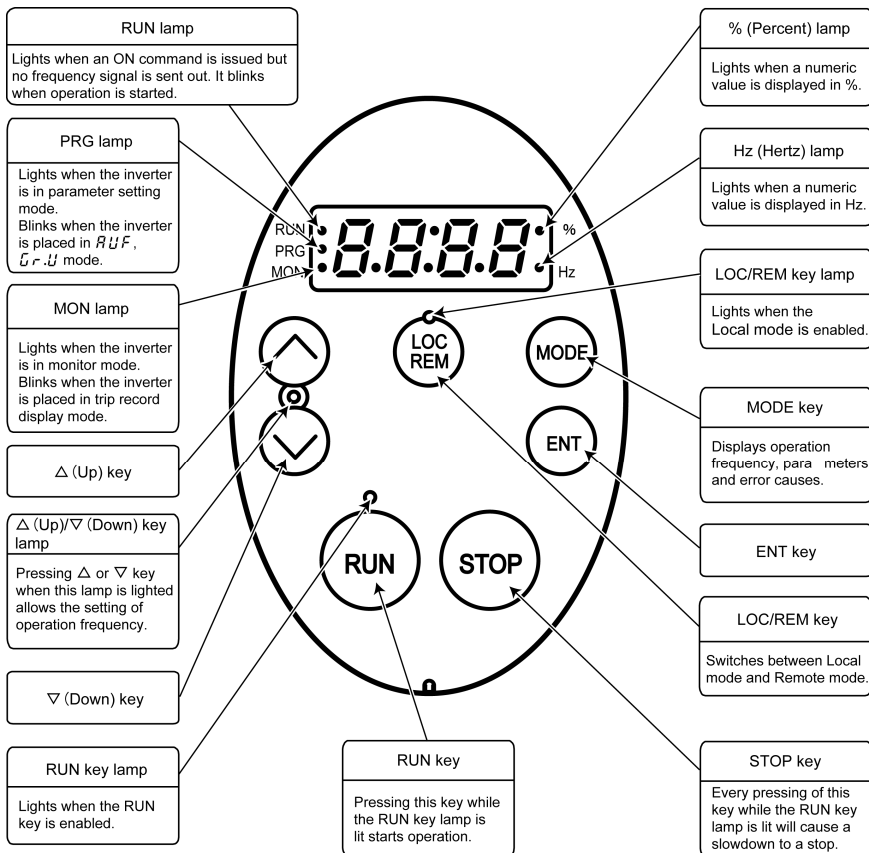

[Operation panel]

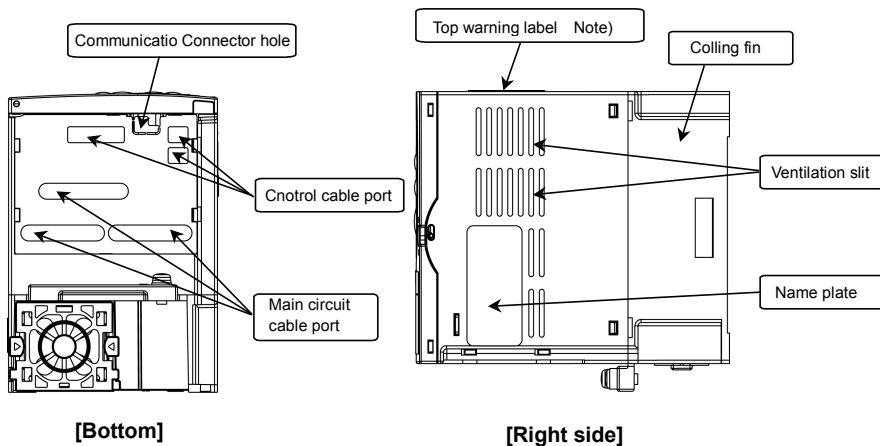
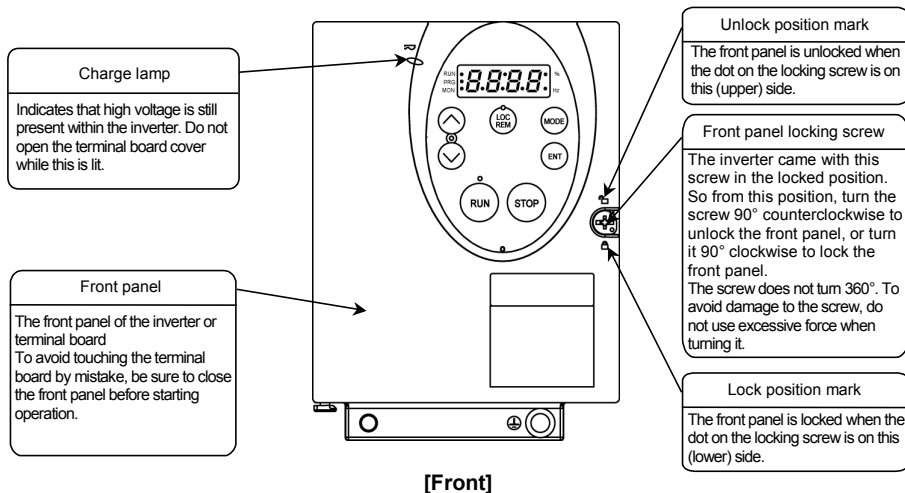

**Note:** Remove this seal and operate it at a current lower than the rated one when installing the inverter side by side with other inverters where the ambient temperature will rise above 40°C.

• **Monitor display**

The LEDs on the operation panel display the following symbols indicate operations and parameters.

LED(number)

0	1	2	3	4	5	6	7	8	9	-
0	1	2	3	4	5	6	7	8	9	-

LED(alphabet)

Aa	Bb	C	c	Dd	Ee	Ff	Gg	H	h	I	i	Jj	Kk	Ll
A	b	c	d	E	F	G	H	h	I	i	J	K	L	l
Mm	Nn	O	o	Pp	Qq	Rr	Ss	Tt	Uu	Vv	Ww	Xx	Yy	Zz
m	n	o	o	p	q	r	s	t	u	v	w	x	y	z

Example of the label

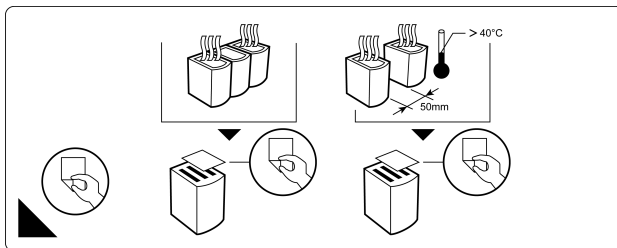

## 1.3.2 Power circuit and control circuit terminal boards

In case of the lug connector, cover the lug connector with insulated tube, or use the insulated lug connector.

### 1) Power circuit terminal board

In case of the lug connector, cover the lug connector with insulated tube, or use the insulated lug connector.

Screw size	tightening torque	
M4 screw	1.3Nm	10.7lb • in
M5 screw	2.5Nm	22.3lb • in
M6 screw	4.5Nm	40.1lb • in
M8 screw	12Nm	106lb • in
M12 screw	41Nm	360lb • in



VFFS1-2004 ~ 2037PM

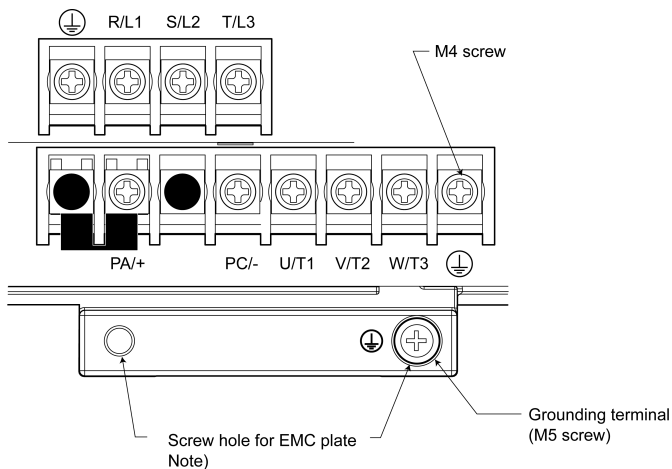

VFFS1-4004 ~ 4055PL

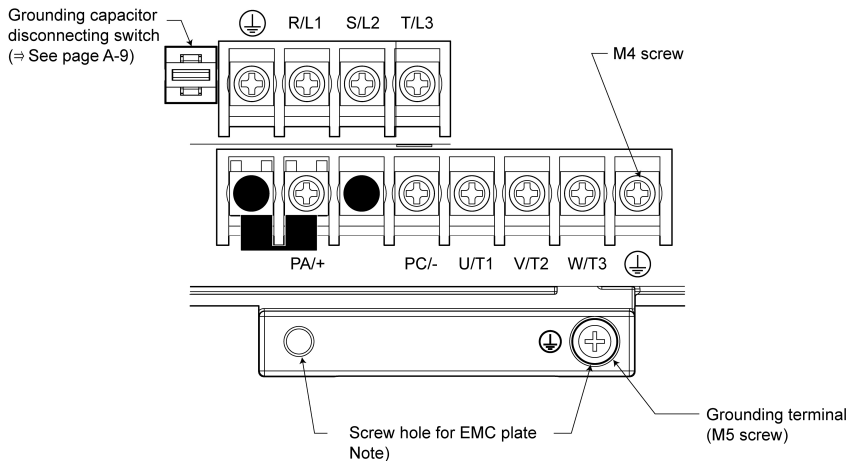

Note: EMC plate is supplied as standard only WP model.

VFFS1-2055, 2075PM  
-4075, 4110PL

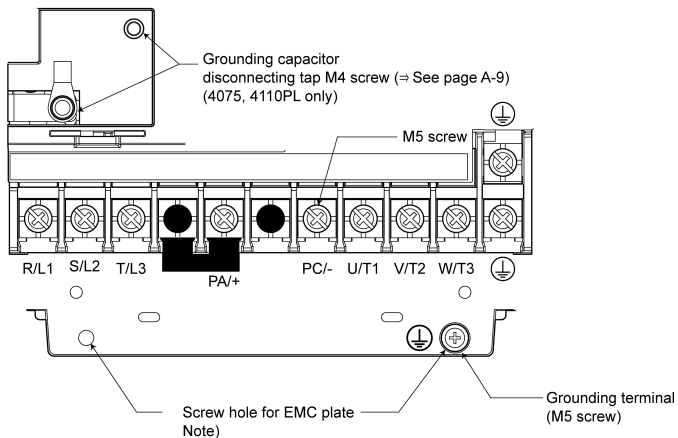

VFFS1-2110 ~ 2185PM  
-4150 ~ 4185PL

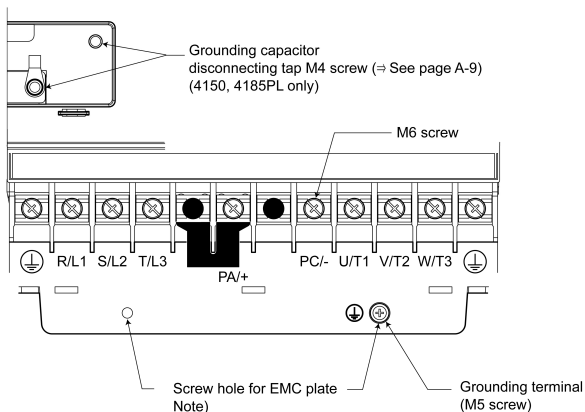

Note: EMC plate is supplied as standard only WP model.

VFFS1-2220PM  
-4220, 4300, 4370, 4450PL

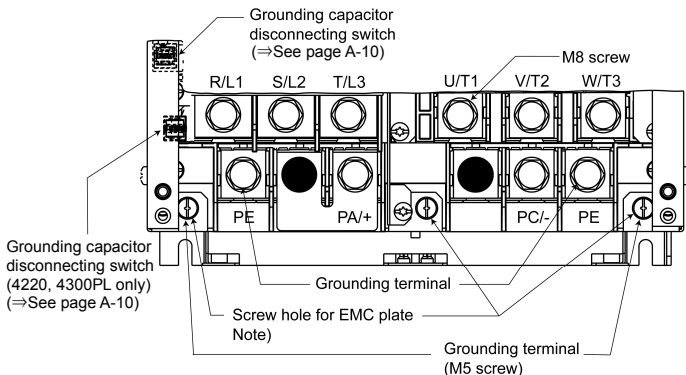

VFFS1-2300PM  
-4550, 4750PL

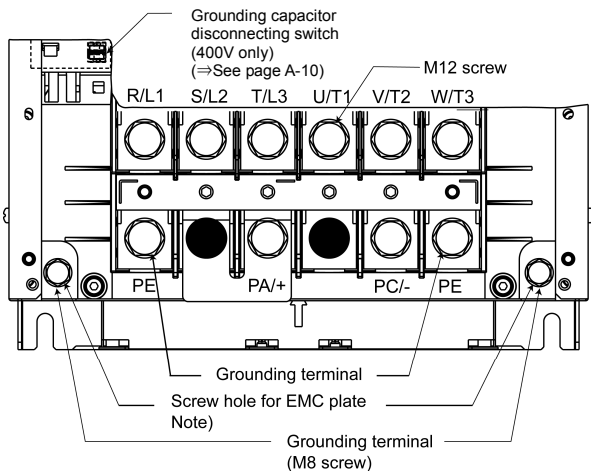

Each main circuit terminal has the structure shown in the figure below. Connect a cable to part A if it has a ring terminal, or to part B if it has no terminal (bare wire). Parts A and B accommodate different sizes of cables, so consult the cable size list for the size of cable connectable to each part.

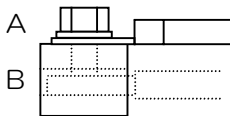

Note: EMC plate is supplied as option.

## 2) Grounding capacitor disconnecting switch and taps

 **Caution**

Mandatory

The grounding capacitor disconnecting tap is provided with a protection cover. To avoid shock hazards, always attach the cover after connecting or disconnecting the capacitor to or from the tap.

Every three-phase 400V model has a built-in high-attenuation noise filter, which is grounded through a capacitor.

If you want to disconnect the capacitor from the grounding line to reduce the amount of leakage current, you can do so easily using the switch or tap. Keep in mind, however, that disconnecting the capacitor from the grounding line causes the inverter to become non-compliant with the EMC directive. Also note that the inverter must always be turned off before the capacitor is disconnected or reconnected.

Note: In case of three phase 400V-5.5kW or less model, if you disconnect the capacitor from ground, set the parameter of carrier frequency  $F_{300}$  to 6kHz with motor cable length 30m or less.

## 5.5kW or less : Switch

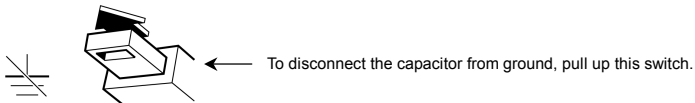
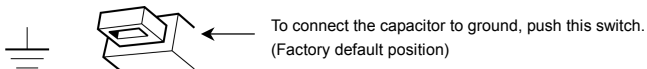

## 7.5~18.5kW: Tap

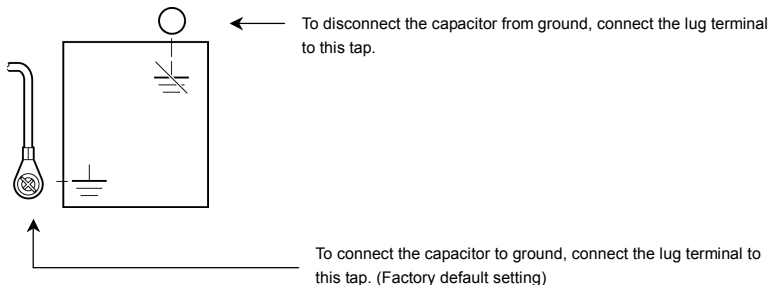

22kW or more: Switch

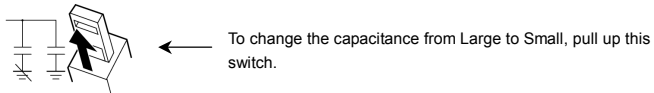
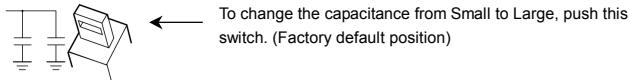

### 3) Control circuit terminal board

The control circuit terminal board is common to all equipment.

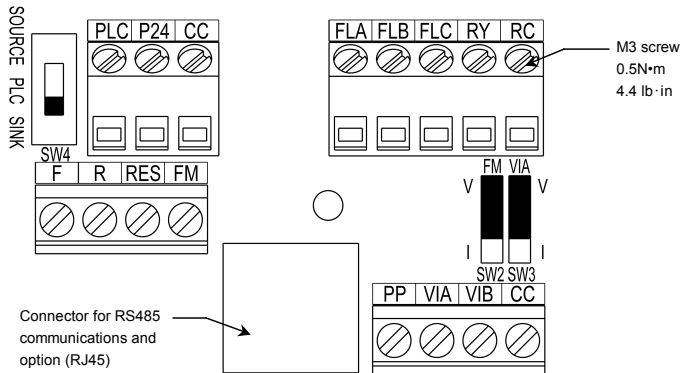

#### Wire size

Solid wire: 0.3 ~ 1.5 (mm<sup>2</sup>)

Stranded wire: 0.3 ~ 1.5 (mm<sup>2</sup>)  
(AWG 22 ~ 16)

Sheath strip length: 6 (mm)

Screwdriver: Small-sized flat-blade screwdriver

(Blade thickness: 0.6 mm or less, blade width: 3.5 mm or less)

#### Factory default settings of slide switches

SW4: SINK (Negative) side (WN type)

SOURCE (Positive) side (WP type)

FM (SW2): V side

VIA (SW3): V side

⇒ See section 2.3.2 for details on all terminal functions.

### 1.3.3 How to open the front (terminal board) cover-18.5kW or less

To wire the terminal board, remove the front lower cover in line with the steps given below.

(1)

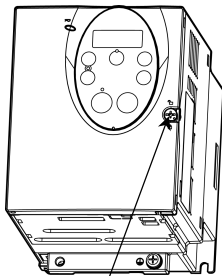

Turn the locking screw on the right side of the front panel 90° counterclockwise to align the dot on the screw with the unlock position mark (upper side). To avoid damage to the screw, do not apply excessive force to turn the screw more than 90 degrees.

(2)

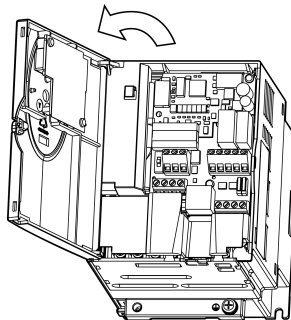

Pull the front panel toward you and swing it open to the left.

(3)

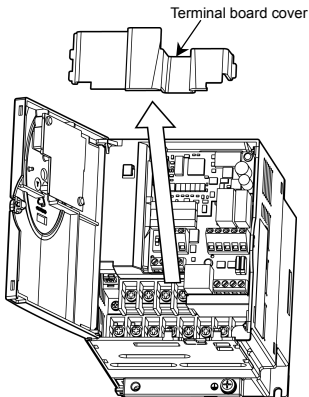

Remove the terminal board cover by pulling it up toward you.

(4)

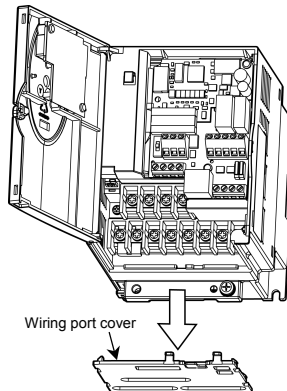

Remove the wiring port cover by pulling it down, pass cables through the wiring port, and connect the cables to the terminal board.

1

## 1.3.4 How to open the front (terminal board) cover-22kW or more

To wire the main circuit terminal board for models 22kW or more, remove the front cover.

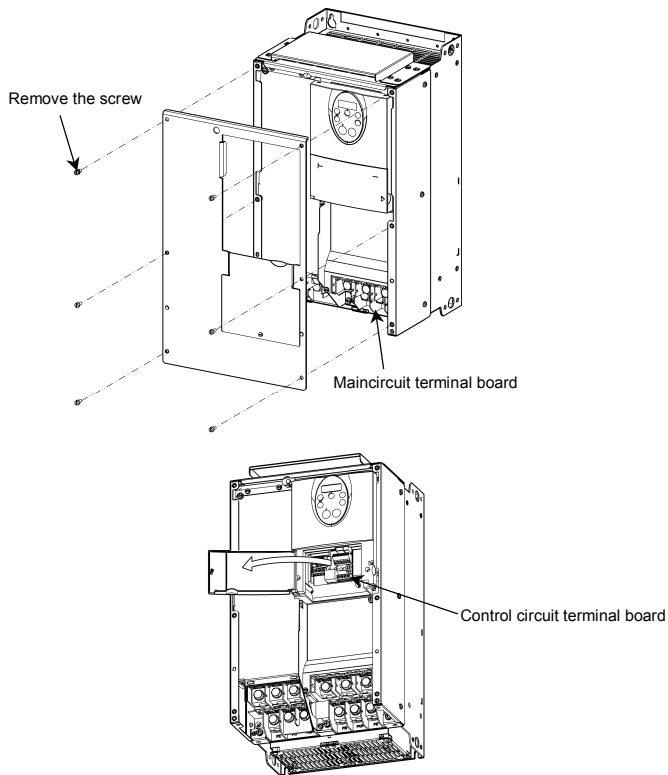



Open the control circuit terminal board cover.  
\* To open the cover, lift it with your finger placed at the  $\triangleright$  part on the right side of the cover.

## 1.4 Notes on the application

### 1.4.1 Motors

When the VF-FS1 and the motor are used in conjunction, pay attention to the following items.

 <b>Caution</b>	
 Mandatory	Use an inverter that conforms to the specifications of power supply and three-phase induction motor being used. If the inverter being used does not conform to those specifications, not only will the three-phase induction motor not rotate correctly, but it may cause serious accidents through overheating and fire.

#### Comparisons with commercial power operation.

The VF-FS1 Inverter employs the sinusoidal PWM system. However, the output voltage and output current are not perfect sine waves, they have a distorted wave that is close to sinusoidal waveform. This is why compared to operation with a commercial power there will be a slight increase in motor temperature, noise and vibration.

#### Operation in the low-speed area

When running continuously at low speed in conjunction with a general purpose motor, there may be a decline in that motor's cooling effect. If this happens, operate with the output decreased from rated load. To carry out low-speed operation continuously at the rated torque, we recommend to use a inverter rated motor or a forced cooled motor designed for use with an inverter. When operating in conjunction with a inverter rated motor, you must change the inverter's motor overload protection level to VF motor use (U L 7).

#### Adjusting the overload protection level

The VF-FS1 Inverter protects against overloads with its overload detection circuits (electronic thermal). The electronic thermal's reference current is set to the inverter's rated current, so it must be adjusted in line with the rated current of the general purpose motor being used in combination.

#### High speed operation at and above 60Hz

Operating at frequencies greater than 60Hz will increase noise and vibration. There is also a possibility this will exceed the motor's mechanical strength limits and the bearing limits so you should inquire to the motor's manufacturer about such operation.

#### Method of lubricating load mechanisms

Operating an oil-lubricated reduction gear and gear motor in the low-speed areas will worsen the lubricating effect. Check with the manufacturer of the reduction gear to find out about operable gearing area.



### Low loads and low inertia loads

The motor may demonstrate instability such as abnormal vibrations or overcurrent trips at light loads of 5 % or under of the load percentage, or when the load's inertia moment is extremely small. If that happens reduce the carrier frequency.

### Occurrence of instability

Unstable phenomena may occur with the load and motor combinations shown below.

- Combined with a motor that exceeds applicable motor ratings recommended for the inverter
- Combined with special motors

To deal with the above lower the settings of inverter carrier frequency.

- Combined with couplings between load devices and motors with high backlash

When using the inverter in the above combination, use the S-pattern acceleration/deceleration function, or when vector control is selected, adjust the speed control response/stability factor or switch to V/F control mode.

- Combined with loads that have sharp fluctuations in rotation such as piston movements

In this case, please do not use this inverter.

### Braking a motor when cutting off power supply

A motor with its power cut off goes into free-run, and does not stop immediately. To stop the motor quickly as soon as the power is cut off install an auxiliary brake. There are different kinds of brake devices, both electrical and mechanical. Select the brake that is best for the system.

### Load that produces regenerative torque

Do not use the inverter in combination with a load, such as an air conditioner, that produces regenerative torque. Or the overvoltage or overcurrent protection circuit of the inverter may be activated, causing the inverter to trip. If overvoltage tripping occurs during deceleration, lengthen the deceleration time.

## Braking motor

When using a braking motor, if the braking circuit is directly connected to the inverters's output terminals, the brake cannot be released because of the lowered starting voltage. Therefore, when using a braking motor, connect the braking circuit to the inverter's power supply side, as shown in the figure below. Usually, braking motors produce larger noise in low speed ranges.

**Note:** In the case of the circuit shown on the below, assign the function of detecting low-speed signals to the RY and RC terminals. Make sure the parameter  $F130$  is set to 4 (factory default setting).

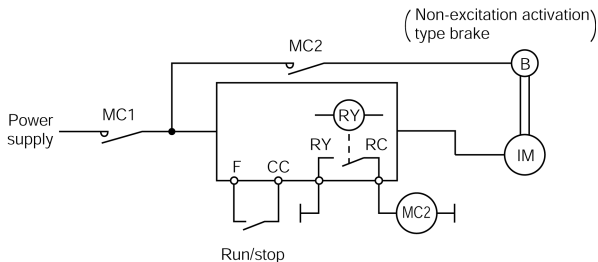

## Measures to protect motors against surge voltages

In a system in which a 400V-class inverter is used to control the operation of a motor, very high surge voltages may be produced. When applied to the motor coils repeatedly for a long time, may cause deterioration of their insulation, depending on the cable length, cable routing and types of cables used. Here are some examples of measures against surge voltages.

- (1) Lower the inverter's carrier frequency.
- (2) Set the parameter  $F315$  (Carrier frequency control mode selection) to 2 or 3.
- (3) Use a motor with high insulation strength.
- (4) Insert an AC reactor or a surge voltage suppression filter between the inverter and the motor.

## 1.4.2 Inverters

### Protecting inverters from overcurrent

The inverter has an overcurrent protection function. The programmed current level is set to the inverter's maximum applicable motor. If the motor used has a small capacity, the overcurrent level and the electronic thermal protection must be readjusted. If adjustment is necessary, see 5.12, and make adjustments as directed.

### Inverter capacity

Do not use a small-capacity (kVA) inverter to control the operation of a large-capacity motor, no matter how light the load is. Current ripple will raise the output peak current making it easier to set off the overcurrent trip.

## Power factor correction capacitor

Power factor correction capacitors cannot be installed on the output side of the inverter. When a motor is run that has a power factor correction capacitor attached to it, remove the capacitors. This can cause inverter malfunction trips and capacitor destruction.

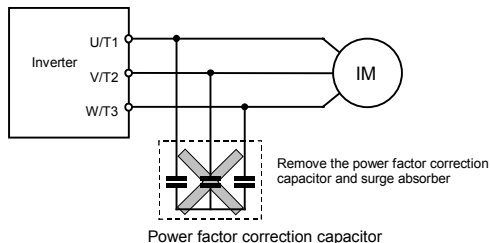

## Operating at other than rated voltage

Connections to voltages other than the rated voltage described in the rating label cannot be made. If a connection must be made to a power supply other than one with rated voltage, use a transformer to raise or lower the voltage to the rated voltage.

Circuit breaking when two or more inverters are used on the same power line.

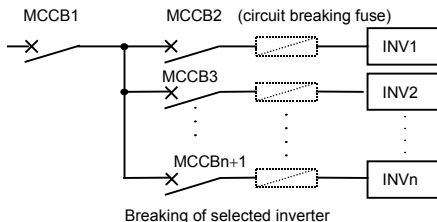

There is no fuse in the inverter's main circuit. Thus, as the diagram above shows, when more than one inverter is used on the same power line, you must select interrupting characteristics so that only the MCCB2 will trip and the MCCB1 will not trip when a short occurs in the inverter (INV1). When you cannot select the proper characteristics install a circuit interrupting fuse between the MCCB2 and the INV1.

## If power supply distortion is not negligible

If the power supply distortion is not negligible because the inverter shares a power distribution line with other systems causing distorted waves, such as systems with thyristors or large-capacity inverters, install an input reactor to improve the input power factor, to reduce higher harmonics, or to suppress external surges.

## ■ Disposal

If an inverter is no longer usable, dispose of it as industrial waste.

### 1.4.3 What to do about the leak current

#### Caution

Current may leak through the inverter's input/output wires because of insufficient electrostatic capacity on the motor with bad effects on peripheral equipment.

The leakage current's value is affected by the carrier frequency and the length of the input/output wires. Test and adopt the following remedies against leak current.

#### (1) Effects of leak current across ground

Leakage current may flow not just through the inverter system but also through ground wires to other systems. Leakage current will cause earth leakage breakers, leakage current relays, ground relays, fire alarms and sensors to operate improperly, and it will cause superimposed noise on the CRT screen or display of incorrect current detection with the CT.

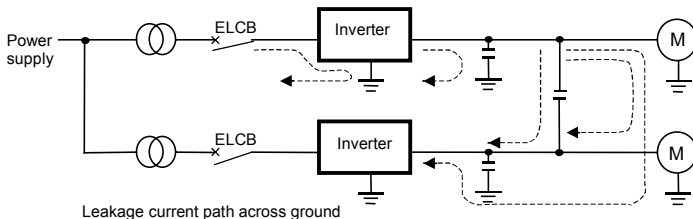

#### Remedies:

1. If there is no radio-frequency interference or similar problem, detach the built-in noise filter capacitor, using the grounding capacitor disconnecting switch or tap. → See section 1.3.2-2.
2. Reduce PWM carrier frequency.  
The setting of PWM carrier frequency is done with the parameter  $F300$ .  
Although the electromagnetic noise level is reduced, the motor acoustic noise is increased.
3. Use high frequency remedial products for earth leakage breakers.

## (2) Affects of leakage current across lines

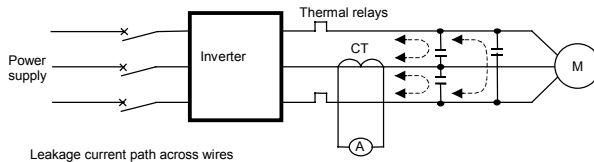

## (1) Thermal relays

The high frequency component of current leaking into electrostatic capacity between inverter output wires will increase the effective current values and make externally connected thermal relays operate improperly. If the wires are more than 50 meters long, it will be easy for the external thermal relay to operate improperly with models having motors of low rated current (several A(ampere) or less), especially the 400V class low capacity (5.5kW or less) models, because the leak current will increase in proportion to the motor rating.

## Remedies:

1. Use the electronic thermal built into the inverter. ⇒ See section 5.12.

The setting of the electronic thermal is done using parameter  $\theta L \eta, t H r$ .

2. Reduce the inverter's PWM carrier frequency. However, that will increase the motor's magnetic noise.

The setting of PWM carrier frequency is done with the parameter  $F 3 Q Q$ . ⇒ See section 6.11.

3. This can be improved by installing 0.1 $\mu$ -0.5 $\mu$ F - 1000V film capacitor to the input/output terminals of each phase in the thermal relay.

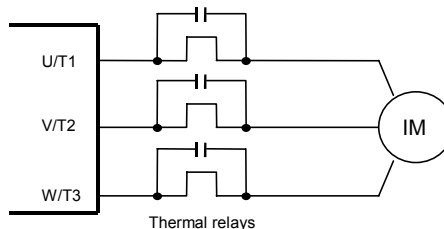

## (2) CT and ammeter

If a CT and ammeter are connected externally to detect inverter output current, the leak current's high frequency component may destroy the ammeter. If the wires are more than 50 meters long, it will be easy for the high frequency component to pass through the externally connected CT and be superimposed on and burn the ammeter with models having motors of low rated current (several A(ampere) or less), especially the 400V class low capacity (5.5kW or less) models, because the leak current will increase in proportion to the motor's rated current.

## Remedies:

1. Use a meter output terminal in the inverter control circuit.

The load current can be output on the meter output terminal (FM). If the meter is connected, use an ammeter of 1mAdc full scale or a voltmeter of 7.5V(10V)-1mA full scale. 0-20mAdc (4-20mAdc) can be also output. → See section 5.4.

2. Use the monitor functions built into the inverter.



Use the monitor functions on the panel built into the inverter to check current values.



⇒ See section 8.1.1.

## 1.4.4 Installation

### ■ Installation environment

The VF-FS1 Inverter is an electronic control instrument. Take full consideration to installing it in the proper operating environment.

 Warning	
 Prohibited	<ul style="list-style-type: none"> <li>Do not place any inflammable substances near the VF-FS1 Inverter. If an accident occurs in which flame is emitted, this could lead to fire.</li> </ul>
 Mandatory	<ul style="list-style-type: none"> <li>Operate under the environmental conditions prescribed in the instruction manual. Operations under any other conditions may result in malfunction.</li> </ul>

 Caution	
 Prohibited	<ul style="list-style-type: none"> <li>Do not install the VF-FS1 Inverter in any location subject to large amounts of vibration. This could cause the unit to fall, resulting in bodily injury.</li> </ul>
 Mandatory	<ul style="list-style-type: none"> <li>Check to make sure that the input power voltage is +10%, -15% of the rated power voltage written on the rating label (±10% when the load is 100% in continuous operation) if the input power voltage is not +10%, -15% of the rated power voltage (±10% when the load is 100% in continuous operation) this may result in fire.</li> </ul>



- Do not install in any location of high temperature, high humidity, moisture condensation and freezing and avoid locations where there is exposure to water and/or where there may be large amounts of dust, metallic fragments and oil mist.
- Do not install in any location where corrosive gases or grinding fluids are present.

- 1
- Operate in areas where ambient temperature ranges from  $-10^{\circ}\text{C}$  to  $60^{\circ}\text{C}$ .  
When installing the inverter where the ambient temperature will rise above  $40^{\circ}\text{C}$ , remove the label (seal) from the top and operate it at a current lower than the rated one.

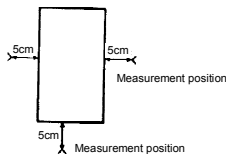

Note: The inverter is a heat-emitting body. Make sure proper space and ventilation is provided when installing in the cabinet. When installing inside a cabinet, we recommend the top seal peeled off although  $40^{\circ}\text{C}$  or less.

- Do not install in any location that is subject to large amounts of vibration.





Note: If the VF-FS1 Inverter is installed in a location that is subject to vibration, anti-vibration measures are required. Please consult with Toshiba about these measures.

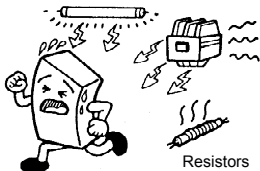

- If the VF-FS1 Inverter is installed near any of the equipment listed below, provide measures to insure against errors in operation.



- |                      |                                      |
|----------------------|--------------------------------------|
| Solenoids:           | Attach surge suppressor on coil.     |
| Brakes:              | Attach surge suppressor on coil.     |
| Magnetic contactors: | Attach surge suppressor on coil.     |
| Fluorescent lights:  | Attach surge suppressor on coil.     |
| Resistors:           | Place far away from VF-FS1 Inverter. |

## ■ How to install

 Warning	
 Prohibited	<ul style="list-style-type: none"> <li>Do not install or operate the inverter if it is damaged or any component is missing. This can result in electric shock or fire. Please consult your local sales agency for repairs. Call your local sales agency for repairs.</li> </ul>
 Mandatory	<ul style="list-style-type: none"> <li>Mount the inverter on a metal plate. The rear panel gets very hot. Do not install in an inflammable object, this can result in fire.</li> <li>Do not operate with the front panel cover removed. This can result in electric shock.</li> <li>An emergency stop device must be installed that fits with system specifications (e.g. shut off input power then engage mechanical brake). Operation cannot be stopped immediately by the inverter alone, thus risking an accident or injury.</li> <li>All options used must be those specified by Toshiba. The use of any other option may result in an accident.</li> </ul>

 Caution	
 Mandatory	<ul style="list-style-type: none"> <li>The main unit must be installed on a base that can bear the unit's weight. If the unit is installed on a base that cannot withstand that weight, the unit may fall resulting in injury.</li> <li>If braking is necessary (to hold motor shaft), install a mechanical brake. The brake on the inverter will not function as a mechanical hold, and if used for that purpose, injury may result.</li> </ul>

Install the inverter in a well-ventilated indoor place and mount it on a flat metal plate in portrait orientation. If you are installing more than one inverter, the separation between inverters should be at least 5 centimeters, and they should be arranged in horizontal rows. If the inverters are horizontally arranged with no space between them (side-by-side installation), peel off the ventilation seals on top of the inverter. It is necessary to decrease the current if the inverter is operated at over 40°C.

### ●Standard installation

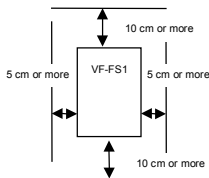

### ●Side-by-side installation

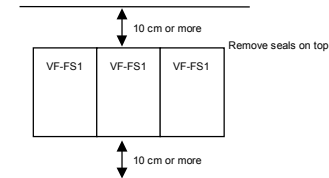

The space shown in the diagram is the minimum allowable space. Because air cooled equipment has cooling fans built in on the top or bottom surfaces, make the space on top and bottom as large as possible to allow for air passage.

Note: Do not install in any location where there is high humidity or high temperatures and where there are large amounts of dust, metallic fragments and oil mist.



## ■ Calorific values of the inverter and the required ventilation

About 5% of the rated power of the inverter will be lost as a result of conversion from AC to DC or from DC to AC. In order to suppress the rise in temperature inside the cabinet when this loss becomes heat loss, the interior of the cabinet must be ventilated and cooled.

The amount of forcible air-cooling ventilation required and the necessary heat discharge surface quantity when operating in a sealed cabinet according to motor capacity are as follows.

Note1: The heat loss for the optional external devices (input reactor, radio noise reduction filters, etc.) is not included in the calorific values in the table

Note2: Case of 100% Load Continuation operation.

Voltage class	Operating motor capacity (kW)	Calorific Values (w)		Amount of forcible air cooling ventilation required (m <sup>3</sup> /min)	Heat discharge surface area required for sealed storage cabinet(m <sup>2</sup> )
		Carrier frequency 8kHz	Carrier frequency 12kHz		
Three-Phase 200V class	0.4	-	44	0.25	0.88
	0.75	-	63	0.36	1.26
	1.5	-	101	0.58	2.02
	2.2	-	120	0.68	2.4
	4.0	-	193	1.1	3.86
	5.5	-	249	1.42	4.98
	7.5	-	346	1.97	6.92
	11	-	459	2.62	9.18
	15	-	629	3.59	12.58
	18.5	698	-	3.98	13.96
	22	763	-	4.35	15.26
	30	1085	-	6.18	21.7
	40	-	45	0.26	0.9
	45	-	55	0.31	1.1
Three-Phase 400V class	1.5	-	78	0.44	1.56
	2.2	-	103	0.59	2.06
	4.0	-	176	1.0	3.52
	5.5	-	215	1.23	4.3
	7.5	-	291	1.66	5.82
	11	-	430	2.45	8.6
	15	-	625	3.56	12.5
	18.5	603	-	3.44	12.06
	22	626	-	3.57	12.52
	30	847	-	4.83	16.94
	37	980	-	5.59	19.60
	45	1257	-	7.17	25.14
	55	1459	-	8.32	29.18
	75	1949	-	11.11	38.98

## ■ Panel designing taking into consideration the effects of noise

The inverter generates high frequency noise. When designing the control panel setup, consideration must be given to that noise. Examples of measures are given below.

- Wire so that the main circuit wires and the control circuit wires are separated. Do not place them in the same conduit, do not run them parallel, and do not bundle them.
- Provide shielding and twisted wire for control circuit wiring.

- Separate the input (power) and output (motor) wires of the main circuit. Do not place them in the same conduit, do not run them parallel, and do not bundle them.
- Ground the inverter ground terminals (⏏).
- Install surge suppressor on any magnetic contactor and relay coils used around the inverter.
- Install noise filters if necessary.
- Install EMC plate and use shielded wires.

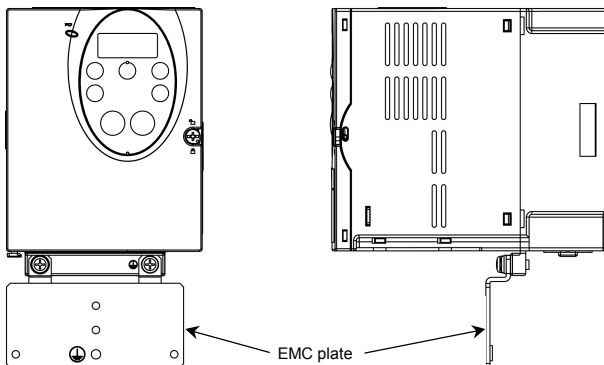

## ■ Installing more than one unit in a cabinet

If you are installing two or more inverters in one cabinet, pay attention to the following.



- Inverters may be installed side by side with each other with no space left between them.
- When installing inverters side by side, detach the caution label on the top surface of each inverter and use them where the ambient temperature will not rise above 40°C.

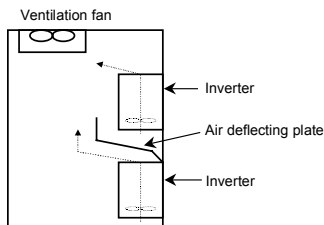

When using inverters where the ambient temperature will rise above 40°C, leave a space of 5 cm or more between them and remove the caution label from the top of each inverter, and operate each inverter at a current lower than the rated one.

- Ensure a space of at least 20 centimeters on the top and bottom of the inverters.
- Install an air deflecting plate so that the heat rising up from the inverter on the bottom does not affect the inverter on the top.







## 2. Connection



 <b>Warning</b>	
 Disassembly prohibited	<ul style="list-style-type: none"> <li>Never disassemble, modify or repair. This can result in electric shock, fire and injury. For repairs, call your sales agency.</li> </ul>
 Prohibited	<ul style="list-style-type: none"> <li>Don't stick your fingers into openings such as cable wiring hole and cooling fan covers. This can result in electric shock or other injury.</li> <li>Don't place or insert any kind of object into the inverter (electrical wire cuttings, rods, wires). This can result in electric shock or fire.</li> <li>Do not allow water or any other fluid to come in contact with the inverter. That may result in electric shock or fire.</li> </ul>

 <b>Caution</b>	
 Prohibited	<ul style="list-style-type: none"> <li>When transporting or carrying, do not hold by the front panel covers. The covers may come off and the unit will drop out resulting in injury.</li> </ul>

### 2.1 Cautions on wiring

 <b>Warning</b>	
 Prohibited	<ul style="list-style-type: none"> <li>Never remove the front cover when power is on or open door if enclosed in a cabinet. The unit contains many high voltage parts and contact with them will result in electric shock.</li> </ul>
 Mandatory	<ul style="list-style-type: none"> <li>Turn power on only after attaching the front cover or closing door if enclosed in a cabinet. If power is turned on without the front cover attached or closing door if enclosed in a cabinet. This can result in electric shock or other injury.</li> <li>Electrical construction work must be done by a qualified expert. Connection of input power by someone who does not have that expert knowledge may result in fire or electric shock.</li> <li>Connect output terminals (motor side) correctly. If the phase sequence is incorrect, the motor will operate in reverse and that may result in injury.</li> <li>Wiring must be done after installation.</li> <li>If wiring is done prior to installation that may result in injury or electric shock.</li> <li>The following steps must be performed before wiring.             <ol style="list-style-type: none"> <li>(1) Shut off all input power.</li> <li>(2) Wait at least ten minutes and check to make sure that the charge lamp is no longer lit.</li> <li>(3) Use a tester that can measure DC voltage (800VDC or more), and check to make sure that the voltage to the DC main circuits (across PA/+ and PC/-) is 45V or less.</li> </ol>             If these steps are not properly performed, the wiring will cause electric shock.           </li> <li>Tighten the screws on the terminal board to specified torque. If the screws are not tightened to the specified torque, it may lead to fire.</li> </ul>

 <b>Warning</b>	
 Be Grounded	<ul style="list-style-type: none"> <li>• Ground must be connected securely. If the ground is not securely connected, it could lead to electric shock or fire when a malfunction or current leak occurs.</li> </ul>

 <b>Caution</b>	
 Prohibited	<ul style="list-style-type: none"> <li>• Do not attach devices with built-in capacitors (such as noise filters or surge absorber) to the output (motor side) terminal. This could cause a fire.</li> </ul>

### ■ Preventing radio noise

To prevent electrical interference such as radio noise, separately bundle wires to the main circuit's power terminals (R/L1, S/L2, T/L3) and wires to the motor terminals (U/T1, V/T2, W/T3).

### ■ Control and main power supply

The control power supply and the main circuit power supply for the VF-FS1 are the same.



⇒ See section 6.17.3.

If a malfunction or trip causes the main circuit to be shut off, control power will also be shut off. When checking the cause of the malfunction or the trip, use the trip holding retention selection parameter.

### ■ Wiring

- Because the space between the main circuit terminals is small use sleeved pressure terminals for the connections. Connect the terminals so that adjacent terminals do not touch each other.
- For ground terminal (⊕) use wires of the size that is equivalent to or larger than those given in table 10.1 and always ground the inverter (200V voltage class: D type ground, 400V class: C type ground). Use as large and short a ground wire as possible and wire it as close as possible to the inverter.
- For the sizes of electric wires used in the main circuit, see the table in 10.1.
- The length of the main circuit wire in 10.1 should be no longer than 30 meters. If the wire is longer than 30 meters, the wire size (diameter) must be increased.

## 2.2 Standard connections

 <b>Warning</b>	
 Prohibited	<ul style="list-style-type: none"> <li>• Do not connect input power to the output (motor side) terminals (U/T1, V/T2, W/T3). Connecting input power to the output could destroy the inverter or cause a fire.</li> <li>• Do not insert a resistor between DC terminals (between PA/+ and PC/-). It could cause a fire.</li> <li>• First shut off input power and wait at least 10 minutes before touching wires on equipment (MCCB) that is connected to inverter power side. Touching the wires before that time could result in electric shock.</li> </ul>

## 2.2.1 Standard connection diagram 1

This diagram shows a standard wiring of the main circuit.

Standard connection diagram - SINK (Negative) (common:CC)

2

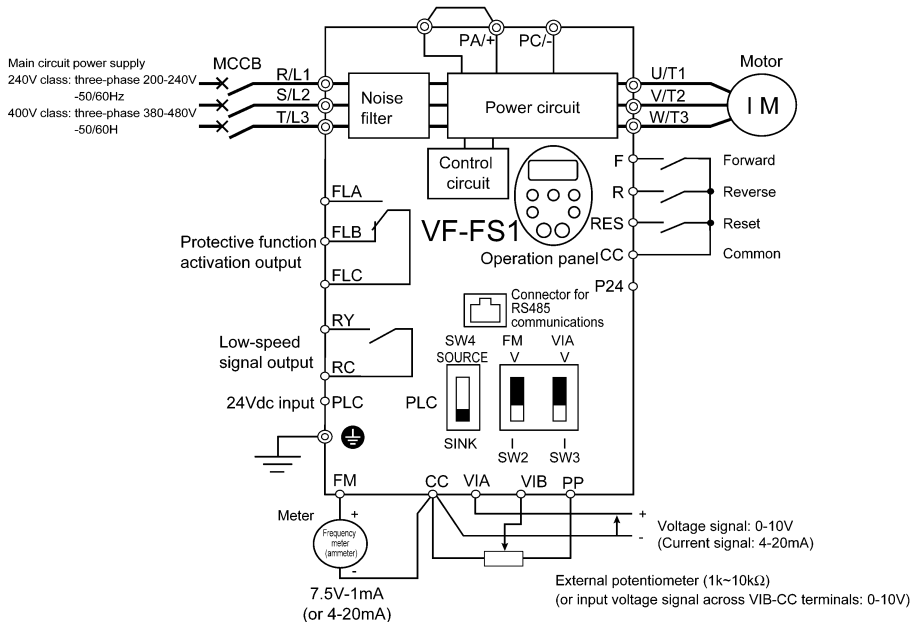

## 2.2.2 Standard connection diagram 2

Standard connection diagram - SOURCE (Positive) (common:P24)

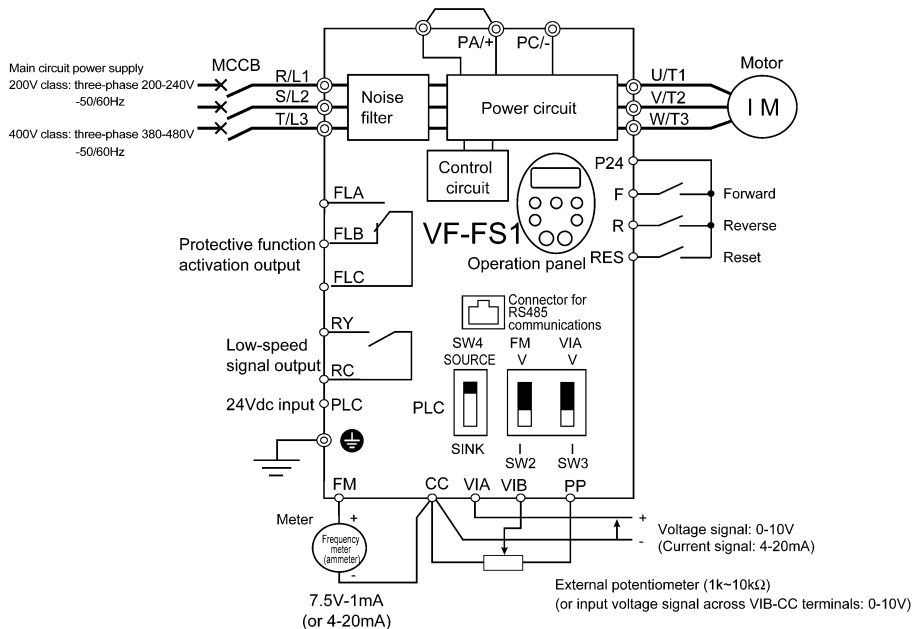

## 2.3 Description of terminals

### 2.3.1 Power circuit terminals

This diagram shows an example of wiring of the main circuit. Use options if necessary.

#### ■ Power supply and motor connections

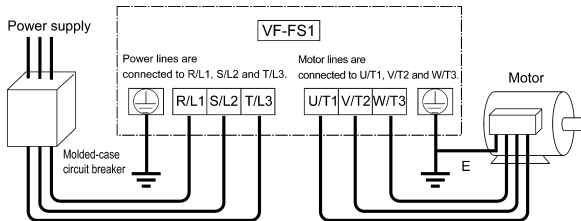

#### ■ Connections with peripheral equipment

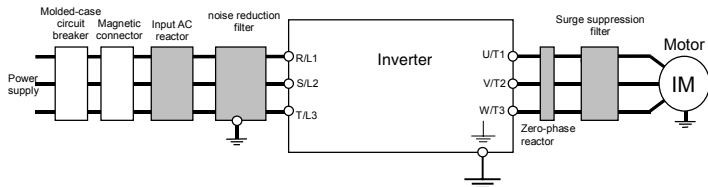

## ■ Power circuit

Terminal symbol	Terminal function
 (PE)	Grounding terminal for connecting inverter. There are 3 terminals in total. 2 terminals in the terminal board, 1 terminal in the cooling fin.
R/L1,S/L2,T/L3	200V class: three-phase 200 to 240V-50/60Hz 400V class: three-phase 380 to 480V-50/60Hz
U/T1,V/T2,W/T3	Connect to a (three-phase induction) motor.
PA+, PC/-	PA+ terminal: Positive potential terminal for the internal DC main circuit PC/- terminal: Negative potential terminal for the internal DC main circuit DC power can be supplied through the PA+ and PC/- terminals. (22kW and more: Do not connect the DC power supply)

The arrangement of power circuit terminals are different from each range.

⇒ See section 1.3.2.1) about the arrangement of power circuit terminals.

## 2.3.2 Control circuit terminals

The control circuit terminal board is common to all equipment.

Regarding to the function and specification of each terminal, please refer to the following table.

⇒ See section 1.3.2.3) about the arrangement of control circuit terminals.

### ■ Control circuit terminals

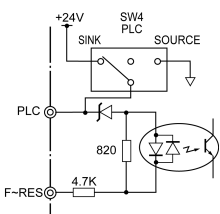
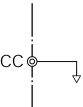
Terminal symbol	Input/output	Function	Electrical specifications	Inverter internal circuits	
F	Input	Multifunction programmable contact input	No voltage contact input 24Vdc-5mA or less  *Sink/Source/PLC selectable using SW4		
R	Input				Shorting across F-CC causes forward rotation; open causes slow-down and stop. (When ST is always ON)
RES	Input				Shorting across R-CC causes reverse rotation; open causes slow-down and stop. (When ST is always ON)  This inverter protective function is disabled if RES are CC is connected. Shorting RES and CC has no effect when the inverter is in a normal condition.
PLC	Input (common)	External 24Vdc power input When the source logic is used, a common terminal is connected.	24VDC (Insulation resistance: DC50V)	Factory default setting WN type : SINK side WP type : SOURCE side	
CC	Common to Input/output	Control circuit's equipotential terminal (2 terminals)			



Terminal symbol	Input/output	Function	Electrical specifications	Inverter internal circuits
PP	Output	Analog power supply output	10Vdc (permissible load current: 10mA)	
VIA	Input	Multifunction programmable analog input. Factory default setting: 0~10Vdc/0~60Hz (0~50Hz) frequency input. The function can be changed to 4~20mA (0~20mA) current input by flipping the VIA (SW3) dip switch to the I position.  By changing parameter setting, this terminal can also be used as a multifunction programmable contact input terminal. When using the sink logic, be sure to insert a resistor between P24-VIA (4.7 kΩ-1/2 W). Also move the VIA (SW3) dip switch to the V position.	10Vdc (internal impedance: 30kΩ)  4-20mA (internal impedance: 250Ω)	
VIB	Input	Multifunction programmable analog input. Standard default setting: 0~10Vdc/0~60Hz (0~50Hz) frequency input. PTC thermal input ⇒ See section 6.17.15.	10Vdc (internal impedance: 30kΩ)	
FM	Output	Multifunction programmable analog output. Standard default setting: output frequency. The function can be changed to 0-20mA (4-20mA) current output by flipping the FM (SW2) slide switch to the I position.	1mA Avc full-scale ammeter or 7.5Vdc (10Vdc) 1mA full-scale voltmeter  0-20mA (4-20mA) DC ammeter  Permissible load resistance: 750Ω or less	
P24	Output	24Vdc power output	24Vdc-50mA	

\* PTC (Positive Temperature Coefficient) : Resettable thermal fuse resistor for over current protection

Terminal symbol	Input/output	Function	Electrical specifications	Inverter internal circuits
FLA FLB FLC	Output	Multifunction programmable relay contact output. Detects the operation of the inverter's protection function. Contact across FLA-FLC is closed and FLB-FLC is opened during protection function operation.	250Vac-1A ( $\cos\phi=1$ ) : at resistance load 30Vdc-0.5A 250Vac-0.5A ( $\cos\phi=0.4$ )	
RY RC	Output	Multifunction programmable relay contact output. Standard default settings detect and output low-speed signal output frequencies. Multifunction output terminals to which two different functions can be assigned.	250Vac-1A ( $\cos\phi=1$ ) : at resistance load 30Vdc-0.5A 250Vac-0.5A ( $\cos\phi=0.4$ )	

■ **SINK (Negative) logic/SOURCE (Positive) logic (When the inverter's internal power supply is used)**

Current flowing out turns control input terminals. These are called sink logic terminals.

The general used method in Europe is source logic in which current flowing into the input terminal turns it on.

Sink logic is sometimes referred to as negative logic, and source logic is referred to as positive logic.

Each logic is supplied with electricity from either the inverter's internal power supply or an external power supply, and its connections vary depending on the power supply used.

<Examples of connections when the inverter's internal power supply is used>

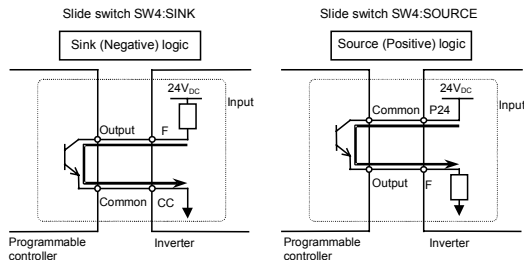

- SINK (Negative) logic/SOURCE (Positive) logic (When an external power supply is used)

The PLC terminal is used to connect to an external power supply or to insulate a terminal from other input or output terminals. As for input terminals, turn the SW4 slide switch to the PLC position.

<Examples of connections when an external power supply is used>

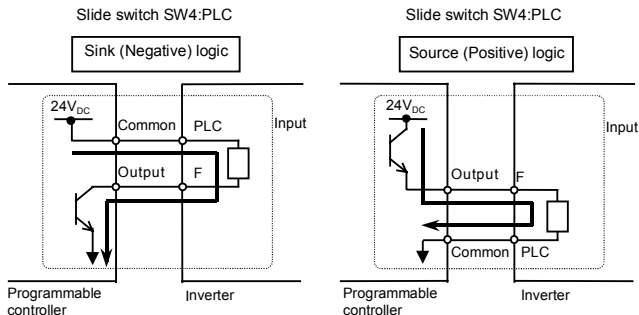

- Selecting the functions of the VIA terminals between analog input and contact input

The functions of the VIA terminal can be selected between analog input and contact input by changing parameter settings ( $F$  109). (Factory default setting: Analog input)

When using these terminals as contact input terminals in a sink logic circuit, be sure to insert a resistor between the P24 and VIA terminals. (Recommended resistance:  $4.7K\Omega$ -1/2W)

In case source (Positive) logic circuit, connect the resistor between VIA and CC terminals.

When using the VIA terminal as a contact input terminal, be sure to turn the VIA (SW3) switch to the V position. If no resistor is inserted or the VIA (SW3) slide switch is not turned to the V position, contact input will be left always ON, which is very dangerous.

Switch between analog input and contact input before connecting the terminals to the control circuit terminals. Otherwise the inverter or devices connected to it may be damaged.

★ The figure on the right shows an example of the connection of input terminals VIA when there is used as contact input terminals. This example illustrates the connection when the inverter is used in sink (Negative) logic mode.

★ In case source (Positive) logic mode, connect the resistor between VIA and CC.

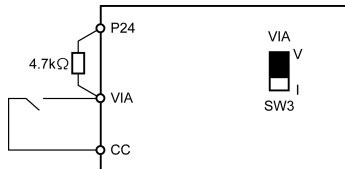

2

■ Logic switching/Voltage-current output switching (slide switch)

(1) Logic switching

Use SW4 to switch between logics.

Switch between logics before wiring to the inverter and without supplying power. If switching between sink, source and PLC is done when power is turned on after switching or when the inverter is supplied with power, the inverter might become damaged. Confirm it before supplying power.

(2) Voltage-current output switching

Use the FM (SW2) switch to switch between voltage output and current output.

Switch the FM terminal's voltage-current output before wiring to inverter or without supplying power.

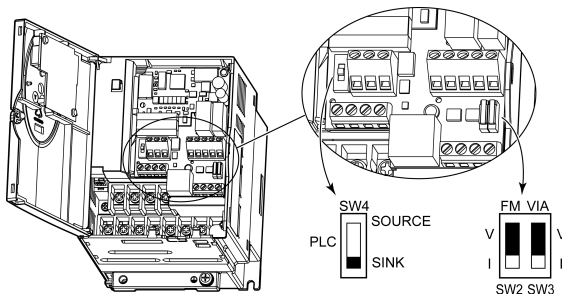

Factory default settings of slide switches



SW4 : SINK (Negative) side (WN type)



SOURCE (Positive) side (WP type)

FM (SW2): V side

VIA (SW3): V side

### 3. Operations

 <b>Warning</b>	
 Prohibited	<ul style="list-style-type: none"> <li>• Do not touch inverter terminals when electrical power is going to the inverter even if the motor is stopped. Touching the inverter terminals while power is connected to it may result in electric shock.</li> <li>• Do not touch switches when the hands are wet and do not try to clean the inverter with a damp cloth. Such practices may result in electric shock.</li> <li>• Do not go near the motor in alarm-stop status when the retry function is selected. The motor may suddenly restart and that could result in injury. Take measures for safety, e.g. attaching a cover to the motor, against accidents when the motor unexpectedly restarts.</li> </ul>
 Mandatory	<ul style="list-style-type: none"> <li>• Turn power on only after attaching the front cover or closing door if enclosed in a cabinet. If power is turned on without the front cover attached or closing door if enclosed in a cabinet, that may result in electric shock or other injury.</li> <li>• If the inverter begins to emit smoke or an unusual odor, or unusual sounds, immediately turn power off. If the equipment is continued in operation in such a state, the result may be fire. Call your local sales agency for repairs.</li> <li>• Always turn power off if the inverter is not used for long periods of time.</li> <li>• Turn input power on after attaching the front cover. When enclosed inside a cabinet and using with the front cover removed, always close the cabinet doors first and then turn power on. If the power is turned on with the front cover or the cabinet doors open, it may result in electric shock.</li> <li>• Make sure that operation signals are off before resetting the inverter after malfunction. If the inverter is reset before turning off the operating signal, the motor may restart suddenly causing injury.</li> </ul>

 <b>Caution</b>	
 Contact prohibited	<ul style="list-style-type: none"> <li>• Do not touch heat radiating fins or discharge resistors. These device are hot, and you'll get burned if you touch them.</li> </ul>
 Prohibited	<ul style="list-style-type: none"> <li>• Observe all permissible operating ranges of motors and mechanical equipment. (Refer to the motor's instruction manual.) Not observing these ranges may result in injury.</li> </ul>

## 3.1 Simplified Operation of the VF-FS1

The procedures for setting operation frequency and the methods of operation can be selected from the following.

Start / Stop

- : (1) Run and stop from the operation panel
- (2) Run and stop using external signals to the terminal board
- (3) Run and stop through RS485 communication

Setting the frequency

- : (1) Setting using the operation panel
- (2) Setting using external signals to the terminal board (0-10Vdc, 4-20mAdc)
- (3) Setting through RS485 communication
- (4) Setting using external contact up/down

### Local mode and Remote mode



**Local mode** : When Local mode selected by key, start and stop, and frequency setting are effective only by operation panel keys.  
The LOC/REM key lamp is lit while Local mode selected.

**Remote mode** : Start and stop, and frequency setting follow the selection of  $\text{C} \text{M} \text{D}$  (Command mode), or  $\text{F} \text{R} \text{Q}$  (Frequency setting mode).

\*1 At default setting, the switching between Local mode and Remote mode is effective. When prohibiting this function, refer to the chapter 6.20.1.

\*2 At default setting, when switched from remote of start or stop and running frequency at Remote mode are shifted to Local mode. When changing from Local mode to Remote mode, the inverter can start in case of running mode selection at remote side. In case of prohibiting this function.  $\Rightarrow$  See section 6.10.

\*3 The status of Local/Remote mode is memoried when power off.

Remote mode selection, use the basic parameters  $\text{C} \text{M} \text{D}$  (Command mode selection),  $\text{F} \text{R} \text{Q}$  (Frequency setting mode selection 1).

Title	Function	Adjustment range	Default setting
$\text{C} \text{M} \text{D}$	Command mode selection	0: Terminal board 1: Panel 2:RS485 communication	0
$\text{F} \text{R} \text{Q}$	Frequency setting mode selection 1	1: VIA 2: VIB 3: Operation panel 4: RS485 communication 5: External contact up/down	1

\* See 5.3 for  $\text{C} \text{M} \text{D}$ ,  $\text{F} \text{R} \text{Q}$ .

### 3.1.1 How to start and stop

#### ■ Example of a $\text{C} \text{R} \text{O} \text{d}$ setting procedure

Key operated	LED display	Operation
	0.0	Displays the operation frequency (operation stopped). (When standard monitor display selection $F \ 1 \ 1Q=0$ [Operation frequency])
(MODE)	RUF	Displays the first basic parameter [Wizard function (RUF)].
( $\Delta$ ) ( $\nabla$ )	CROd	Press either the $\Delta$ or $\nabla$ key to select "CROd".
(ENT)	0	Press ENT key to display the parameter setting. (Default setting: 0).
( $\Delta$ )	1	Change the parameter to 1 (panel) by pressing the $\Delta$ key.
(ENT)	1 $\leftrightarrow$ CROd	Press the ENT key to save the changed parameter. CROd and the parameter set value are displayed alternately.

#### (1) Start and stop using the operation panel keys ( $\text{C} \text{R} \text{O} \text{d}=1$ )

Use the (RUN) and (STOP) keys on the operation panel to start and stop the motor.

(RUN) : Motor starts. (STOP) : Motor stops.

★ To switch between forward run and reverse run from the control panel, the parameter  $F \ r$  (forward/reverse run selection) needs to be set to 2 or 3.

#### (2) RUN/STOP by means of an external signal to the terminal board ( $\text{C} \text{R} \text{O} \text{d}=0$ ): Sink (Negative) logic

Use external signals to the inverter terminal board to start and stop the motor.

Short **F** and **CC** terminals: run forward

Open **F** and **CC** terminals: slow down and stop

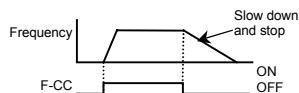

#### (3) Coast stop

The standard default setting is for slowdown stop. To make a coast stop, assign a "1(ST)" terminal function to an idle terminal using the programmable terminal function.





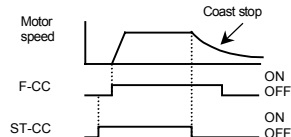

Change to  $F \ 1 \ 1Q=0$ .

For coast stop, open the ST-CC when stopping the motor in the state described at left. The monitor on the inverter at this time will display 0FF.



### 3.1.2 How to set the frequency



#### ■ Example of a $F \Delta \nabla d$ setting procedure

Key operated	LED display	Operation
	0.0	Displays the operation frequency (operation stopped). (When standard monitor display selection $F \Delta \nabla d = 0$ [Operation frequency])
	RUF	Displays the first basic parameter [Wizard function (RUF)].
 	$F \Delta \nabla d$	Press either the $\Delta$ key or $\nabla$ key to select " $F \Delta \nabla d$ ".
	!	Press ENT key to display the parameter setting. (Default setting: !).
	3	Change the parameter to 3 (Operation panel) by pressing the $\Delta$ key.
	$3 \leftrightarrow F \Delta \nabla d$	Press the ENT key to save the changed parameter. $F \Delta \nabla d$ and the parameter set value are displayed alternately.





\* Pressing the  key twice returns the display to standard monitor mode (displaying operation frequency).

#### (1) Setting the frequency using the operation panel ( $F \Delta \nabla d = 3$ )

Set the frequency with the operation panel..

 : Moves the frequency up     : Moves the frequency down

#### ■ Example of operating a run from the panel

Key operated	LED display	Operation
	0.0	Displays the operation frequency. (When standard monitor display selection $F \Delta \nabla d = 0$ [Operation frequency])
 	50.0	Set the operation frequency.
	$50.0 \leftrightarrow F \Delta$	Press the ENT key to save the operation frequency. $F \Delta$ and the frequency are displayed alternately.
 	60.0	Pressing the $\Delta$ key or the $\nabla$ key will change the operation frequency even during operation.



(2) Setting the frequency using the operation panel (FREQ=1 or 2)

■ Frequency setting

1) Setting the frequency using external potentiometer

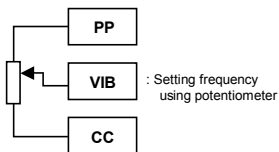

VIB : Setting frequency using potentiometer

\* The input terminal VIA can be used in the same way.  
 FREQ=1: VIA effective, FREQ=2: VIB effective  
 => For more details, see section 6.5.

★Potentiometer

Setting frequency using the potentiometer (1k-10kΩ, 1/4W)  
 => For more detailed information on adjustments, see section 6.5.

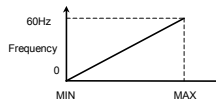

2) Setting the frequency using input voltage (0-10V)

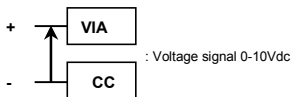

VIA : Voltage signal 0-10Vdc

\* The input terminal VIB can be used in the same way.  
 FREQ=1: VIA effective, FREQ=2: VIB effective  
 => For more details, see section 6.5.

Note: Be sure to turn the VIA (SW3) slide switch to the V (voltage) position.

★Voltage signal

Setting frequency using voltage signals (0-10V).  
 => For more detailed information on adjustments, see section 6.5.

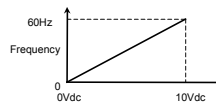

3) Setting the frequency using current input (4-20mA)

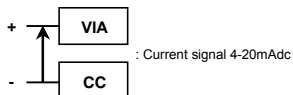

VIA : Current signal 4-20mA dc

\* Setting of parameters also allow 0-20mA dc.

Note: Be sure to turn the VIA (SW3) slide switch to the I (current) position.

★Current Signal

Current signal Setting frequency using current signals (4-20mA).  
 => For more detailed information on adjustments, see section 6.5.

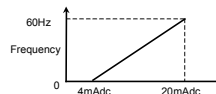

## 3.2 How to operate the VF-FS1

Overview of how to operate the inverter with simple examples.

### Ex.1

Remote mode selection,

Setting the operation frequency using the operation panel and running and stopping using the operation panel.

#### (1) Wiring

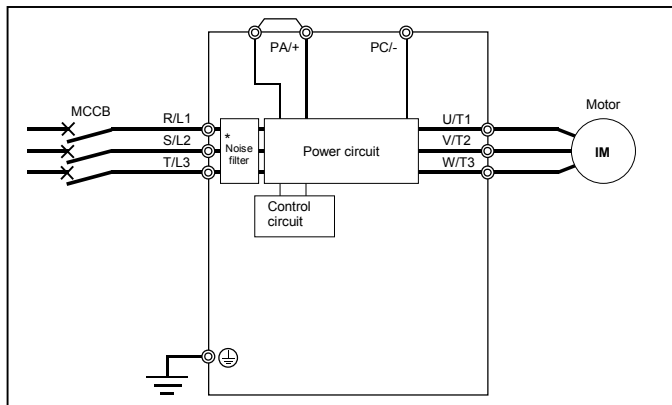

#### (2) Parameter setting

Title	Function	Setting value
$\overline{C} \overline{M} \overline{D}$	Command mode selection	1
$\overline{F} \overline{M} \overline{D}$	Frequency setting mode selection 1	3

#### (3) Operation

Run/stop: Press the  $\text{RUN}$  and  $\text{STOP}$  keys on the panel.

Frequency setting: Set with the  $\uparrow$  and  $\downarrow$  keys on the operation panel.

To store the set frequencies in memory, press the  $\text{ENT}$  key.

$\overline{F} \overline{L}$  and the set frequency will flash on and off alternately.

## Ex.2

Remote mode selection,  
Operation frequency setting, running and stopping using external signals.

## (1) Wiring

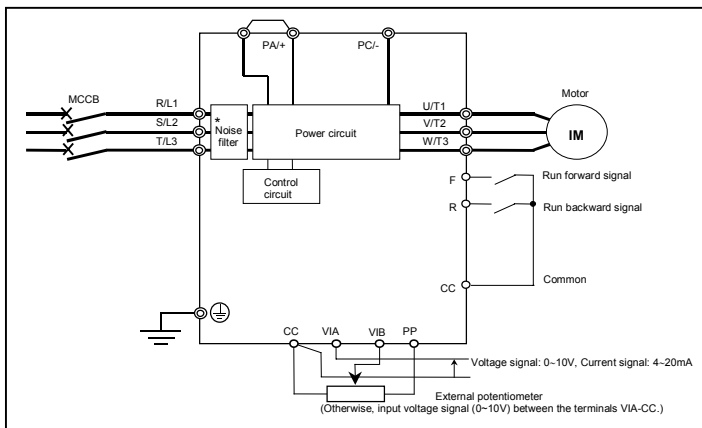

## (2) Parameter setting

Title	Function	Setting value
<b>C M d</b>	Command mode selection	0
<b>F M d</b>	Frequency setting mode selection 1	1or2

## (3) Operation

Run/stop: ON/OFF input to F-CC, R-CC. (Set SW4 to Sink logic)

Frequency setting: VIA and VIB: 0-10Vdc (External potentiometer)

VIA: Input 4-20mA

Use the VIA (SW3) slide switch to switch between voltage and current to the VIA terminal.

Voltage input: V side

Current input: I side

★Please turn off the lamp by pressing the  key when the LOC/REM key lamp is lit.

## 4. Basic VF-FS1 operations

The VF-FS1 has the following three monitor modes.

### Standard monitor mode

: The standard inverter mode. This mode is enabled when inverter power goes on.

This mode is for monitoring the output frequency and setting the frequency designated value. In it is also displayed information about status alarms during running and trips.

- Setting frequency designated values ⇒ See section 3.1.2
- Status alarm

If there is an error in the inverter, the alarm signal and the frequency will flash alternately in the LED display.

$\overline{I}$  : When a current flows at or higher than the overcurrent stall level.

$P$  : When a voltage is generated at or higher than the over voltage stall level.

$\overline{L}$  : When a load reaches 50% or higher of the overload trip value.

$H$  : When the temperature reaches the overheating protection alarm level.

### Setting monitor mode

: The mode for setting inverter parameters.

How to set parameters ⇒ See section 4.2.

### Status monitor mode

: The mode for monitoring all inverter status.

Allows monitoring of set frequencies, output current/voltage and terminal information.

For more on how to use the monitor ⇒ See section 8.1.

Pressing the key  will move the inverter through each of the modes.

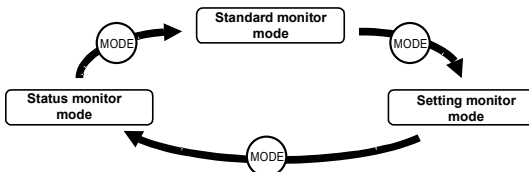

## 4.1 Flow of status monitor mode

Flow of monitor as following

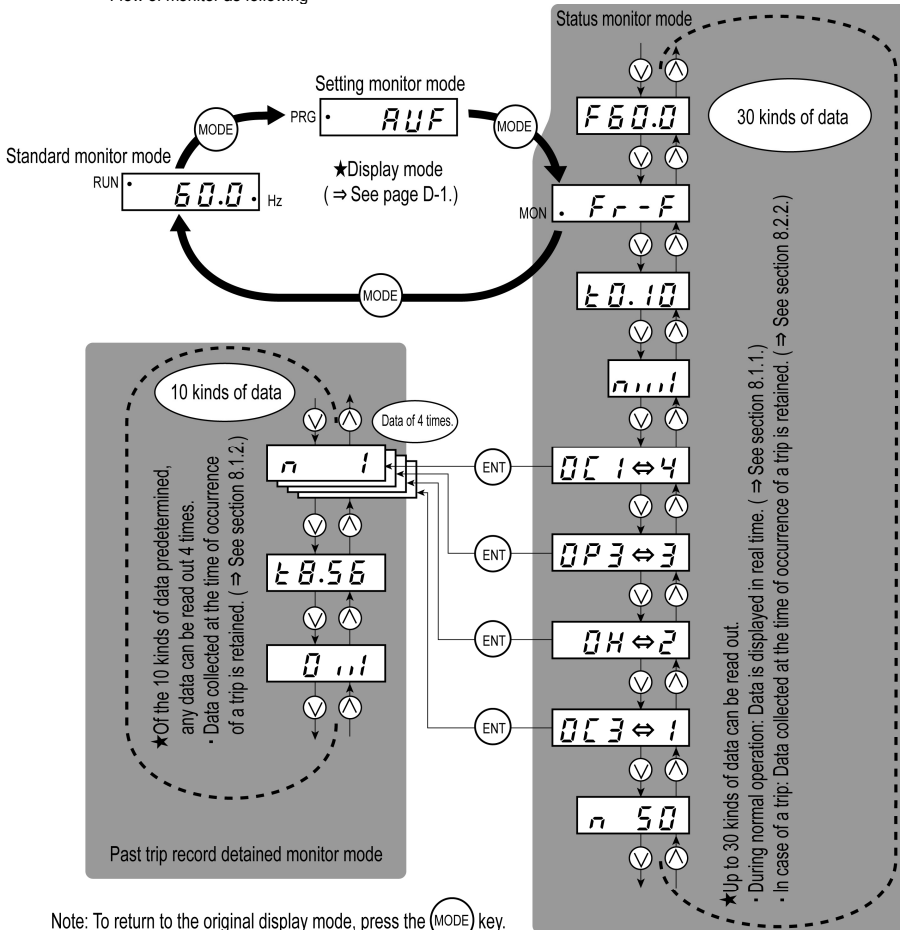

Note: To return to the original display mode, press the **MODE** key.

## 4.2 How to set parameters

The standard default parameters are programmed before the unit is shipped from the factory. Parameters can be divided into 5 major categories. Select the parameter to be changed or to be searched and retrieved.

- Basic parameters

 : The basic parameters that must be programmed before the first use. ⇒ See section 4.2.1.
- Extended parameters

 : The parameters for detailed and special setting. ⇒ See section 4.2.2.
- User parameters

 : Indicates parameters that are different from the standard default setting parameters. Use them to check after setting and to change setting. (Parameter title: *U r U*). ⇒ See section 4.2.3.
   
(automatic edit function)
- Wizard function

 : The wizard function refers to the special function of calling up ten frequently used parameters. You can set up the inverter easily by simply setting the parameters in one after another. (Parameter name: *R U F*). ⇒ See section 4.2.4.
- History parameter

 : This parameter has the function of displaying, in reverse chronological order, the five parameters that were changed last. This function comes in very handy when you adjust the inverter repeatedly using the same parameter. (Parameter name: *R U H*). ⇒ See section 4.2.5.

\* Adjustment range of parameters

*H I*: An attempt has been made to assign a value that is higher than the programmable range. Or, as a result of changing other parameters, the programmed value of the parameter that is now selected exceeds the upper limit.

*L O*: An attempt has been made to assign a value that is lower than the programmable range. Or, as a result of changing other parameters, the programmed value of the parameter that is now selected exceeds the lower limit.

If the above alarm is flashing on and off, no setting can be done of values that are equal to or greater than *H I* or equal to or lower than *L O*.

## 4.2.1 How to set the basic parameters

All of the basic parameters can be set by the same step procedures.

[Steps in key entry for basic parameters]

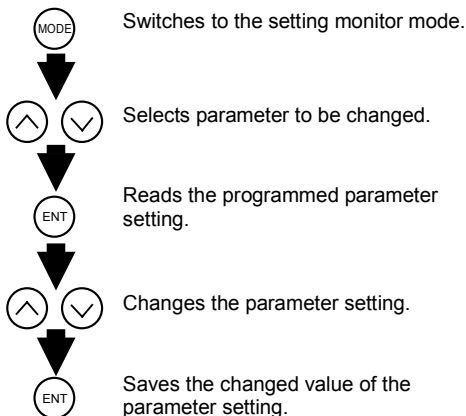

- \* Parameters were factory-set by default before shipment.
- \* Select the parameter to be changed from "Table of parameters".
- \* If there is something that you do not understand during the operation, press the MODE key to return to the  $0.0$  indication.  
⇒ See section 11.2 for basic parameters.

### ■ Example of setting procedure (Changing the maximum frequency from 80Hz to 60Hz).

Key operated	LED display	Operation
	$0.0$	Displays the operation frequency (operation stopped). (When standard monitor display selection $F \uparrow$ ; $0=0$ [Operation frequency])
	$RU F$	The first basic parameter "RU F" (Wizard function) is displayed.
	$F H$	Press either the $\Delta$ or $\nabla$ key to select "FH".
	$80.0$	Pressing the ENT key reads the maximum frequency.
	$60.0$	Press the $\nabla$ key to change the maximum frequency to 60Hz.
	$60.0 \rightarrow FH$	Press the ENT key to save the maximum frequency. $FH$ and the frequency are displayed alternately.
After this,	→Displays the same programmed parameter.	→Switches to the display in the status monitor mode.
		→Displays names of other parameters.

## 4.2.2 How to set extended parameters

The VF-FS1 has extended parameters to allow you to make full use of its functions.  
All extended parameters are expressed with  $F$  and three digits.

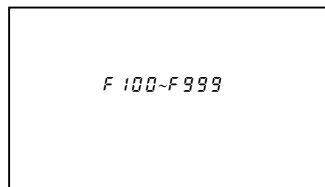
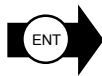
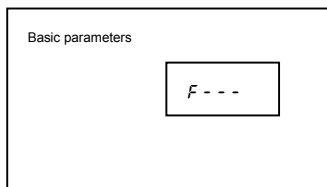

Press the MODE key once and use the  $\Delta$  /  $\nabla$  key to select  $F - - -$  from the basic parameters.

Press the  $\Delta$  key or the  $\nabla$  key to change the set value. Pressing the ENT key allows the reading of parameter setting.

4

[Steps in key entry for extended parameters]

⇒ See section 11.3 for extended parameters.

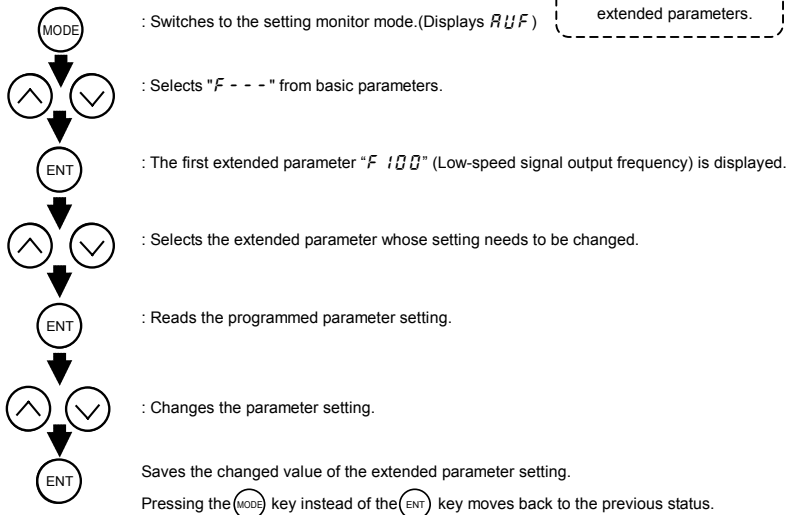









## ■ Example of parameter setting

Steps in setting are as follows

(Example of Auto-restart control selection  $F 30 1$  from 0 to 1.)

Key operated	LED display	Operation
	0.0	Displays the operation frequency (operation stopped). (When standard monitor display selection $F 7 10=0$ [Operation frequency])
	RUF	The first basic parameter "RUF" (Wizard function) is displayed.
	F - - -	Press either the $\Delta$ or the $\nabla$ to change to the parameter group $F - - -$ .
	F 100	Press the ENT key to display the first extended parameter $F 100$ .
	F 30 1	Press the $\Delta$ key to change to the auto-restart control selection $F 30 1$ .
	0	Pressing the ENT key allows the reading of parameter setting.
	1	Press the $\Delta$ key to change the auto-restart control selection from 0 to 1.
	1 $\rightarrow$ F 30 1	Pressing the ENT key alternately flashes on and off the parameter and changed value and allows the save of those values.

If there is anything you do not understand during this operation, press the MODE key several times to start over from the step of RUF display.

### 4.2.3 Search and resetting of changed parameters ( $G r . U$ )

Automatically searches for only those parameters that are programmed with values different from the standard default setting and displays them in the user parameter group  $G r . U$ . Parameter setting can also be changed within this group.

















#### Notes on operation

- If you reset a parameter to its factory default, the parameter will no longer appear in  $G r . U$ .
- $F n, F 4 70 - F 4 73$  are not appeared, if the value of these parameters are changed.
- $F n5L, F 109, F 880$  are appeared after setting  $t y P$  to 3. (Refer to Section 5.5)

## ■ How to search and reprogram parameters

The operations of search and resetting of parameters are as follows.

Key operated	LED display	Operation
	0.0	Displays the operation frequency (operation stopped). (When standard monitor display selection $F 7 10=0$ [Operation frequency])
	RUF	The first basic parameter "RUF" (Wizard function) is displayed.

Key operated	LED display	Operation
 	$\bar{U}r.U$	Press $\Delta$ or $\nabla$ key to select $\bar{U}r.U$ .
	$U - - -$	Press the ENT key to enable the user parameter automatic edit function.
 OR  	$U - - F$ ( $\bar{U} - - r$ ) $\downarrow$ $R\bar{C}\bar{C}$	Searches for parameters that are different in value from the standard default setting and displays those parameters. Press the ENT key or the $\Delta$ key to change the parameter displayed. (Pressing the $\nabla$ key moves the search in the reverse direction).
	$B.D$	Press the ENT key to display the set value.
 	$S.D$	Press the $\Delta$ key and $\nabla$ key to change set value.
	$S.D \leftrightarrow R\bar{C}\bar{C}$	Press the ENT key to save the changed value. The parameter name and the programmed value will flash on and off alternately. After the change has been saved, " $U - - -$ " is displayed.
 (  )	$U - - F$ ( $\bar{U} - - r$ )	Use the same steps as those given above to display parameters that you want to search for or change setting with the $\Delta$ key and $\nabla$ key.
 (  )	$\bar{U}r.U$	When $\bar{U}r.U$ appears again, the search is ended.
 	$\bar{U}r.U$ $\downarrow$ $F\bar{r}-F$ $\downarrow$ $0.0$	A search can be canceled by pressing the MODE key. Press the MODE key once while the search is underway to return to the display of parameter setting mode. After that you can press the MODE key to return to the status monitor mode or the standard monitor mode (display of operation frequency).

If there is anything you do not understand during this operation, press the  key several times to start over from the step of  $R\bar{U}F$  display.

## 4.2.4 Setting a parameter, using the wizard function ( $R\bar{U}F$ )

Wizard function ( $R\bar{U}F$ ):

The wizard function refers to the special function of calling up ten frequently used parameters. You can set up the inverter easily by simply setting the parameters in one after another.







Notes on operation

- If there is anything you do not understand during this operation, press the  key several times to start over from the step of  $R\bar{U}F$  display.  
 $HE\bar{R}d$  or  $E\bar{n}d$  is affixed respectively to the first or last parameter.

[Parameter setting]

Title	Function	Adjustment range	Default setting
<i>RUF</i>	Wizard function	The wizard function refers to the special function of calling up ten frequently used parameters.	-

#### ■ How to use the wizard function

Key operated	LED display	Operation
	<i>0.0</i>	Displays the operation frequency (operation stopped). (When standard monitor display selection <i>F 7 i Q = Q</i> [Operation frequency])
	<i>RUF</i>	The first basic parameter " <i>RUF</i> " (Wizard function) is displayed.
	<i>RU 1</i>	Press the ENT key to confirm your choice. The first parameter in the purpose-specific wizard parameter group is displayed. (See Table below)
 (  )	****	After moving to the purpose-specific wizard parameter group, change the setting of each parameter by pressing the $\Delta$ or $\nabla$ key and the ENT key.
	<i>End</i>	<i>End</i> is dialyzed on completion of the setting of the wizard parameter group.
  	Parameter display ↓ <i>RUF</i> ↓ <i>F r - F</i> ↓ <i>0.0</i>	Press the MODE key to exit the wizard parameter group. By pressing the MODE key, you can return to the default monitoring mode (display of operation frequency).

#### ■ How Parameters of Quick setting wizard

Title	Function
<i>RU 1</i>	Automatic acceleration/deceleration
<i>ACC</i>	Acceleration time 1
<i>dEC</i>	Deceleration time 1
<i>LL</i>	Lower limit frequency
<i>UL</i>	Upper limit frequency
<i>tHr</i>	Motor thermal protection
<i>F<math>\eta</math></i>	Meter adjustment
<i>P<math>\epsilon</math></i>	V/F control mode selection
<i>u<math>\omega</math></i>	Base frequency 1
<i>u<math>\omega</math>u</i>	Base frequency voltage 1

## 4.2.5 Searching for a history of changes, using the history function (RHH)

History function (RHH):

Automatically searches for 5 latest parameters that are programmed with values different from the standard default setting and displays them in the RHH. Parameter setting can also be changed within this group RHH.

Notes on operation

- If no history information is stored, this parameter is skipped and the next parameter "RUI" is displayed.
- HERRd and End are added respectively to the first and last parameters in a history of changes.

### ■ How to use the history function

Key operated	LED display	Operation
	0.0	Displays the operation frequency (operation stopped). (When standard monitor display selection F7ID=0 [Operation frequency])
(MODE)	RUF	The first basic parameter "RUF" (Wizard function) is displayed.
(△) (▽)	RHH	Select the History function (RHH) by pressing the △ or ▽ key.
(ENT)	ACC	The parameter that was set or changed last is displayed.
(ENT)	8.0	Press the ENT key to display the set value.
(△) (▽)	5.0	Press the △ key and ▽ key to change set value.
(ENT)	5.0 ↔ ACC	Press the ENT key to save the changed value. The parameter name and the programmed value will flash on and off alternately.
(△) ((▽))	****	Use the same steps as those given above to display parameters that you want to search for or change setting with the △ key and ▽ key.
(△) ((▽))	HERRd (End)	HERRd: First historic record End: Last historic record
(MODE) (MODE) (MODE)	Parameter display ↓ RUF ↓ F r - F ↓ 0.0	Press the MODE key to return to the parameter setting mode "RUF." After that you can press the MODE key to return to the status monitor mode or the standard monitor mode (display of operation frequency).

Note: Parameter F700 (Prohibition of change of parameter settings) is not displayed in this "RHH".

## 4.2.6 Parameters that cannot be changed while running

For safety reasons, the following parameters have been set up so that they cannot be reprogrammed while the inverter is running. Stop operation ("0.0" or "0FF" is displayed) before changing parameter settings.

### [Basic parameters]

<i>RU1</i>	: Automatic acceleration/deceleration	
<i>RU4</i>	: Parameter setting macro function	
<i>CNDd</i>	: Command mode selection	} Set <i>F736</i> , and they can be changed while the inverter is running.
<i>FN0d</i>	: Frequency setting mode selection 1	
<i>tYP</i>	: Default setting	
<i>FH</i>	: Maximum frequency	
<i>uL</i>	: Base frequency 1	
<i>uLv</i>	: Base frequency voltage1	
<i>Pt</i>	: V/F control mode selection 1	

### [Extended parameters]

<i>F100-F118</i>	: Input terminal selection parameters
<i>F130-F139</i>	: Output terminal selection parameters
<i>F170</i>	: Base frequency 2
<i>F171</i>	: Base frequency voltage 2
<i>F301-F311</i>	: Protection parameters
<i>F316</i>	: Carrier frequency control mode selection
<i>F400</i>	: Auto-tuning
<i>F415-F419</i>	: Motor constant parameters
<i>F480-F496</i>	: Motor control parameters
<i>F601</i>	: Stall prevention level 1
<i>F603</i>	: Emergency stop selection
<i>F605</i>	: Output phase failure detection mode selection
<i>F608</i>	: Input phase failure detection mode selection
<i>F613</i>	: Detection of output short-circuit during start-up selection
<i>F626</i>	: Over-voltage stall protection level
<i>F627</i>	: Under voltage trip/alarm selection
<i>F732</i>	: Prohibition of panel local/remote operation (  key)
<i>F910-F912</i>	: PM motor parameters

The setting of any parameter other than the above can be changed even during operation.

Keep in mind, however, that when the parameter *F700* (prohibition of change of parameter settings) is set to 1 (prohibited), no parameters can be set or changed.

## 4.2.7 Returning all parameters to standard default setting







Setting the standard default setting parameter  $\text{tYP}=3$ , all parameters can be returned to the those factory default settings.

⇒ For more details on the standard default setting parameter  $\text{tYP}$ , see section 5.5.

### Notes on operation

- We recommend that before this operation you write down on paper the values of those parameters, because when setting  $\text{tYP}=3$ , all parameters with changed values will be returned to standard factory default setting.
- Note that  $F\bar{n}$ ,  $F\bar{n}5L$ ,  $F109$ ,  $F470-F473$  and  $F880$  will not be reset to their factory default settings.

### ■ Steps for returning all parameters to standard default setting

Key operated	LED display	Operation
	0.0	Displays the operation frequency (perform during operation stopped).
	RUF	The first basic parameter "RUF" (Wizard function) is displayed.
 	tYP	Press the $\Delta$ key or the $\nabla$ key to change to tYP.
	3 0	Pressing the ENT key displays the programmed parameters. (tYP will always display "0(zero)" on the right, the previous setting on the left.)
 	3 3	Press the $\Delta$ key or the $\nabla$ key to change the set value. To return to standard factory default setting, change to "3".
	in it	Pressing the ENT key displays "in it" while returning all parameters to factory default setting.
	0.0	The monitor returns to the display of setup parameters.

If there is anything you do not understand during this operation, press the  key several times to start over from the step of RUF display.

## 4.2.8 How to save/load the user setting parameters

The current settings of all parameters can be stored (saved) in memory at a time by setting the standard setting mode selection parameter  $\text{tYP}$  to 7. Also, all parameter settings stored in memory can be restored (loaded) by setting parameter  $\text{tYP}$  to 8. This means that you can use this parameter ( $\text{tYP}=7$  and 8) as the parameter for your own initial settings (default settings).

## 5. Basic parameters

Before you operate the inverter, the parameters that you must first program are the basic parameters.

### 5.1 Setting acceleration/deceleration time

**$\overline{RUL}$**  : Automatic acceleration/deceleration

**$\overline{RCL}$**  : Acceleration time 1

**$\overline{DEL}$**  : Deceleration time 1

- Function

- 1) For acceleration time 1  $\overline{RCL}$  programs the time that it takes for the inverter output frequency to go from 0Hz to maximum frequency  $\overline{FH}$ .
- 2) For deceleration time 1  $\overline{DEL}$  programs the time that it takes for the inverter output frequency to get from maximum frequency  $\overline{FH}$  to 0Hz.

5

#### 5.1.1 Automatic acceleration/deceleration

This automatically adjusts acceleration and deceleration time in line with load size.

**$\overline{RUL}$**  = 1

\* Adjusts the acceleration/deceleration time automatically within the range of 1/8 to 8 times as long as the time set with the  $\overline{RCL}$  or  $\overline{DEL}$ , depending on the current rating of the inverter.

**$\overline{RUL}$**  = 2

\* Automatically adjusts speed during acceleration only. During deceleration, speed is not adjusted automatically but reduced at the rate set with  $\overline{DEL}$ .

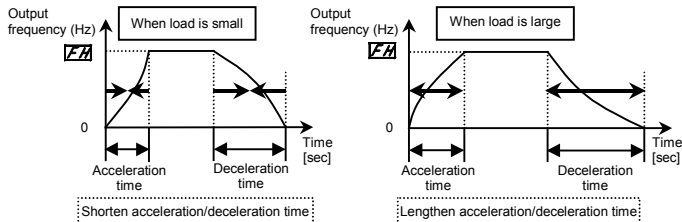





Set  $\overline{RUL}$  (automatic acceleration/deceleration) to 1 or 2.

[Parameter setting]

Title	Function	Adjustment range	Default setting
<i>RU 1</i>	Automatic acceleration/deceleration	0: Disabled (manual) 1: Automatic 2: Automatic (only at acceleration)	0

- ★ When automatically setting acceleration/deceleration time, always change the acceleration/deceleration time so that it conforms to the load. The acceleration/deceleration time changes constantly with load fluctuations. For inverters that requires a fixed acceleration/deceleration time, use the manual settings (*RE L*, *dEL*).
- ★ Setting acceleration/deceleration time (*RE L*, *dEL*) in conformance with mean load allows optimum setting that conforms to further changes in load.
- ★ Use this parameter after actually connecting the motor.
- ★ When the inverter is used with a load that fluctuates considerably, it may fail to adjust the acceleration or deceleration time in time, and therefore may be tripped.

### ■ Methods of setting automatic acceleration/deceleration

Key operated	LED display	Operation
	<i>0.0</i>	Displays the operation frequency. (When standard monitor display selection <i>F 7 10</i> is set to <i>0</i> [Operation frequency])
	<i>RU F</i>	The first basic parameter " <i>RU F</i> " (Wizard function) is displayed.
	<i>RU 1</i>	Press the $\Delta$ key to change the parameter to <i>RU 1</i> .
	<i>0</i>	Pressing the ENT key allows the reading of parameter setting.
	<i>1</i>	Press the $\Delta$ key to change the parameter to <i>1</i> or <i>2</i> .
	<i>1</i> $\leftrightarrow$ <i>RU 1</i>	Press the ENT key to save the changed parameter. <i>RU 1</i> and the parameter are displayed alternately.

## 5.1.2 Manually setting acceleration/deceleration time

Set acceleration time from 0 (Hz) operation frequency to maximum frequency *FH* and deceleration time as the time when operation frequency goes from maximum frequency *FH* to 0 (Hz).

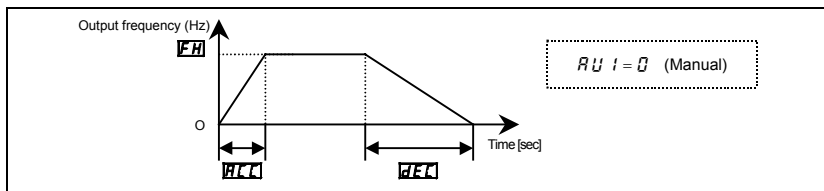



[Parameter setting]

Title	Function	Adjustment range	Default setting
$P\checkmark\checkmark$	Acceleration time 1	0.0-3200 sec.	According to model (⇒ See page K-14)
$dE\checkmark\checkmark$	Deceleration time 1	0.0-3200 sec.	According to model (⇒ See page K-14)

Note: When the acceleration/deceleration time is set at 0.0 seconds, the inverter speed increases or reduces speed within 0.05 seconds.

- ★ If the programmed value is shorter than the optimum acceleration/deceleration time determined by load conditions, overcurrent stall or overvoltage stall function may make the acceleration/deceleration time longer than the programmed time. If an even shorter acceleration/deceleration time is programmed, there may be an overcurrent trip or overvoltage trip for inverter protection.

⇒ For further details, see section 13.1.

## 5.2 Specifying an operation mode, using parameters

### **R44**: Parameter setting macro function

- Function  
Automatically programs all parameters (parameters described below) related to the functions by selecting the inverter's operating method.  
The major functions can be programmed simply.

[Parameter setting]

Title	Function	Adjustment range	Default setting
R44	Parameter setting macro function	0: Disabled 1: Coast stop 2: 3-wire operation 3: External input UP/DOWN setting 4: 4-20mA current input operation	0:

Note: When this parameter is invoked after it has been set,  $\bar{0}$  is always displayed (on the right side).

The number on the left side refers to the number specified previously.

Example  $\bar{1} \bar{0}$

Automatically programmed functions and parameter set values

Relational parameter	Default setting value	1: Coast stop	2: 3-wire operation	3: External input UP/DOWN setting	4: 4-20mA current input operation
$\bar{C} \bar{N} \bar{0} \bar{d}$	0: Terminal board	0: Terminal board	0: Terminal board	0: Terminal board	0: Terminal board
$\bar{F} \bar{N} \bar{0} \bar{d}$	1: VIA	1: VIA	1: VIA	5: UP/DOWN from external contact	1: VIA
$\bar{F} \bar{1} \bar{1} \bar{0}$ (Always)	1: ST	0: Disabled	1: ST	1: ST	1: ST
$\bar{F} \bar{1} \bar{1} \bar{1}$ (F)	2:F	2:F	2:F	2:F	2:F
$\bar{F} \bar{1} \bar{1} \bar{2}$ (R)	3:R	1:ST	49:HD	41:UP	6:S1
$\bar{F} \bar{1} \bar{1} \bar{3}$ (RES)	10: RES	10: RES	10: RES	42:DOWN	10: RES
$\bar{F} \bar{2} \bar{0} \bar{1}$	0 (%)	-	-	-	20 (%)

⇒ See K-14 for input terminal functions.

Disabled ( $\bar{R} \bar{4} \bar{4} = \bar{0}$ )

The parameter does nothing. Even if set to  $\bar{0}$ ,  $\bar{R} \bar{4} \bar{4}$  will not return the setting you made to its factory default.

### Coast stop ( $R U 4 = 1$ )

Setting for coast stopping. In sink logic mode, closing the circuit between the R and CC terminals places the inverter in standby mode and opening the circuit places it in coast stop mode, because ST (standby signal) is assigned to the R terminal.

⇒ See section 3.1.1 (3) and 6.3.1 for details.

### 3-wire operation ( $R U 4 = 2$ )

Can be operated by a momentary push-button. HD (operation holding) is assigned to the terminal R. A self-holding of operations is made in the inverter by connecting the stop switch (b-contact) to the R terminal and connecting the running switch (a-contact) to the F terminal.

#### ★ Three-wire operation (one-touch operation)

You can carry out operation by simply pressing the ON/OFF button.

### Standard connection diagram- Forward run

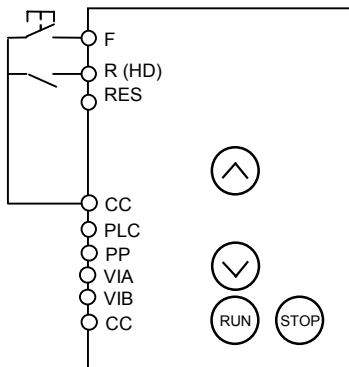

Selecting HD (operation holding) with the input terminal selection parameter

Select HD (operation holding) using the input terminal selection parameter, and turn HD on to get the inverter ready for operation or turn HD off to stop operation.

#### Parameter setting:

When parameter  $R U 4$  is set to 2, the following parameters are set automatically.

$F 1 1 0 : 1$  (ST)

$C 1 0 0 : 0$  (terminal board).

R terminal  $F 1 1 2 : 4 9$  (operation holding).

Note 1 : Even if each terminal is ON, any command entered through a terminal is ignored when power is turned on (to prevent the load from starting to move unexpectedly). Enable to turn the input terminal on at power on.

Note 2 : When HD is OFF, any attempt to turn on F is ignored.

Note 3 : Sending out a RUN signal during DC braking has no effect in stopping DC braking.

In the case of reverse operation, the 3 wires operation is also possible as well as forward operation by assigning "R (reverse function)" to the "RES" terminal.

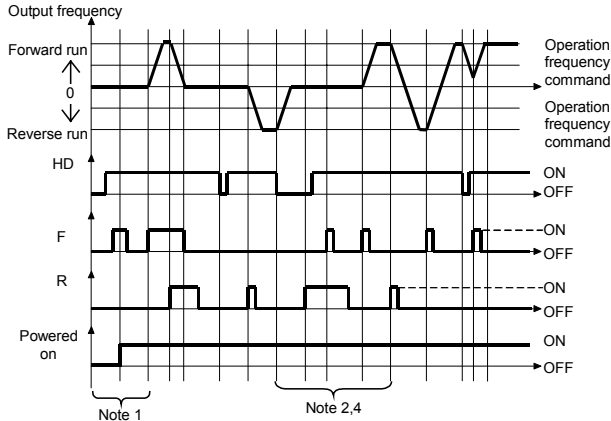

**Note 4 :**

When HD is OFF, any attempt to turn on F or R is ignored. When R is ON, you cannot start operation by turning on HD. Even when both R and HD are ON, you cannot start operation by turning on F. To start operation, turn off F and R temporarily, then turn them back on.

**External input UP/DOWN setting ( $R\bar{U}4=3$ )**

Allows setting of frequency with the input from an external contact. Can be applied to changes of frequencies from several locations.

In case of cancelling the frequency UP/DOWN, it is necessary to assign "CLR (frequency UP/DOWN cancellation from external contacts function)" to the "VIA" terminal separately.

⇒ See section 6.5.3 for details.

**4-20 mA current input( $R\bar{U}4=4$ )**

Used for setting frequencies with 4-20mA current input.

## 5.3 Selection of operation mode

### Local mode and Remote mode



**Local mode** : When Local mode selected by key, start and stop, and frequency setting are effective only by operation panel keys.  
The local lamp is lit while Local mode selected.

**Remote mode** : Start and stop, and frequency setting follow the selection of *CMD* (Command mode), or *FREQ* (Frequency setting mode).

### Setting mode – Switching of commands and references

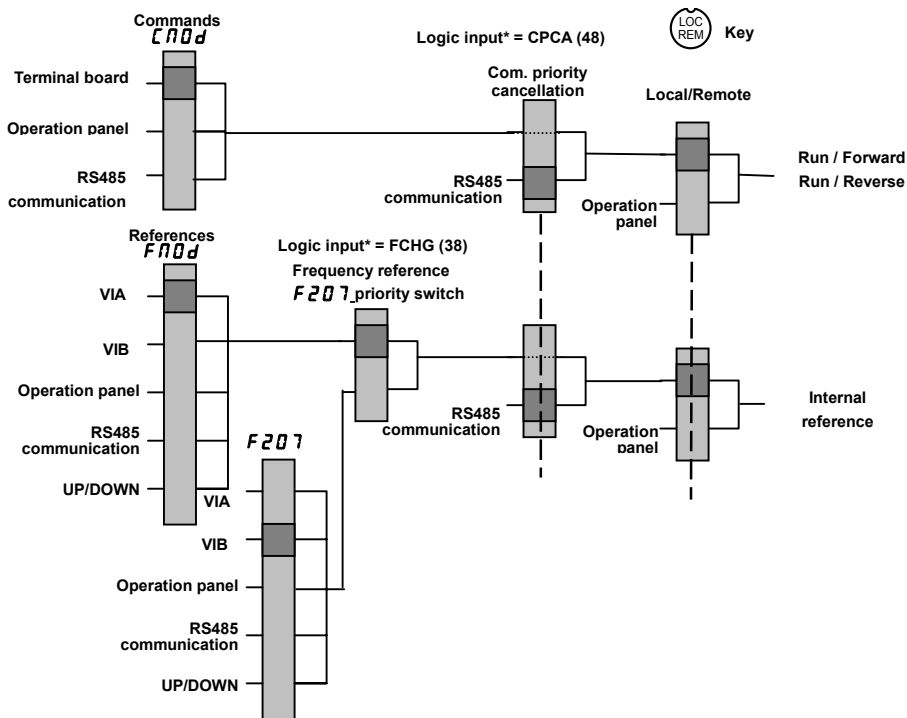

**Command**: Command mode selection

**Frequency**: Frequency setting mode selection 1

- Function

Remote mode selection, these parameters are used to specify which input device (operation panel, terminal board, RS485 communication) takes priority in entering an operation stop command or a frequency setting command, VIA, VIB, operation panel, RS485 communication device, external contact up/down).

At Local mode selection, the start/stop operation and frequency setting by operation panel is prior with no relation of **Command/Frequency** setting.

### <Command mode selection>

Title	Function	Adjustment range	Default setting
<b>Command</b>	Command mode selection	0: Terminal board 1: Operation panel 2: RS485 communication	0

#### Programmed value

**0**: Terminal board operation ON and OFF of an external signal Runs and stops operation.

**1**: Operation panel operation Press the **(RUN)** and **(STOP)** keys on the operation panel to start and stop.

**2**: Serial communication operation Run and stop through serial communication.

\* There are two types of function: the function that conforms to commands selected by **Command**, and the function that conforms only to commands from the terminal board.



⇒ See the table of input terminal function selection in Chapter 11.

\* When priority is given to commands from a linked computer or terminal board, they have priority over the setting of **Command**.

## &lt;Frequency setting mode selection&gt;

Title	Function	Adjustment range	Default setting
<i>F<sub>NO</sub>d</i>	Frequency setting mode selection 1	1: VIA 2: VIB 3: Operation panel 4: RS485 communication 5: UP/DOWN from external contact	1

[Programmed value]

- 1:  A frequency command is set by means of a signal from an external input device (VIA terminal: 0-10Vdc or 4-20mAdc).
- 2:  An external signal (VIB terminal: 0-10Vdc) is used to specify a frequency command.
- 3:  Press the  key or the  key on either the operation panel or the expansion panel (optional) to set frequency.
- 4:  Frequencies are set by commands from an external control unit.
- 5:  Terminals are used to specify an up/down frequency command.

- ★ No matter what value the command mode selection *C<sub>NO</sub>d* and the frequency setting mode selection *F<sub>NO</sub>d* are set to the control input terminal functions described below are always in operative state.
  - Reset terminal (default setting: RES, valid only for tripping)
  - Standby terminal (when programmed by programmable input terminal functions).
  - External input tripping stop terminal command (when so set using the programmable input terminal function)
- ★ To make changes in the command mode selection *C<sub>NO</sub>d* and the frequency setting mode selection 1 *F<sub>NO</sub>d*, first stop the inverter temporarily.

## ■ Preset-speed operation

*C<sub>NO</sub>d*: Set to 0 (Terminal board).*F<sub>NO</sub>d*: Valid in all setting values.

## 5.4 Meter setting and adjustment

**FN5L**: Meter selection

**FN**: Meter adjustment

- Function

The signal output from the FM terminal is an analog voltage signal.

For the meter, use either a full-scale 0-1mAdc ammeter or full-scale 0-7.5Vdc (or 10Vdc)-1mA voltmeter.

Switching to 0-20mAdc (4-20mAdc) output current can be made by turning the FM (SW2) slide switch to the I position. When switching to 4-20mAdc current input, make adjustments using **F59** (analog output gradient) and **F592** (analog output bias).

[Parameter setting]

Title	Function	Adjustment range	Supposition output at $FN5L=17$	Default setting
<b>FN5L</b>	Meter selection	0: Output frequency 1: Output current 2: Set frequency 3: DC voltage 4: Output voltage command value 5: Input power 6: Output power 7: Torque 8: Torque current 9: Motor cumulative load factor 10: Inverter cumulative load factor 11: - (Do not select) 12: Frequency setting value (after PID) 13: VIA Input value 14: VIB Input value 15: Fixed output 1 (Output current: 100%) 16: Fixed output 2 (Output current: 50%) 17: Fixed output 3 (Supposition output at $FN5L=17$ ) 18: RS485 communication data 19: For adjustments ( $FN$ set value is displayed.)	Maximum frequency ( $FH$ ) 1.5 times of rated current Maximum frequency ( $FH$ ) 1.5 times of rated voltage 1.5 times of rated voltage 1.85 times of rated power 1.85 times of rated power 2.5 times of rated torque 2.5 times of rated torque Rated load factor Rated load factor - Maximum frequency ( $FH$ ) Maximum input value Maximum input value - - - FA51=1000 -	0
<b>FN</b>	Meter adjustment	-	-	-



■ Resolution

All FM terminals have a maximum of 1/1000.

■ Example of 4-20mA output adjustment ⇒ For details, see section 6.19.1.

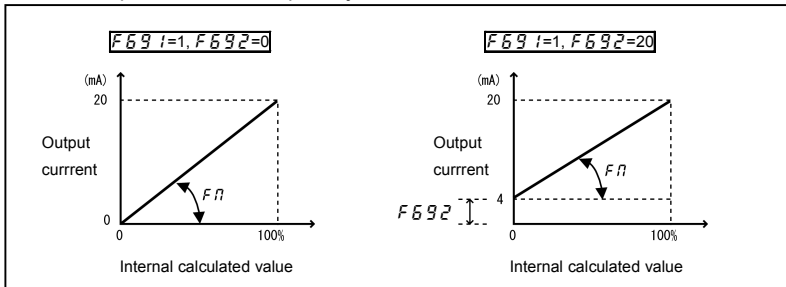

Note 1: When using the FM terminal for current output, be sure that the external load resistance is less than  $750\Omega$ .

Note 2: Note that, if  $F75L$  is set to 7 (torque), data will be updated at intervals of more than 40 ms.

■ Adjustment scale with parameter  $F7$  (Meter adjustment)

Connect meters as shown below.

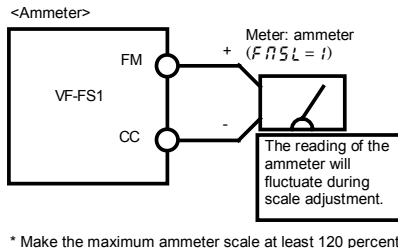
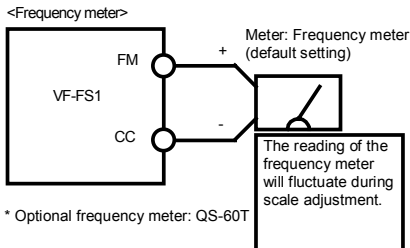

## ■ Example of how to adjustment the FM terminal frequency meter

\* Use the meter's adjustment screw to pre-adjust zero-point.

Key operated	LED display	Operation
-	50.0	Displays the operation frequency. (When standard monitor display selection $F710$ is set to 0 [Operation frequency])
(MODE)	RUF	The first basic parameter "RUF" (Wizard function) is displayed.
( $\Delta$ ) ( $\nabla$ )	$F\eta$	Press either the $\Delta$ or the $\nabla$ key to select " $F\eta$ ".
(ENT)	50.0	Press the ENT key to display the operation frequency
( $\Delta$ ) ( $\nabla$ )	50.0	Press either the $\Delta$ key or the $\nabla$ key to adjust the meter. The meter reading will change at this time but be careful because there will be no change in the inverter's digital LED (monitor) indication.
(ENT)	50.0 $\Leftrightarrow$ $F\eta$	The adjustment is complete. $F\eta$ and the frequency are displayed alternately.
(MODE) + (MODE)	50.0	The display returns to its original indications. (When standard monitor display selection $F710$ is set to 0 [Operation frequency])



[Hint]  
It's easier to make the adjustment if you push and hold for several seconds.

## ■ Adjusting the meter in inverter stop state

- Adjustment of output current ( $F\eta5L = 1$ )

If, when adjusting the meter for output current, there are large fluctuations in data during adjustment, making adjustment difficult, the meter can be adjusted in inverter stop state.

When setting  $F\eta5L$  to 15 for fixed output 1 (100% output current), a signal of absolute values will be output (inverter's rated current = 100%). In this state, adjust the meter with the  $F\eta$  (Meter adjustment) parameter.

Similarly, if you set  $F\eta5L$  to 16 for fixed output 2 (output current at 50%), a signal that is sent out when half the inverter's rated current is flowing will be output through the FM terminal.

After meter adjustment is ended, set  $F\eta5L$  to 1 (output current).

- Adjustment of other items ( $F\eta5L = 0, 2$  to 14, 18)

If parameter  $F\eta5L$  is set to 17: Fixed output 3 (Other than the output current: 100%), a signal that is sent out when  $F\eta5L$  is set to 0, 2 to 14, 18(100%) will be output through the FM terminal.

100% standard value for each item is the following:

$F\eta5L = 0, 2, 12$	: Maximum frequency ( $FH$ )
$F\eta5L = 3, 4$	: 1.5 times of rated voltage
$F\eta5L = 5, 6$	: 1.85 times of rated power
$F\eta5L = 7, 8$	: 2.5 times of rated torque
$F\eta5L = 9, 10$	: Rated load factor
$F\eta5L = 13, 14$	: Maximum input value
$F\eta5L = 18$	: FA51=1000

## 5.5 Standard default setting

### $\text{tYP}$ : Default setting

- Function  
Allows setting of all parameters to the standard default setting, etc. at one time.  
Note that  $RU\bar{F}$ ,  $RU\bar{H}$ ,  $F\bar{N}$ ,  $F\bar{N}5L$ ,  $F109$ ,  $F470 \sim F473$  and  $F880$  will not be reset to their factory default settings.

Title	Function	Adjustment range	Default setting
$\text{tYP}$	Default setting	0: - 1: 50Hz default setting 2: 60Hz default setting 3: Standard default setting (Initialization) 4: Trip record clear 5: Cumulative operation time clear 6: Initialization of type information 7: Save user-defined parameters 8: Call user-defined parameters 9: Cumulative fan operation time record clear	0

★ This function will be displayed as 0 during reading on the right. This previous setting is displayed.  
Example:  $\text{tYP} = 0$

★  $\text{tYP}$  cannot be set during the inverter operating. Always stop the inverter first and then program.

### Programmed value

#### 50Hz default setting ( $\text{tYP} = 1$ )

Setting  $\text{tYP}$  at 1 causes all the following parameters to be set for operation using a base frequency of 50 Hz. (This does not change the setting of any other parameters.)

Parameter  $F\bar{H}$ ,  $U\bar{L}$ ,  $U\bar{L}$ ,  $F170$ ,  $F204$ ,  $F213$ ,  $F814$ : 50Hz

Parameter  $F417$ : According to model

⇒ See page K-14.

#### 50Hz default setting ( $\text{tYP} = 2$ )

Setting  $\text{tYP}$  at 2 causes all the following parameters to be set for operation using a base frequency of 60 Hz. (This does not change the setting of any other parameters.)

Parameter  $F\bar{H}$ ,  $U\bar{L}$ ,  $U\bar{L}$ ,  $F170$ ,  $F204$ ,  $F213$ ,  $F814$ : 60Hz

Parameter  $F417$ : According to model

⇒ See page K-14.

Default setting ( $t Y P = 3$ )

Setting  $t Y P$  to  $3$  will return all parameters to the standard values that were programmed at the factory.  
⇒ See section 4.2.7.

- ★ When  $3$  is programmed,  $\overline{In It}$  will be displayed for a short time after setting and will then be erased and displayed the original indication  $U.U$ . Trip history data will be cleared at this time.

Trip clear ( $t Y P = 4$ )

Setting  $t Y P$  to  $4$  initializes the past four sets of recorded error history data.

- ★ The parameter does not change.

Cumulative operation time clear ( $t Y P = 5$ )

Setting  $t Y P$  to  $5$  resets the cumulative operation time to the initial value (zero).

Cumulative operation time clear ( $t Y P = 6$ )

Setting  $t Y P$  to  $6$  clears the trips when an  $E t Y P$  format error occurs. But if the  $E t Y P$  displayed, call us.

Save user setting parameters ( $t Y P = 7$ )

Setting  $t Y P$  to  $7$  saves the current settings of all parameters.  
⇒ See section 4.2.8.

Load user setting parameters ( $t Y P = 8$ )

Setting  $t Y P$  to  $8$  loads parameter settings to (calls up) those saved by setting  $t Y P$  to  $7$ .  
⇒ See section 4.2.8.  
★ By setting  $t Y P$  to  $7$  or  $8$ , you can use parameters as your own default parameters.

Cumulative fan operation time record clear ( $t Y P = 9$ )

Setting  $t Y P$  to  $9$  resets the cumulative operation time to the initial value (zero).  
Set this parameter when replacing the cooling fan, and so on.

## 5.6 Forward/reverse run selection (Operation panel operation)

**$F_r$** : Forward/reverse run selection (Operation panel operation)

- Function

Program the direction of rotation of the motor when the running and stopping are made using the **(RUN)** key and **(STOP)** key on the operation panel.

Valid when  $\mathcal{L} \mathcal{R} \mathcal{D}$  (command mode) is set to  $\mathcal{!}$  (operation panel).

### Parameter setting

Title	Function	Adjustment range	Default setting
$F_r$	Forward/reverse run selection (Operation panel operation)	0: Forward run 1: Reverse run 2: Forward run (F/R switching possible) 3: Reverse run (F/R switching possible)	0

- ★ When  $F_r$  is set to  $\mathcal{2}$  or  $\mathcal{3}$  and an operating status is displayed, pressing the **(^)** key with the **(ENT)** key held down changes the direction of rotation from reverse to forward after displaying the message " $F_r - F$ ." Pressing the **(v)** key again with the **(ENT)** key held down changes the direction of rotation from forward to reverse after displaying the message " $F_r - r$ ."
- ★ Check the direction of rotation on the status monitor.  
⇒ For monitoring, see section 8.1  
 $F_r - F$ : Forward run  
 $F_r - r$ : Reverse run
- ★ When the F and R terminals are used for switching between forward and reverse rotation from the terminal board, the  $F_r$  forward/reverse run selection parameter is rendered invalid.  
Short across the F-CC terminals: forward rotation  
Short across the R-CC terminals: reverse rotation.
- ★ The inverter was factory-configured by default so that shorting terminals F-CC and terminals R-CC simultaneously would cause the motor to slow down to a stop.  
Using the parameter  $F \mathcal{!} \mathcal{D} \mathcal{5}$ , however, you can select between forward run and reverse run.
- ★ This function is valid only when  $\mathcal{L} \mathcal{R} \mathcal{D}$  is set to  $\mathcal{!}$  (operation panel).

## 5.7 Maximum frequency

**$FH$** : Maximum frequency

- Function
  - 1) Programs the range of frequencies output by the inverter (maximum output values).
  - 2) This frequency is used as the reference for acceleration/deceleration time.

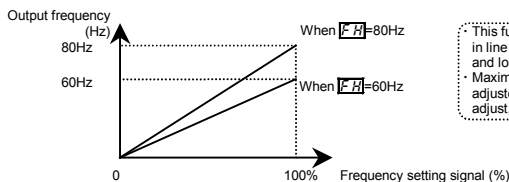

This function determines the value in line with the ratings of the motor and load.

- Maximum frequency cannot be adjusted during operation. To adjust, first stop the inverter.

★ If  $FH$  is increased, adjust the upper limit frequency  $UL$  as necessary.

[Parameter setting]

Title	Function	Adjustment range	Default setting
$FH$	Maximum frequency	30.0-200.0 (Hz)	80.0

## 5.8 Upper limit and lower limit frequencies

**$UL$** : Upper limit frequency

**$LL$** : Lower limit frequency

- Function
 

Programs the lower limit frequency that determines the lower limit of the output frequency and the upper limit frequency that determines the upper limit of that frequency.

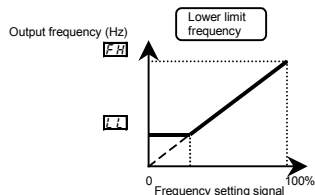
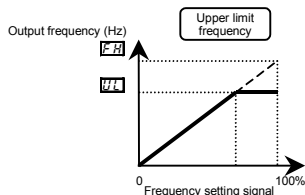

[Parameter setting]

Title	Function	Adjustment range	Default setting
$\omega L$	Upper limit frequency	0.5 - $F_H$ (Hz)	50.0 (WP type) 60.0 (WN type)
$L L$	Lower limit frequency	0.0 - $\omega L$ (Hz)	0.0

## 5.9 Base frequency

$\omega L$ : Base frequency 1

$\omega L U$ : Base frequency voltage 1

- Function  
Sets the base frequency and the base frequency voltage in conformance with load specifications or the Base frequency.

Note: This is an important parameter that determines the constant torque control area.

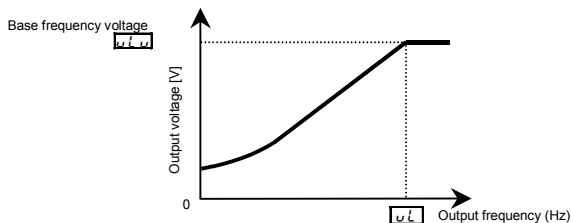

Title	Function	Adjustment range	Default setting
$\omega L$	Base frequency 1	25.0-200.0 (Hz)	50.0 (WP type) 60.0 (WN type)
$\omega L U$	Base frequency voltage1	50-330 (V) : 200V class 50-660 (V) : 400V class	230 (WP/WN type) 400 (WP type) 460 (WN type)

## 5.10 Selecting control mode

**P<sub>Ł</sub>**: V/F control mode selection

- Function
  - With VF-FS1, the V/F controls shown below can be selected.
  - V/F constant
  - Variable torque
  - Automatic torque boost control
  - Vector control
  - Advanced energy saving
  - PM motor control





[Parameter setting]

Title	Function	Adjustment range	Default setting
P <sub>Ł</sub>	V/F control mode selection	0: V/F constant 1: Variable torque 2: Automatic torque boost control 3: Vector control 4: Advanced energy-saving 5: - (Do not select) 6: PM motor control	1

Steps in setting are as follows

(In this example, the V/F control mode selection parameter P<sub>Ł</sub> is set to 3 (Vector control).)

### ■ Setting V/F control mode selection to 3 (sensorless vector control)

Key operated	LED display	Operation
	0.0	Displays the operation frequency. (Perform during operation stopped.) (When standard monitor display selection F 7 1 0 is set to 0 [Operation frequency])
	RUF	The first basic parameter "RUF" (Wizard function) is displayed.
	P <sub>Ł</sub>	Press the Δ key to change the parameter to P <sub>Ł</sub> (V/F control mode selection).
	1	Press the ENT key to display the parameter setting. (Standard default setting: 1 (Variable torque)).
	3	Press the Δ key to change the parameter to 3 (vector control).
	3 ⇄ P <sub>Ł</sub>	Press the ENT key to save the changed parameter. P <sub>Ł</sub> and parameter set value "3" are displayed alternately.



**Warning:**

When setting the V/F control mode selection parameter ( $P\ 1$ ) to any number between  $2$  and  $5$ , be sure to set at least the following parameters.

$u\ 1$  (Base frequency): See the motor's nameplate.

$u\ 1\ u$  (Base frequency voltage): See the motor's nameplate.

$F\ 4\ 1\ 5$  (Motor rated current): See the motor's nameplate.

$F\ 4\ 1\ 5$  (No-load current of motor): Refer to the motor test report.

$F\ 4\ 1\ 7$  (Rated rotational speed of motor): See the motor's nameplate.

Set also other torque boost parameters ( $F\ 4\ 0\ 1$  to  $F\ 4\ 9\ 5$ ), as required.

**1) Constant torque characteristics**

Setting of V/F control mode selection  $P\ 1$  to  $0$  (V/F constant)

This is applied to load that requires the same torque at low speeds as at rated speeds.

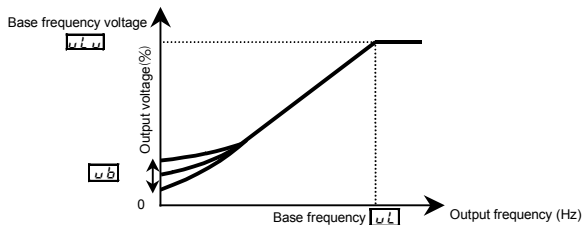

\* To increase the torque further, increase the setting value of the manual torque boost  $u\ b$ .

⇒ For more details, see 5.11.

**2) Setting for fans and pumps**

Setting of V/F control mode selection  $P\ 1$  to  $1$  (variable torque)

This is appropriate for load characteristics of such things as fans and blowers in which the torque in relation to load rotation speed is proportional to its square.

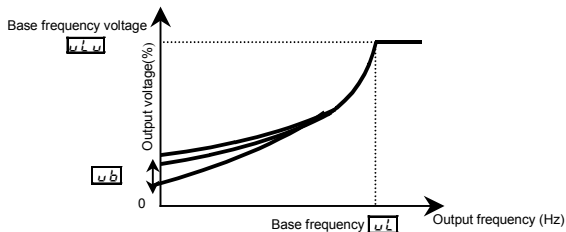

### 3) Increasing starting torque

Setting of V/F control mode selection  $P_{\xi}$  to  $\mathcal{Z}$  (automatic torque boost control)

Detects load current in all speed ranges and automatically adjusts voltage output (torque boost) from inverter. This gives steady torque for stable runs.

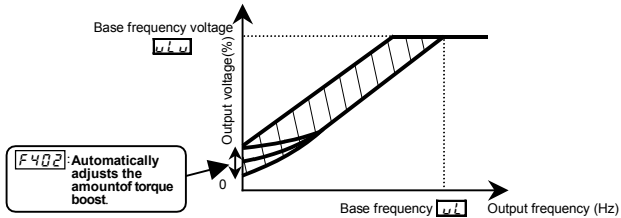

Note: This control system can oscillate and destabilize runs depending on the load. If that should happen, set V/F control mode selection  $P_{\xi}$  to  $\mathcal{B}$  (V/F constant) and increase torque manually.

### ★ Motor constant must be set

If the motor you are using is a 4P Toshiba standard motor and if it has the same capacity as the inverter, there is basically no need to set the motor constant. In any other case, be sure to set the parameters  $u_l$ ,  $u_l u$ ,  $F_4 15$  to  $F_4 17$  properly.

Be sure to set  $u_l$  (base frequency),  $u_l u$  (base frequency voltage),  $F_4 15$  (rated current of motor) and  $F_4 17$  (rated speed of motor) correctly, as specified on the motor's nameplate. For the setting of  $F_4 16$  (no-load current of motor), refer to the motor test report.

There are two procedures for setting the other motor constants.

- 1) The motor constant can be automatically set (auto-tuning). Set the extended parameter  $F_4 0 0$  to  $\mathcal{Z}$ .  
 ⇒ For details, see selection 1 in 6.15.1.
- 2) Each motor constant can be set individually. ⇒ For details, see selection 2 in 6.15.1.

### 4) Vector control - increasing starting torque and achieving high-precision operation.

Setting of V/F control mode selection  $P_{\xi}$  to  $\mathcal{J}$  (Vector control)

Using sensor-less vector control with a Toshiba standard motor will provide the highest torque at the low speed ranges.

- (1) Provides large starting torque.
- (2) Effective when stable operation is required to move smoothly up from the low speeds.
- (3) Effective in elimination of load fluctuations caused by motor slippage.

### ★ Motor constant must be set

If the motor you are using is a 4P Toshiba standard motor and if it has the same capacity as the inverter, there is basically no need to set the motor constant. In any other case, be sure to set the parameters  $\omega L$ ,  $\omega L v$ ,  $F 4 I 5$  to  $F 4 I 7$  properly.

Be sure to set  $\omega L$  (base frequency),  $\omega L v$  (base frequency voltage),  $F 4 I 5$  (rated current of motor) and  $F 4 I 7$  (rated speed of motor) correctly, as specified on the motor's nameplate. For the setting of  $F 4 I 5$  (no-load current of motor), refer to the motor test report.

There are two procedures for setting the other motor constants.

- 1) The motor constant can be automatically set (auto-tuning).  
Set the extended parameter  $F 4 Q Q$  to  $2$ . ⇒ For details, see selection 1 in 6.15.1.
- 2) Each motor constant can be set individually. ⇒ For details, see selection 2 in 6.15.1.

### 5) Advanced energy-saving

Setting of V/F control mode selection  $P 2$  to  $4$  (Advanced energy-saving)

Energy can be saved in all speed areas by detecting load current and flowing the optimum current that fits the load.

### ★ Motor constant must be set

If the motor you are using is a 4P Toshiba standard motor and if it has the same capacity as the inverter, there is no need to set the motor constant. In any other case, be sure to set the parameters  $\omega L$ ,  $\omega L v$ ,  $F 4 I 5$  to  $F 4 I 7$  properly.

Be sure to set  $\omega L$  (base frequency),  $\omega L v$  (base frequency voltage),  $F 4 I 5$  (rated current of motor) and  $F 4 I 7$  (rated speed of motor) correctly, as specified on the motor's nameplate. For the setting of  $F 4 I 5$  (no-load current of motor), refer to the motor test report.

There are two procedures for setting the other motor constants.

- 1) The motor constant can be automatically set (auto-tuning). Set the extended parameter  $F 4 Q Q$  to  $2$ .  
⇒ For details, see selection 1 in 6.15.1.
- 2) Each motor constant can be set individually. ⇒ For details, see selection 2 in 6.15.1.

### 6) Operating a permanent magnet motor

Setting of V/F control mode selection  $P 2$  to  $5$  (PM motor control)

Permanent magnet motors (PM motors) that are light, small in size and highly efficient, as compared to induction motors, can be operated in sensor-less operation mode.

Note that this feature can be used only for specific motors. For more information, contact your Toshiba dealer.

### 7) Precautions on vector control

- 1) When exercising vector control, be sure to set the extended parameters  $\omega L$ ,  $\omega L v$ ,  $F 4 I 5$  to  $F 4 I 7$  properly. Be sure to set  $\omega L$  (base frequency),  $\omega L v$  (base frequency voltage),  $F 4 I 5$  (rated current of motor) and  $F 4 I 7$  (rated speed of motor) correctly, as specified on the motor's nameplate. For the setting of  $F 4 I 5$  (no-load current of motor), refer to the motor test report.
- 2) The sensorless vector control exerts its characteristics effectively in frequency areas below the base frequency ( $\omega L$ ). The same characteristics will not be obtained in areas above the base frequency.
- 3) Set the base frequency to anywhere from 40 to 120Hz during vector control ( $P 2 = 3$ ).

- 4) Use a general purpose squirrel-cage motor with a capacity that is the same as the inverter's rated capacity or one rank below.  
The minimum applicable motor capacity is 0.1kW.
- 5) Use a motor that has 2-8 P.
- 6) Always operate the motor in single operation (one inverter to one motor). Sensorless vector control cannot be used when one inverter is operated with more than one motor.
- 7) The maximum length of wires between the inverter and motor is 30 meters. If the wires are longer than 30 meters, set standard auto-tuning with the wires connected to improve low-speed torque during sensorless vector control.  
However the effects of voltage drop cause motor-generated torque in the vicinity of rated frequency to be somewhat lower.
- 8) Connecting a reactor or surge voltage suppression filter between the inverter and the motor may reduce motor-generated torque. Setting auto-tuning may also cause a trip (E-tn) rendering sensorless vector control unusable.

8) The following table shows the relationship between the V/F control mode selection (P-1) and the motor constant parameter.

Under normal conditions, be sure to set or adjust the parameters marked with ©.

When making detailed settings, adjust the parameters marked with ○ as well, if necessary.

Do not adjust the parameters marked with ×, because they are invalid.

(For instructions about how to adjust the parameter F-400 and later, see section 6.17.)

■ Relationship between V/F control mode selection ( $P\checkmark$ ) and Motor constant parameter

⊙&○ : Valid, × : Invalid

Title	Function	Parameter $P\checkmark$ (V/F control mode selection)				
		0 V/F constant	1 Variable torque	2 Automatic torque boost control	3 Vector control	4 Energy- saving
$\omega L$	Base frequency 1	⊙	⊙	⊙	⊙	⊙
$\omega L \omega$	Base frequency voltage 1	⊙	⊙	⊙	⊙	⊙
$\omega b$	Torque boost value 1	⊙	⊙	×	×	×
$F 170$	Base frequency 2	○	×	×	×	×
$F 171$	Base frequency voltage 2	○	×	×	×	×
$F 172$	Torque boost value 2	○	×	×	×	×
$F 400$	Auto-tuning	×	×	○	○	○
$F 401$	Slip frequency gain	×	×	×	○	×
$F 402$	Automatic torque boost value	×	×	⊙	⊙	⊙
$F 415$	Motor rated current	○	○	⊙	⊙	⊙
$F 416$	Motor no-load current	×	×	○	○	○
$F 417$	Motor rated speed	○	○	⊙	⊙	⊙
$F 418$	Speed control response coefficient	×	×	○	○	○
$F 419$	Speed control stability coefficient	×	×	○	○	○
$F 480$	Exciting current coefficient	×	×	○	○	×
$F 485$	Stall prevention control coefficient 1	○	○	○	○	○
$F 492$	Stall prevention control coefficient 2	○	○	○	○	○
$F 494$	Motor adjustment coefficient	○	○	○	○	○
$F 495$	Maximum voltage adjustment coefficient	○	○	○	○	○
$F 496$	Waveform switching adjustment coefficient	○	○	○	○	○

⊙ : Be sure to set and adjust the parameters.

○ : Adjust the parameters if necessary.

## 5.11 Manual torque boost - increasing torque boost at low speeds

**ub** : Torque boost 1

- Function  
If torque is inadequate at low speeds, increase torque by raising the torque boost rate with this parameter.

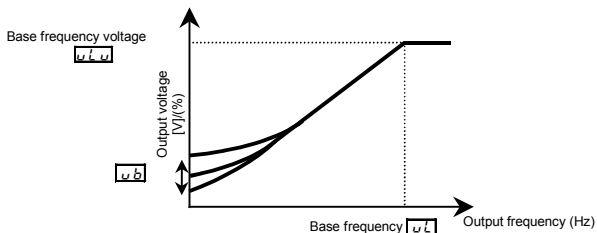

[Parameter setting]

Title	Function	Adjustment range	Default setting
<b>ub</b>	Torque boost 1	0.0 - 30.0 (%)	According to model ( $\Rightarrow$ See page K-14)

★ Valid when  $Pt$  is set to  $\bar{v}$  (V/F constant) or  $i$  (square reduction)

Note: The optimum value is programmed for each inverter capacity. Be careful not to increase the torque boost rate too much because it could cause an overcurrent trip at startup.

## 5.12 Setting the electronic thermal

**EH1** : Motor electronic-thermal protection level 1

**OL1** : Electronic thermal protection characteristic selection

**F173** : Motor electronic-thermal protection level 2

**F601** : Motor 150%-overload time limit

**F632** : Thermal memory selection

- Function  
This parameter allows selection of the appropriate electronic thermal protection characteristics according to the particular rating and characteristics of the motor.

[Parameter setting]						
Title	Function	Adjustment range				Default setting
$\underline{E}Hr$	Motor electronic thermal protection level 1	10 – 100 (%) / (A)				100
$\underline{O}Ln$	Electronic-thermal protection characteristic selection	Setting value	Standard motor	Overload protection	Overload stall	○
		0		○	×	
		1		○	○	
		2		×	×	
		3	×	○		
		4	○	×		
		5	○	○		
		6	×	×		
7	VF motor (special motor)	×	○			
$F173$	Motor electronic-thermal protection level 2	10 – 100 (%) / (A)				100
$F607$	Motor 150%-overload time limit	10 – 2400 (s)				300
$F632$	Thermal memory selection	0: Disabled 1: Enabled				0

\* ○ : valid, × : invalid

### 1) Setting the electronic thermal protection characteristics selection $\underline{O}Ln$ and motor electronic thermal protection level 1 $\underline{E}Hr$ , 2 $F173$

The electronic thermal protection characteristics selection  $\underline{O}Ln$  is used to enable or disable the motor overload trip function ( $\underline{O}L2$ ) and the overload stall function.

While the inverter overload trip ( $\underline{O}L1$ ) will be in constant detect operation, the motor overload trip ( $\underline{O}L2$ ) can be selected using the parameter  $\underline{O}Ln$ .

#### Explanation of terms

**Overload stall:** This is an optimum function for equipment such as fans, pumps and blowers with variable torque characteristics that the load current decreases as the operating speed decreases.

When the inverter detects an overload, this function automatically lowers the output frequency before the motor overload trip  $\underline{O}L2$  is activated. This function operates a motor at frequencies that allow the load current to keep its balance so that the inverter can continue operation without being tripped.

### [Using standard motors (other than motors intended for use with inverters)]

When a motor is used in the lower frequency range than the rated frequency, that will decrease the cooling effects for the motor. This speeds up the start of overload detection operations when a standard motor is used in order to prevent overheating.

### ■ Setting of electronic thermal protection characteristics selection $0L7$

Setting value	Overload protection	Overload stall
0	○	×
1	○	○
2	×	×
3	×	○

○ : valid, × : invalid

### ■ Setting of motor electronic thermal protection level $1\text{tHr}$ (Same as $F173$ )

If the capacity of the motor is smaller than the capacity of the inverter, or the rated current of the motor is smaller than the rated current of the inverter, adjust the electronic thermal protection level  $1\text{tHr}$  so that it fits the motor's rated current.

\* If the indications are in percentages (%), then 100% equals the inverter's rated output current (A).

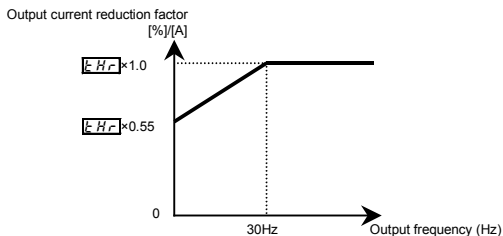

Note: The motor overload protection start level is fixed at 30Hz.

[Example of setting: When the VFFS1-2007PM is running with a 0.4kW motor having 2A rated current]

Key operated	LED display	Operation
	0.0	Displays the operation frequency. (Perform during operation stopped.) (When standard monitor display selection $F710$ is set to 0 [Operation frequency])
(MODE)	RUF	The first basic parameter "RUF" (Wizard function) is displayed.
( $\Delta$ ) ( $\nabla$ )	tHr	Press either the $\Delta$ key or the $\nabla$ key to change the parameter to tHr.
(ENT)	100	Press the ENT key to display the parameter setting. (Standard default setting: 100%)
( $\Delta$ )	42	Press the $\Delta$ key to change the parameter to 42% (=motor rated current/inverter output rated current x 100=2.0/4.8x100).
(ENT)	42 $\leftrightarrow$ tHr	Press the ENT key to save the changed parameter. tHr and the parameter are displayed alternately.

Note: The rated output current of the inverter should be calculated from the rated current, regardless of the setting of the PWM carrier frequency parameter ( $F300$ ).



[Using a VF motor (motor for use with inverter)]

■ Setting of electronic thermal protection characteristics selection  $\text{P}17$

Setting value	Overload protection	Overload stall
4	○	×
5	○	○
6	×	×
7	×	○

○ : valid, × : invalid

VF motors (motors designed for use with inverters) can be used in frequency ranges lower than those for standard motors, but their cooling efficiency decreases at frequencies below 6Hz.

■ Setting of motor electronic thermal protection level  $1\text{P}17$  (Same as  $\text{F}17$ )

If the capacity of the motor is smaller than the capacity of the inverter, or the rated current of the motor is smaller than the rated current of the inverter, adjust the electronic thermal protection level  $1\text{P}17$  so that it fits the motor's rated current.

\* If the indications are in percentages (%), then 100% equals the inverter's rated output current (A).

Output current reduction factor [%]/[A]

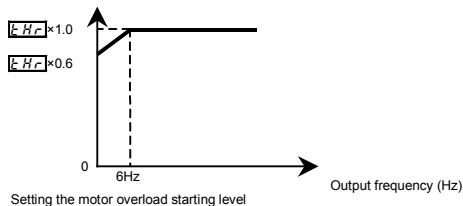

2) Motor 150%-overload time limit  $\text{F}607$

Parameter  $\text{F}607$  is used to set the time elapsed before the motor trips under a load of 150% (overload trip  $\text{P}12$ ) within a range of 10 to 2400 seconds.

3) Inverter over load characteristics

Set to protect the inverter unit. Cannot be changed or turned off by parameter setting.

To prevent the inverter overload trip function ( $\text{P}11$ ) from being activated too easily, lower the stall prevention level ( $\text{F}607$ ) or increase the acceleration time ( $\text{R}11$ ) or deceleration time ( $\text{d}E1$ ).

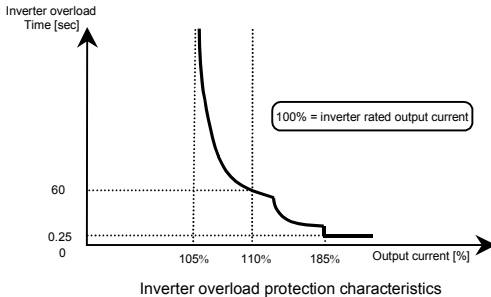

\* To protect the inverter, overload trip or overcurrent trip activate in a short period of time when output current reaches 110% or higher.

#### 4) Thermal memory selection F632

At the main power off, it is selectable whether retention of electric thermal calculation values or not.

**0**: In case of not activated

The calculated value of the electric thermal is not memorized at power-off.

The calculated value of the electric thermal and the trip state can always be reset.

Don't reset the unit trip state continually, it may cause the motor and the unit failure.

**1**: In case of activated

The calculated value of the electric thermal is memorized at power-off.

The trip state can always be reset but the calculated value of the electric thermal can not be reset.

## 5.13 Preset-speed operation (speeds in 7 steps)

Fr1 - Fr7: Preset-speed operation frequencies 1-7

- Function

A maximum of 7 speed steps can be selected just by switching an external contact signal. Multi-speed frequencies can be programmed anywhere from the lower limit frequency  $L_L$  to the upper limit frequency  $U_L$ .

[Setting method]

1) Run/stop

The starting and stopping control is done from the terminal board.

Title	Function	Adjustment range	Setting value
<span style="border: 1px solid black; padding: 2px;">Fn0d</span>	Command mode selection	0: Terminal board 1: Operation panel 2: RS485 communication	0

Note: If speed commands (analog signal or digital input) are switched in line with preset-speed operations, select the terminal board using the frequency setting mode selection Fn0d. → See step 3) or section 5.3.

2) Preset-speed frequency setting

Set the speed (frequency) of the number of steps necessary.

Title	Funtion	Adjustment range	Default setting
$S_r 1$	Preset-speed operation frequencies 1	$L L - U L$ (Hz)	15.0
$S_r 2$	Preset-speed operation frequencies 2	$L L - U L$ (Hz)	20.0
$S_r 3$	Preset-speed operation frequencies 3	$L L - U L$ (Hz)	25.0
$S_r 4$	Preset-speed operation frequencies 4	$L L - U L$ (Hz)	30.0
$S_r 5$	Preset-speed operation frequencies 5	$L L - U L$ (Hz)	35.0
$S_r 6$	Preset-speed operation frequencies 6	$L L - U L$ (Hz)	40.0
$S_r 7$	Preset-speed operation frequencies 7	$L L - U L$ (Hz)	45.0

Examples of preset-speed contact input signals: Slide switch SW4 set to sink logic

O: ON - OFF (Speed commands other than preset-speed commands are valid when all are OFF)

Terminal	Preset-speed						
	1	2	3	4	5	6	7
R-CC	○	-	○	-	○	-	○
RES-CC	-	○	○	-	-	○	○
VIA-CC	-	-	-	○	○	○	○

- ★ Preset-speed commands are not allocated to standard default setting. Use the input terminal function selection to allocate SS1 to SS3 terminal.

Terminal R..... Input terminal function selection 2 (R)  
 $F \uparrow 1 2 = 5$  (Preset-speed command 1: SS1)

Terminal RES..... Input terminal function selection 3 (RES)  
 $F \uparrow 1 3 = 7$  (Preset-speed command 2: SS2)

Terminal VIA ..... Input terminal function selection 8 (VIA)  
 $F \uparrow 1 8 = 8$  (Preset-speed command 3: SS3)

Analogue/contact input function selection

$F \uparrow 1 9 = 1$  (VIA-contact input(Sink))

\*When VIA terminal is used for the contact input terminal, always contact a resistor between VIA and P24. (Recommended value 1/2W-4.7kΩ)

[Example of a connection diagram]  
 (SW4 set to sink logic)

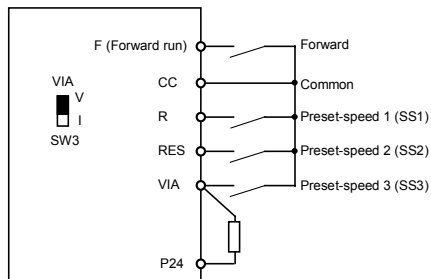

3) Using other speed commands with preset-speed command

Command mode selection Command		0: Terminal board			1: Operation panel			2: Serial communication		
Frequency setting mode selection F.F.F.d		1: VIA 2: VIB 5: UP/DOWN	3: Operation panel	4: Communication	1: VIA 2: VIB 5: UP/DOWN	3: Operation panel	4: Communication	1: VIA 2: VIB 5: UP/DOWN	3: Operation panel	4: Communication
Preset-speed command	Entered	Preset-speed command valid Note)			Terminal command valid	Operation panel command valid	Terminal command valid	Operation panel command valid	Communication command valid	Communication command valid
	Not entered	Terminal command valid	Operation panel command valid	Communication command valid	(The inverter doesn't accept Preset-speed command.)			(The inverter doesn't accept Preset-speed command.)		

Note: The preset-speed command is always given priority when other speed commands are input at the same time.

Below is an example of 7-step speed operation.

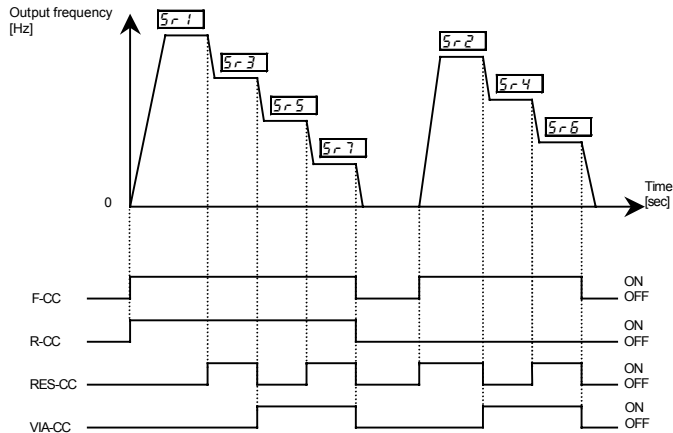

Example of 7-step speed operation

## 6. Extended parameters

Extended parameters are provided for sophisticated operation, fine adjustment and other special purposes. Modify parameter settings as required. ⇒ See section 11, table of extended parameters.

### 6.1 Input/output parameters

#### 6.1.1 Low-speed signal

**F 100**: Low-speed signal output frequency

- Function
  - When the output frequency exceeds the setting of **F 100** an ON signal will be generated. This signal can be used as an electromagnetic brake excitation/release signal.
  - This signal can also be used as an operation signal when **F 100** is set to 0.0Hz, because an ON signal is put out if the output frequency exceeds 0.0Hz.
  - ★ Relay output (250Vac-1A (cosφ=1), 30Vdc-0.5A, 250Vac-0.5A (cosφ=0.4) at RY-RC, FLA-FLC-FLB terminals.

[Parameter setting]

Title	Function	Adjustment range	Default setting
<b>F 100</b>	Low-speed signal output frequency	0.0 ~ FH (Hz)	0.0

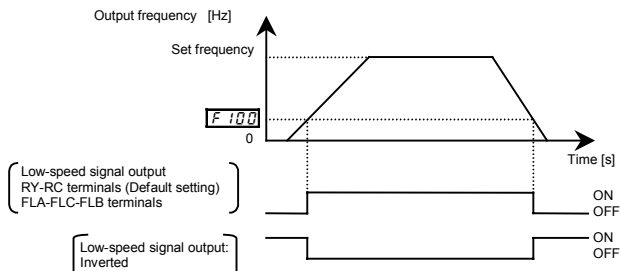

An example of the connection of the relay output terminals

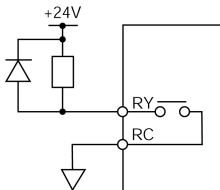

- Output terminal setting

Output of the low-speed signal (ON signal) between the RY and RC terminals is the factory default setting of the output terminal selection parameter. This setting must be changed to invert the polarity of the signal.

[Parameter setting]

Title	Function	Adjustment range	Setting value
<i>F 130</i>	Output terminal selection 1A (RY-RC)	0-255 (=> See page K-17)	4 LOW (Low speed signal - ON signal) or 5 LOWF (Low speed signal - OFF signal)

## 6.1.2 Output of designated frequency reach signal

***F 102***: Speed reach detection band

- Function

When the output frequency becomes equal to the setting by designated frequency  $\pm F 102$ , an ON or OFF signal is generated.

[Parameter setting]

Title	Function	Adjustment range	Default setting
<i>F 102</i>	Speed reach detection band	0.0 ~ <i>F H</i> (Hz)	2.5

[Parameter setting]

Title	Function	Adjustment range	Setting value
<i>F 130</i>	Output terminal selection 1A (RY-RC)	0-255 (=> See page K-17)	6: RCH (designated frequency - ON signal), or 7: RCHN (designated frequency - OFF signal)

Note: Select the *F 130* parameter to specify FLA-FLC-FLB terminal output.

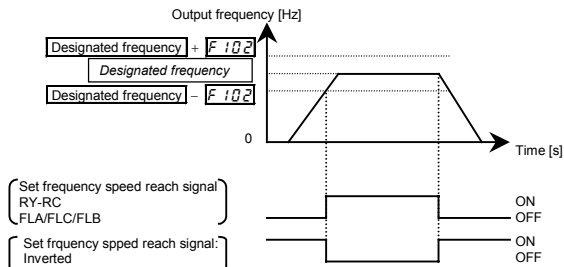

### 6.1.3 Output of set frequency speed reach signal

$F101$ : Speed reach setting frequency

$F102$ : Speed reach detection band

- Function  
When the output frequency becomes equal to the frequency set by  $F101 \pm F102$ , an ON or OFF signal is generated.

[Parameter setting]

Title	Function	Adjustment range	Default setting
$F101$	Speed reach setting frequency	0.0 ~ $FH$ (Hz)	0.0
$F102$	Speed reach detection band	0.0 ~ $FH$ (Hz)	2.5

[Parameter setting]

Title	Function	Adjustment range	Setting value
$F130$	Output terminal selection 1A (RY-RC)	0-255 ( $\Rightarrow$ See page K-17)	8: RCHF (designated frequency - ON signal), or 9: RCHFN (designated frequency - OFF signal)

Note: Select the  $F132$  parameter function No. 8 or 9 to specify FLA-FLC-FLB terminal output.

If the detection band value + the set frequency is less than the designated frequency

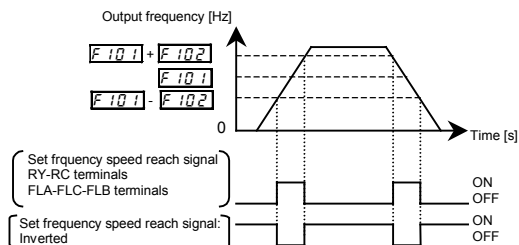

## 6.1.4 Over set frequency attainment signal

$F101$  : Speed reach setting frequency

$F102$  : Speed reach detection band

### • Function

When the output frequency becomes equal to more than  $F101 + F102$ , ON-signal is generated. After that, the output frequency becomes equal to less than  $F101 - F102$ , OFF-signal is generated.

[Parameter setting]

Title	Function	Adjustment range	Default setting
$F101$	Speed reach setting frequency	0.0- $FH$ (Hz)	0.0
$F102$	Speed reach detection band	0.0- $FH$ (Hz)	2.5

[Parameter setting]

Title	Function	Adjustment range	Setting value
$F130$	Output terminal selection 1A (RY-RC)	0-255	66: RCHO (Over set frequency attainment signal - ON signal), or 67: RCHON (Over set frequency attainment signal - OFF signal)

Note: Select the  $F132$  parameter to specify FLA-FLC-FLB terminal output.



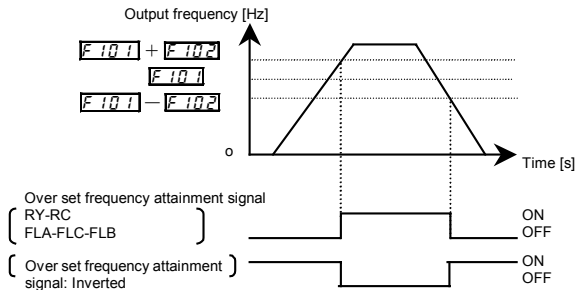

## 6.2 Input signal selection

### 6.2.1 Changing the functions of VIA terminal

**F109**: VIA terminal function selection

- Function  
This parameter allows you to choose between signal input and contact signal input for the VIA terminal

[Parameter setting]

Title	Function	Adjustment range	Default setting
F109	Analog/contact input function selection (VIA terminal)	0: VIA - analog input 1: VIA - contact input (Sink) 2: VIA - contact input (Source)	0

\* When using the VIA terminal as contact input terminals in sink logic connection, be sure to insert a resistor between the P24 terminal and the VIA terminal. (Recommended resistance: 4.7kΩ-1/2W)

Note: When using the VIA terminal as a contact input terminal, be sure to turn the VIA (SW3) slide switch to the V position.

★ The figure on the right shows an example of the connection of input terminal VIA when it is used as contact input terminal. This example illustrates the connection when the inverter is used in sink (Negative) logic mode.

★ In case source (Positive) logic mode, connect the resistor between VIA and CC.

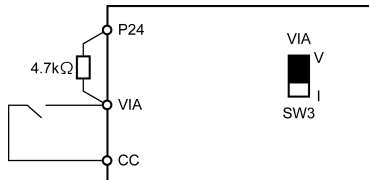

## 6.3 Terminal function selection

### 6.3.1 Keeping an input terminal function always active (ON)

**F108**: Always-active function selection 1

**F110**: Always-active function selection 2

- Function

This parameter specifies an input terminal function that is always to be kept active (ON).

[Parameter setting]

Title	Function	Adjustment range	Default setting
<b>F108</b>	Always-active function selection 1	0-72 (⇒ See page K-15)	0 (No function)
<b>F110</b>	Always-active function selection 2	0-72 (⇒ See page K-15)	1 (Standby)

\* Coast stop

The standard default setting is for deceleration stop.  
To make a coast stop, assign a "1(ST)" terminal function to an idle terminal using the programmable terminal function.

Change to **F110=0**.

For coast stop, OFF the ST terminal when stopping the motor in the state described at left. The monitor on the inverter at this time will display **0FF**.

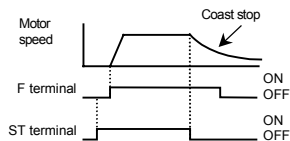

### 6.3.2 Modifying input terminal functions

**F111**: Input terminal selection 1 (F)

**F112**: Input terminal selection 2 (R)

**F113**: Input terminal selection 3 (RES)

**F118**: Input terminal selection 8 (VIA)

- **Function**  
Use the above parameters to send signals from an external programmable controller to various control input terminals to operate and/or set the inverter.  
The desired contact input terminal functions can be selected from 57 types (0 to 71). This gives system design flexibility.
- The functions of the VIA terminal can be selected between analog input and contact input by changing parameter settings  $F109$ .  
To use the VIA terminal as contact input terminals, you need to set  $F109$  to the number (1 or 2) that suits your needs, since analog input (voltage signal input) is assigned to the terminals by default.

### ■ Setting of contact input terminal function

Terminal symbol	Title	Function	Adjustment range	Default setting
-	$F108$	Always-active function selection 1	0-72 (⇒ See page K-15)	0
-	$F110$	Always-active function selection 2		1 (ST)
F	$F111$	Input terminal selection 1 (F)		2 (F)
R	$F112$	Input terminal selection 2 (R)		3 (R)
RES	$F113$	Input terminal selection 3 (RES)		10 (RES)
VIA	$F118$	Input terminal selection 8 (VIA)	0-72 Note 2)	6 (SS1)

Note 1: The function that has been selected using  $F108$  and  $F110$  (always-active function selection parameter) are always activated.

Note 2: When using the VIA terminal as contact input terminals in sink logic connection, be sure to insert a resistor between the P24 terminal and the VIA terminal. (Recommended resistance: 4.7kΩ-1/2W)  
Be sure to turn the VIA (SW3) slide switch to the V position.

Note 3:  $F118$  (VIA): Enabled only when  $F109=1$  or  $2$

Disabled and the set value cannot be read out, if  $F109$  is set at  $0$ .

■ Connection method

1) A-contact input

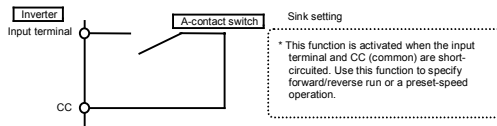

2) Connection with transistor output

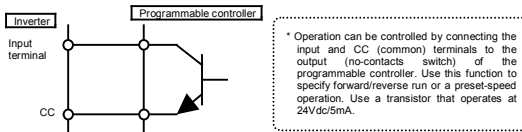

\* Interface between programmable controller and inverter

Note: When using a programmable controller with open collector outputs for control, connect it to the PCL terminal, as shown in the figure below, to prevent the inverter from malfunctioning because of a current that flows in.

**Also, be sure to turn the SW4 slide switch to the PLC position.**

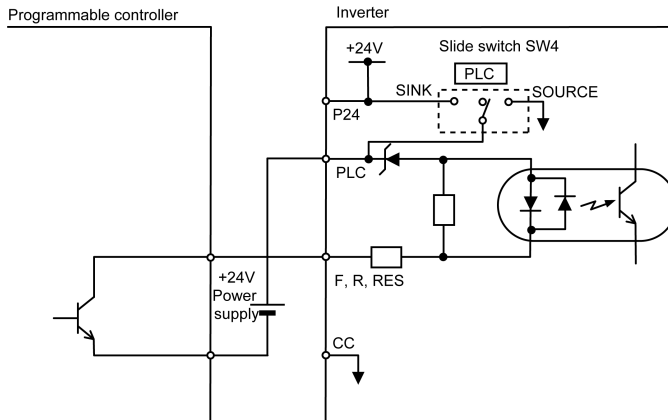

### 3) Sink (Negative) logic / Source (Positive) logic input

Sink logic/source logic (input terminal logic) switching is possible.

⇒ For more details, see section 2.3.2.

## 6.3.3 Modifying output terminal functions

**F 130**: Output terminal selection 1A (RY-RC)

**F 132**: Output terminal selection 3 (FLA, FLB, FLC)

- Function

Use the above parameters to send various signals from the inverter to external equipment.

By setting parameters for the RY-RC and FL (FLA, FLB and FLC) terminals on the terminal board, you can use 58 functions and functions obtained by combining them.

To assign only one function to RY-RC terminals, assign the function to *F 130* while leaving *F 137* and *F 139* as they are set by default.

### ■ Examples of application

Function of FLA, B, C:  
Can be set using parameter *F 132*

Function of RY-RC:  
Can be set using parameter *F 130, 137, 139*

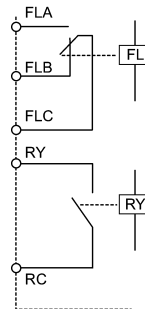

### ■ Assigning one function to an output terminal

Terminal symbol	Title	Function	Adjustment range	Default setting
RY - RC	<i>F 130</i>	Output terminal selection 1A	0-255 (⇒ See page K-17)	4 (Low-speed detection signal)
FL (A, B, C)	<i>F 132</i>	Output terminal selection 3		10(Failure FL)

- ★ When assigning one function to RY-RC terminals, set parameter *F 130* only.  
Do not change but leave parameters *F 131* and *F 139* as they were set by default.  
(Default setting: *F 131*=255, *F 139*=0)

## 6.3.4 Assigning two functions to an output terminal

***F 130***: Output terminal selection 1A (RY-RC)

***F 131***: Output terminal selection 1B (RY-RC)

***F 139***: Output terminal logic selection (RY-RC)

- Function  
2 different functions can be assigned to the terminal board output terminal RY-RC.  
Signals of 2 functions of the logical product (AND) or logical sum (OR) selected from 58 functions can be output to 1 output terminal.

(1) A signal is sent out when the two functions assigned are activated simultaneously.

Terminal symbol	Title	Function	Adjustment range	Default setting
RY - RC	<i>F 130</i>	Output terminal selection 1A	0~255 (⇒ See page K-17)	4 (Low-speed detection signal)
RY - RC	<i>F 137</i>	Output terminal selection 1B		255 (Always ON)
RY - RC	<i>F 139</i>	Output terminal logic selection	0: <i>F 130</i> and <i>F 137</i> 1: <i>F 130</i> or <i>F 137</i>	0

- ★ Two different functions can be assigned to terminals RY-RC.
- ★ If parameter *F 139* is set to 0 (default), a signal will be sent out when the two functions assigned are activated simultaneously.  
Terminals RY-RC: Send out a signal when the functions assigned with *F 130* and *F 137* are activated simultaneously.

★ Timing chart

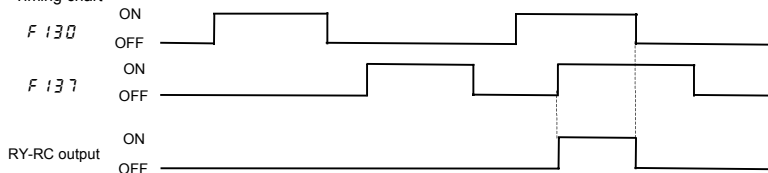

- ★ Only one function can be assigned to terminals FLA-FLB-FLC at a time.

(2) A signal is sent out when either of the two functions assigned is activated.

- ★ Two different functions can be assigned to terminals RY-RC.
- ★ If parameter *F 139* is set to 1, a signal will be sent out when either of the two functions assigned is activated.  
Terminals RY-RC: Send out a signal when either of the functions set with *F 130* and *F 137* is activated.
- ★ Timing chart

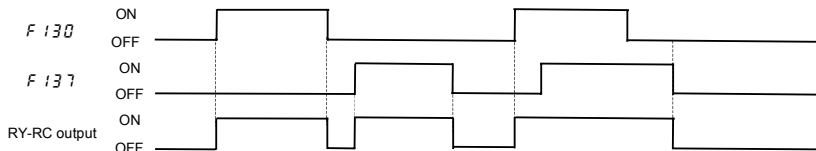

- ★ Only one function can be assigned to terminals FLA-FLB-FLC at a time.

### (3) Holding the output of signals in ON status

- ★ If the conditions for activating the functions assigned to output terminals RY-RC agree with and as a result the output of signals is put in ON status, the output of signals is held ON, even if the conditions change. (Output terminal holding function)
- ★ Assign input terminal function 62 to a contact input terminal available.

#### ■ Input terminal function

Function No.	Code	Function	Action
62	HDRY	Holding of RY-RC terminal output	ON: Once turned on, RY-RC is held on. OFF: The status of RY-RC changes in real time according to conditions.

- ★ Once output terminal RY-RC is turned on when the contact input terminal to which one of the above functions (function 62) is assigned is ON, output terminal RY-RC is held ON.

## 6.3.5 Delay relay output

**F 146**: Delay time for RY\_RC relay

**F 147**: Delay time for FL relay

- Function  
You can use the delay time of output terminal by f146 (Delay time for RY\_RC relay) and f147 (Delay time for FL relay). Each output when the detection time doesn't exceed the delay time become non-active.

#### [Parameter setting]

Title	Function	Adjustment range	Default setting
<b>F 146</b>	Delay time for RY_RC relay	0.0 ~ 60 (sec)	0.0
<b>F 147</b>	Delay time for FL relay	0.0 ~ 60 (sec)	0.0

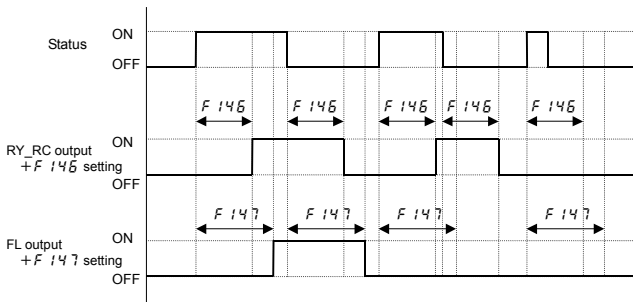



### 6.3.6 Analog VIA / VIB detection

**F 150**: Analog VIA detection level

**F 151**: Analog VIA detection band

**F 152**: Analog VIB detection level

**F 153**: Analog VIB detection band

- Function  
Output relay can be control by value of analog VIA / VIB.  
It is turned on with  $F 150 + F 151$  or more for VIA(%), and it is turned off with  $F 150 - F 151$  or less for VIA(%). In this case, set 62 or 63 to output-terminal function ( $F 130 \sim F 132$  .  $F 137$ ).  
On VIB(%), these parameter are  $F 152$  and  $F 153$  , output-terminal function number is 64 or 65.

Parameter setting

Title	Function	Adjustment range	Default setting
<b>F 150</b>	Analog VIA detection level	0-100 (%)	0
<b>F 151</b>	Analog VIA detection band	0-20 (%)	3
<b>F 152</b>	Analog VIB detection level	0-100 (%)	0
<b>F 153</b>	Analog VIB detection band	0-20 (%)	3

Parameter setting

Title	Function	Adjustment range	Default setting
<b>F 130</b>	Output terminal selection 1A (RY-RC)	0-255	62: VIAD (Analog VIA detection - ON signal), or 63: VIADN (Analog VIA detection - OFF signal) 64: VIBD (Analog VIB detection - ON signal), or 65: VIBDN (Analog VIB detection - OFF signal)

Note: Select the f132 parameter to specify FLA-FLC-FLB terminal output.

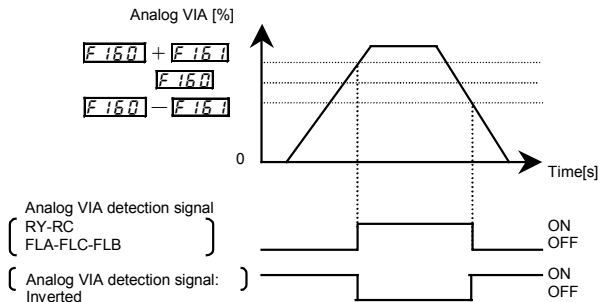

### 6.3.7 Comparing the frequency command values

**F167**: Frequency command agreement detection range

**F00d**: Frequency setting mode selection 1

**F207**: Frequency setting mode selection 2

- Function

If the frequency command value specified using **F00d** (or **F207**) almost agrees with the frequency command value from the VIA and VIB terminal with an accuracy of  $\pm F167$ , an ON or OFF signal will be sent out.

[Parameter setting]

Title	Function	Adjustment range	Default setting
<b>F167</b>	Frequency command agreement detection range	0.0 ~ <b>FH</b> (Hz)	2.5
<b>F00d</b>	Frequency setting mode selection 1	1-5	1
<b>F207</b>	Frequency setting mode selection 2		2

Note: When using VIA terminal, set **F130** or **F132** respectively to 52 or 53 to put out signals to RY-RC or FLA-FLB-FLC.

When using VIB terminal, set **F130** or **F132** respectively to 60 or 61 to put out signals to RY-RC or FLA-FLB-FLC.

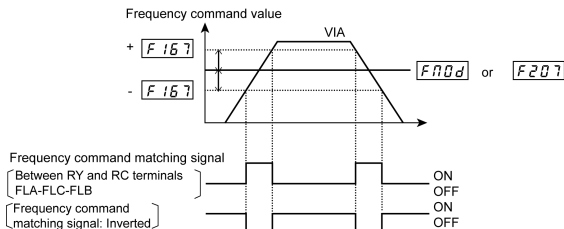

Note: This function can be used, for example, to send out a signal indicating whether the amount of processing and the amount of feedback agree with each other when the PID function is in use.

⇒ For an explanation of the PID function, see section 6.14.

## 6.4 Basic parameters 2

### 6.4.1 Switching motor characteristics via terminal input

**F170**: Base frequency 2

**F171**: Base frequency voltage 2

**F172**: Torque boost 2

**F173**: Motor electronic-thermal protection level 2

**F185**: Stall prevention level 2

- Function

Use the above parameters to switch the operation of two motors with a single inverter and to select motor V/F characteristics (two types) according to the particular needs or operation mode.

Note: The  $P_L$  (V/F control mode selection) parameter is enabled only for motor1.

If motor 2 is selected, V/F control will be given constant torque characteristics.

[Parameter setting]

Title	Function	Adjustment range	Default setting
<i>F 170</i>	Base frequency 2	25.0-200.0 (Hz)	50.0 (WP type) 60.0 (WN type)
<i>F 171</i>	Base frequency voltage 2	50-330 (V) : 200V class 50-660 (V) : 400V class	230 (WP/WN type) 400 (WP type) 460(WN type)
<i>F 172</i>	Torque boost 2	0.0-30.0 (%)	Depending on model (⇒ See page K-14)
<i>F 173</i>	Motor electronic-thermal protection level 2	10-100 (%) / (A)	100
<i>F 185</i>	Stall prevention level 2	10-110 (%) / (A),	110

## ■ Setting of switching terminals

The terminal for switching to motor 2 needs to be set, since this function is not assigned under the default setting. Assign this function to an idle terminal.

The parameters to be switched depend on the particular identification number of the input terminal selection function.

Input terminal function number				Parameters used and applicable parameters
5 AD2	39 VF2	40 MOT2	61 OCS2	
OFF	OFF	OFF	OFF	Default setting: $Pt, uL, uLv, ub, tHr, ACC, dEC, F502, F601$
ON	OFF	OFF	OFF	$ACC \rightarrow F500, dEC \rightarrow F501, F502 \rightarrow F503$
OFF	OFF	OFF	ON	$F601 \rightarrow F185$
OFF	ON	OFF	OFF	$Pt = 0, uL \rightarrow F170, uLv \rightarrow F171, ub \rightarrow F172, tHr \rightarrow F173$
-	-	ON	-	$Pt = 0, uL \rightarrow F170, uLv \rightarrow F171, ub \rightarrow F172, tHr \rightarrow F173, F601 \rightarrow F185, ACC \rightarrow F500, dEC \rightarrow F501, F502 \rightarrow F503$

Note: The parameters  $uL, uLv, Pt, F170$  and  $F171$  cannot be switched during operation. You need to stop operation when switching them.

## 6.5 Frequency priority selection

### 6.5.1 Using a frequency command according to the particular situation

**F10d**: Frequency setting mode selection 1

**F200**: Frequency priority selection

**F207**: Speed setting mode selection 2

- Function
  - These parameters are used to switch between two types of frequency command signals.
    - Setting by parameters
    - Switching by frequency
    - Switching via terminal board input

[Parameter setting]			
Title	Function	Adjustment range	Default setting
<i>F<math>\bar{N}\bar{Q}\bar{d}</math></i>	Frequency setting mode selection 1	1: VIA 2: VIB 3: Operation panel 4: RS485 communication 5: UP/DOWN from external contact	1
<i>F<math>\bar{2}\bar{Q}\bar{Q}</math></i>	Frequency priority selection	0: <i>F<math>\bar{N}\bar{Q}\bar{d}</math></i> (Switchable to <i>F<math>\bar{2}\bar{Q}\bar{Q}</math></i> by the input terminal) 1: <i>F<math>\bar{N}\bar{Q}\bar{d}</math></i> ( <i>F<math>\bar{2}\bar{Q}\bar{Q}</math></i> for output frequencies equal to or lower than 1.0 Hz)	0
<i>F<math>\bar{2}\bar{Q}\bar{Q}</math></i>	Frequency setting mode selection 2	1: VIA 2: VIB 3: Operation panel 4: RS485 communication 5: UP/DOWN from external contact	2

### 1) External switching (Input terminal function 38 : FCHG enabled)

**Frequency priority selection parameter *F $\bar{2}\bar{Q}\bar{Q}$*  = 0**

Switching between the command specified with *F $\bar{N}\bar{Q}\bar{d}$*  and *F $\bar{2}\bar{Q}\bar{Q}$*  can be made by entering a command from a terminal board.

To do so, however, the frequency command forced switching function (input terminal function selection: 38) needs to be set beforehand to an input terminal board.

If an OFF command is entered to the input terminal board: The command specified with *F $\bar{N}\bar{Q}\bar{d}$*  will be selected.

If an ON command is entered to the input terminal board: The command specified with *F $\bar{2}\bar{Q}\bar{Q}$*  will be selected.

### 2) Automatic switching by frequency command

**Frequency priority selection parameter *F $\bar{2}\bar{Q}\bar{Q}$*  = 1**

The switching between the command specified with *F $\bar{N}\bar{Q}\bar{d}$*  and *F $\bar{2}\bar{Q}\bar{Q}$*  is done automatically according to the frequency command entered.

If the frequency set with *F $\bar{N}\bar{Q}\bar{d}$*  is above 1Hz: The command specified with *F $\bar{N}\bar{Q}\bar{d}$*  will be selected.

If the frequency set with *F $\bar{N}\bar{Q}\bar{d}$*  is 1Hz or less: The command specified with *F $\bar{2}\bar{Q}\bar{Q}$*  will be selected.

## 6.5.2 Setting frequency command characteristics

**F201**: VIA input point 1 setting

**F202**: VIA input point 1 frequency

**F203**: VIA input point 2 setting

**F204**: VIA input point 2 frequency

**F210**: VIB input point 1 setting

**F211**: VIB input point 1 frequency

**F212**: VIB input point 2 setting

**F213**: VIB input point 2 frequency

**F811**: Communication command point 1 setting

**F812**: Communication command point 1 frequency

**F813**: Communication command point 2 setting

**F814**: Communication command point 2 frequency

- Function

These parameters adjust the output frequency according to the externally applied analog signal (0-10Vdc voltage, 4-20mAdc current) and the entered command for setting an external contact frequency.

- ★ To fine adjust the frequency command characteristics for VIA/VIB input, use the parameters **F470** to **F473**. ⇒ See section 6.5.4.

[Parameter setting]

Title	Function	Adjustment range	Default setting
F201	VIA input point 1 setting	0-100 (%)	0
F202	VIA input point 1 frequency	0.0-200.0 (Hz)	0.0
F203	VIA input point 2 setting	0-100 (%)	100
F204	VIA input point 2 frequency	0.0-200.0 (Hz)	50.0 (WP type) 60.0 (WN type)
F210	VIB input point 1 setting	0-100 (%)	0
F211	VIB input point 1 frequency	0.0-200.0 (Hz)	0.0
F212	VIB input point 2 setting	0-100 (%)	100
F213	VIB input point 2 frequency	0.0-200.0 (Hz)	50.0 (WP type) 60.0 (WN type)
F811	Communication command point 1 setting	0-100 (%)	0
F812	Communication command point 1 frequency	0.0-200.0 (Hz)	0.0
F813	Communication command point 2 setting	0-100 (%)	100
F814	Communication command point 2 frequency	0.0-200.0 (Hz)	50.0 (WP type) 60.0 (WN type)

Note: Don't set the same value between point 1 and point 2. If set the same value, the Error is displayed.

1) 0-10Vdc voltage input adjustment (VIA, VIB)

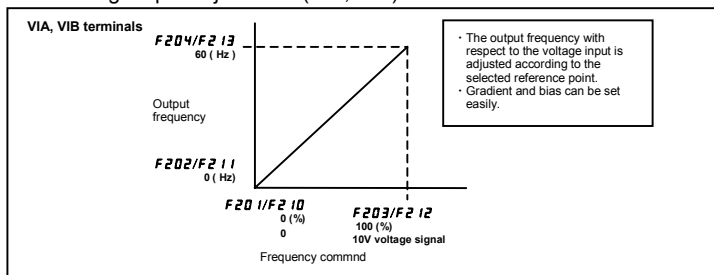

2) 4-20mA current input adjustment (VIA: VIA (SW3) slide switch in the I position)

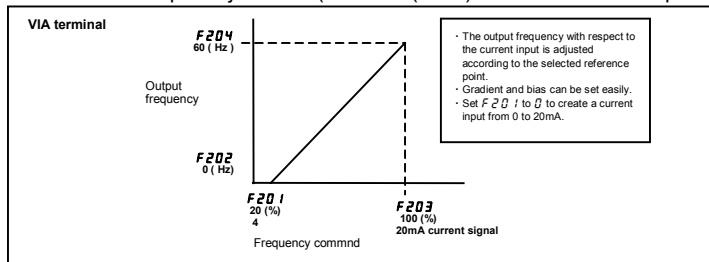

### 6.5.3 Setting of frequency with the input from an external contact

**F264**: External contact input - UP response time

**F265**: External contact input - UP frequency steps

**F266**: External contact input - DOWN response time

**F267**: External contact input - DOWN frequency steps

**F268**: Initial up/down frequency

**F269**: Change of the initial up/down frequency

- Function

These parameters are used to set an output frequency by means of a signal from an external device.

Title	Function	Adjustment range	Default setting
F264	External contact input - UP response time	0.0 - 10.0 (s)	0.1
F265	External contact input - UP frequency steps	0.0 - FH (Hz)	0.1
F266	External contact input - DOWN response time	0.0 - 10.0 (s)	0.1
F267	External contact input - DOWN frequency steps	0.0 - FH (Hz)	0.1
F268	Initial up/down frequency	LL - UL (Hz)	0.0
F269	Change of the initial up/down frequency	0: Not changed 1: Setting of F268 changed when power is turned off	1

\* These functions take effect when parameter *F70d* (frequency setting mode selection 1) is set to 5 or parameter *F207* (frequency setting mode selection 2) is set to 5 is enabled.

#### ■ Adjustment with continuous signals (Parameter-setting example 1)

Set parameters as follows to adjust the output frequency up or down in proportion to the frequency adjustment signal input time:

Panel frequency incremental gradient =  $F265/F264$  setting time

Panel frequency decremental gradient =  $F267/F266$  setting time

Set parameters as follows to adjust the output frequency up or down almost in synchronization with the adjustment by the panel frequency command:

$$F264 = F266 = 1$$

$$(FH/RC) \text{ (or } F500) \geq (F265/F264 \text{ setting time)}$$

$$(FH/dE) \text{ (or } F501) \geq (F267/F266 \text{ setting time)}$$



## &lt;&lt;Sample sequence diagram 1: Adjustment with continuous signals&gt;&gt;

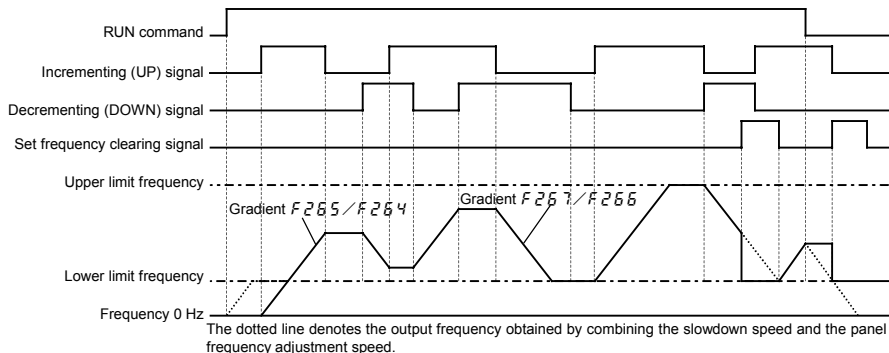

Note: If the operation frequency is set to the lower limit frequency, it will increase from 0Hz when power is turned on for the first time after the setting, and therefore the output frequency will not rise until the operation frequency reaches the lower limit frequency. (Operation at the lower limit frequency)  
 In this case, the time required for the operation frequency to reach the lower limit frequency can be shortened by setting  $F\checkmark$  to the lower limit frequency. Frequency setting values does not change when command is nothing.

### ■ Adjustment with pulse signals (Parameter-setting example 2)

Set parameters as follows to adjust the frequency in steps of one pulse:

$F\checkmark$ ,  $F\checkmark$  ≤ Pulse On time

$F\checkmark$ ,  $F\checkmark$  = Frequency obtained with each pulse

\* The inverter does not respond to any pulses with an ON time shorter than that set with  $F\checkmark$  or  $F\checkmark$ . 12ms or more of clearing signal is allowed.

## &lt;&lt;Sample sequence diagram 2: Adjustment with pulse signals&gt;&gt;

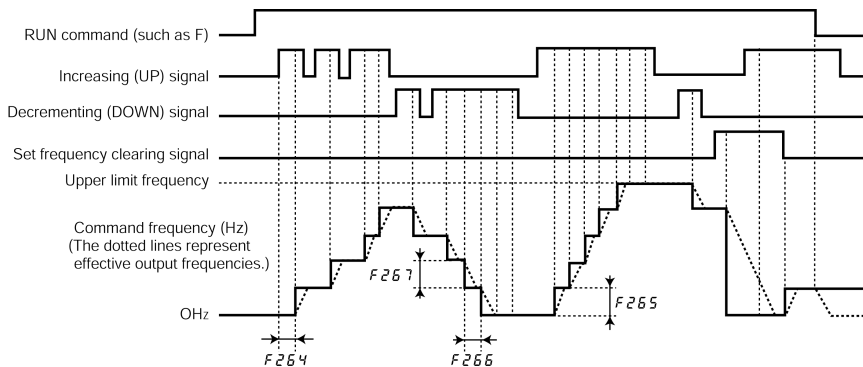

#### 6 ■ If two signals are impressed simultaneously

- If a clear signal and an up or down signal are impressed simultaneously, priority will be given to the clear signal.
- If up and down signals are impressed simultaneously, The frequency will change at the specified up or down rate.

#### ■ About the setting of the initial up/down frequency

To adjust the frequency starting at a specified frequency other than 0.0 Hz (default initial frequency) after turning on the inverter, specify the desired frequency using  $F26B$  (initial up/down frequency).

#### ■ About the change of the initial up/down frequency

To make the inverter automatically save the frequency immediately before it is turned off and start operation at that frequency next time power is turned on, set  $F269$  (change of initial up/down frequency) to 1 (which changes the setting of  $F26B$  when power is turned off). Keep in mind that the setting of  $F26B$  is changed each time power is turned off.

#### ■ Frequency adjustment range

The frequency can be set from 0.0Hz to  $FH$  (Maximum frequency). The lower-limit frequency will be set as soon as the set frequency clearing function (function number 43, 44) is entered from the input terminal.

#### ■ Minimum unit of frequency adjustment

If  $F702$  (Frequency free unit magnification) is set to 1.00, the output frequency can be adjusted in steps of 0.01Hz.

## 6.5.4 Fine adjustment of frequency setting signal

**F470**: VIA input bias

**F471**: VIA input gain

**F472**: VIB input bias

**F473**: VIB input gain

- Function

These parameters are used to fine adjust the relation between the frequency setting signal input through the analog input terminals VIA and VIB and the output frequency.

Use these parameters to make fine adjustments after making rough adjustments using the parameters *F201* to *F213*.

The figure below shows the characteristic of the frequency setting signal input through the VIA and VIB terminals and that of the output frequency.

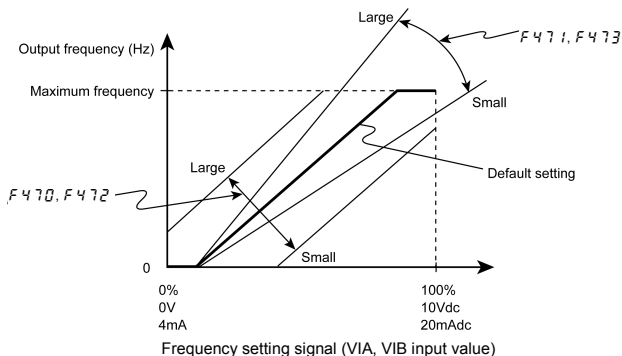

- \* Bias adjustment of VIA and VIB input terminals (*F470* and *F472*)

To give leeway, the inverter is factory-adjusted by default so that it will not produce an output until a certain amount of voltage is applied to the VIA and VIB input terminals. If you want to reduce the leeway, set *F470* or *F472* to a larger value. Note that specifying a too large value may cause an output frequency to be output, even though the operation frequency is 0 (zero) Hz.

- \* Gain adjustment of VIA and VIB input terminals (*F471* and *F473*)

The inverter is factory-adjusted by default so that the operation frequency can reach the maximum frequency, even though the voltage and current to the VIA and VIB input terminals are below the maximum levels. If you want to adjust the inverter so that it will output the maximum frequency at the maximum voltage and current, set *F471* or *F473* to a smaller value. Note that specifying a too small value may cause the operation frequency not to reach the maximum frequency, even though the maximum voltage and current are applied.

## 6.6 Operation frequency

### 6.6.1 Starting frequency

#### $F240$ : Starting frequency setting

- Function  
The frequency set with  $F240$  is put out as soon as operation is started. Use the  $F240$  parameter when a delay in response of starting torque according to the acceleration/deceleration time is probably affecting operation. Setting the starting frequency to a value from 0.5 to 3Hz is recommended. The occurrence of an overcurrent can be suppressed by setting this frequency below the rated slippage of the motor.

#### [Parameter setting]

Title	Function	Adjustment range	Default setting
$F240$	Starting frequency setting	0.5-10.0 (Hz)	0.5

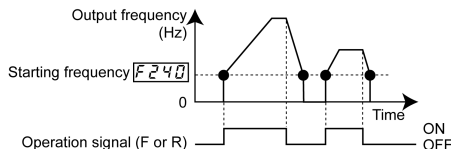

### 6.6.2 Run/stop control with frequency setting signals

#### $F241$ : Operation starting frequency

#### $F242$ : Operation starting frequency hysteresis

- Function  
The Run/stop of operation can be controlled simply with frequency setting signals.

#### [Parameter setting]

Title	Function	Adjustment range	Default setting
$F241$	Operation starting frequency	0.0- $F_H$ (Hz)	0.0
$F242$	Operation starting frequency hysteresis	0.0- $F_H$ (Hz)	0.0

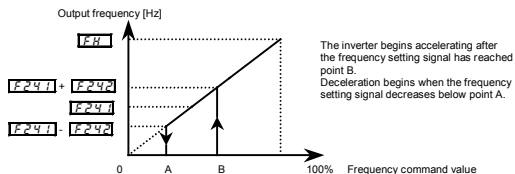

## 6.7 DC braking

### 6.7.1 DC braking

**F250**: DC braking starting frequency

**F251**: DC braking current

**F252**: DC braking time

- Function  
A large braking torque can be obtained by applying a direct current to the motor. These parameters set the direct current to be applied to the motor, the application time and the starting frequency.

[Parameter setting]

Title	Function	Adjustment range	Default setting
<b>F250</b>	DC braking starting frequency	0.0- $F_H$ (Hz)	0.0
<b>F251</b>	DC braking current	0-100 (%) / (A)	50
<b>F252</b>	DC braking time	0.0- 20.0 (sec)	1.0

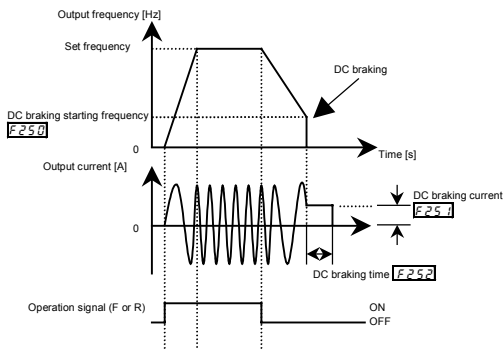

Note 1: During DC braking, the overload protection sensitivity of the inverter increases. The DC braking current may be adjusted automatically to prevent tripping.

Note 2: During DC braking, the carrier frequency is 6kHz irrespective of the setting of parameter **F300** (PWM carrier frequency).

## 6.8 Auto-stop in case of lower-limit frequency continuous operation

### 6.8.1 Auto-stop in case of lower-limit frequency continuous operation

**F256**: Auto-stop in case of lower-limit frequency continuous operation

**F391**: Hysteresis for LL stop operation

**F392**: Restart deviation for LL stop operation

**F393**: Restart feedback for LL stop operation

- Function

If operation is carried out continuously at a frequency command below the lower-limit frequency ( $L_L$ ) for the period of time set with **F256**, the inverter will automatically slow down the motor to a stop. At that time, " $L_L P$ " is displayed (alternately) on the operation panel.

This function will be canceled if a frequency command above the lower-limit frequency ( $L_L$ ) + **F391** Hz.

PID control selected-> The stop of this function will be canceled by deviation and feedback when **F392** and **F393** is setting.

[Parameter setting]

Title	Function	Adjustment range	Default setting
<b>F256</b>	Auto-stop in case of lower-limit frequency continuous operation time	0.0: Disabled 0.1-600.0 (s)	0.0
<b>F391</b>	Hysteresis for LL stop operation	0.0- $F_H$	0.2
<b>F392</b>	Restart deviation for LL stop operation	0.0- $F_H$	0.0
<b>F393</b>	Restart feedback for LL stop operation	0.0- $F_H$	0.0

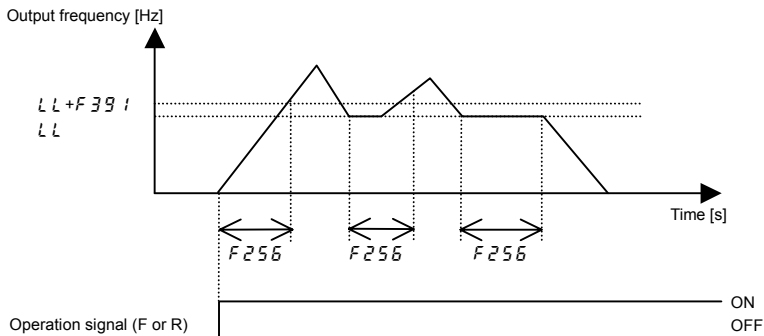

Note: This function is enabled even at the start of operation and during switching between forward and reverse run.

6

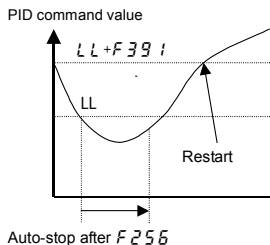

It functions when it is not PID control.

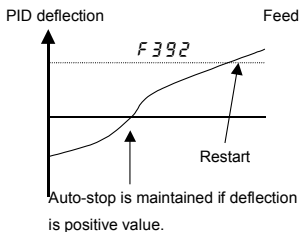

It functions when it is PID control.

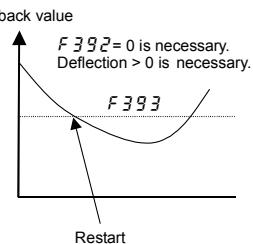

## 6.9 Jump frequency - jumping resonant frequencies

**F270**: Jump frequency 1

**F271**: Jumping width 1

**F272**: Jump frequency 2

**F273**: Jumping width 2

**F274**: Jump frequency 3

**F275**: Jumping width 3

- Function

Resonance due to the natural frequency of the mechanical system can be avoided by jumping the resonant frequency during operation. During jumping, hysteresis characteristics with respect to the jump frequency are given to the motor.

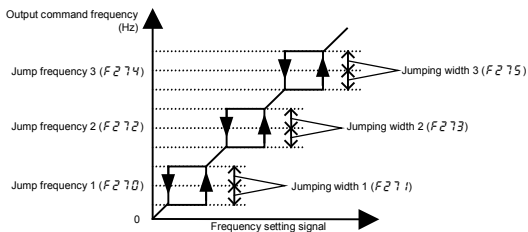

[Parameter setting]

Title	Function	Adjustment range	Default setting
<b>F270</b>	Jump frequency 1	0.0- <i>FH</i> (Hz)	0.0
<b>F271</b>	Jumping width 1	0.0-30.0 (Hz)	0.0
<b>F272</b>	Jump frequency 2	0.0- <i>FH</i> (Hz)	0.0
<b>F273</b>	Jumping width 2	0.0-30.0 (Hz)	0.0
<b>F274</b>	Jump frequency 3	0.0- <i>FH</i> (Hz)	0.0
<b>F275</b>	Jumping width 3	0.0-30.0 (Hz)	0.0

- ★ Do not set the jump parameters, if multiple jump frequency setting width overlap.
- ★ During acceleration or deceleration, the jumping function is disabled for the operation frequency.



## 6.10 Bumpless operation

### F295: Bumpless operation selection

- Function  
When switching from Remote mode to Local mode using  key, the status of start and stop, and operating frequency at Remote mode are moved to Local mode.  
By contraries, when switching from Local mode to Remote mode, they are not moved to Remote mode.

[Parameter setting]

Title	Function	Adjustment range	Default setting
F295	Bumpless operation selection	0: Disabled 1: Enabled	1

Example : Remote mode (  $\overline{L} \overline{R} \overline{D} \overline{D}$  (Terminal board))

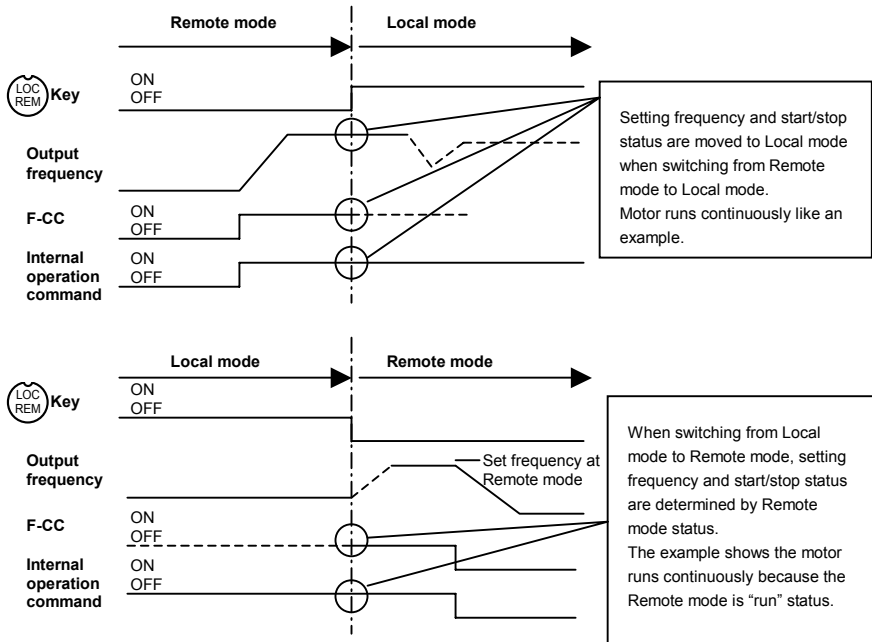

To prevent from moving the setting frequency and start/stop status of Remote mode to Local mode, the F295 is set to "0" (Disabled). In this case,  key is effective only while stopping.

## 6.11 PWM carrier frequency

**F300**: PWM carrier frequency

**F312**: Random mode

**F316**: Carrier frequency control mode selection

- Function

- 1) The **F300** parameter allows the tone of the magnetic noise from the motor to be changed by switching the PWM carrier frequency. This parameter is also effective in preventing the motor from resonating with its load machine or its fan cover.
- 2) In addition, the **F300** parameter reduces the electromagnetic noise generated by the inverter. Reduce the carrier frequency to reduce electromagnetic noise. Note: Although the electromagnetic noise level is reduced, the acoustic noise of the motor is increased.
- 3) The random mode reduces motor electromagnetic noise by changing the pattern of the reduced carrier frequency.

[Parameter setting]

Title	Function	Adjustment range	Default setting
<b>F300</b>	PWM carrier frequency	6.0-16.0 (kHz) (*)	12.0 or 8.0 Depending on model (⇒ See page K-14)
<b>F312</b>	Random mode	0: Disabled, 1: Enabled	0
<b>F316</b>	Carrier frequency control mode selection	0: Carrier frequency not reduced automatically 1: Carrier frequency reduced automatically 2: Carrier frequency not reduced automatically Support for 400V models 3: Carrier frequency reduced automatically Support for 400V models.	1

\* Reduction of rated current will be required if the PWM carrier frequency is modified for each applicable motor model. Refer to the following figure.

\* When the PWM carrier frequency is set high, selecting "Carrier frequency not reduced automatically" causes the inverter to be tripped more easily than selecting "Carrier frequency reduced automatically."



[400V Class for IP20]

Output current **0.4-0.75kW**

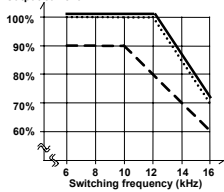

**1.5kW**

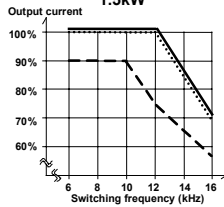

**2.2kW**

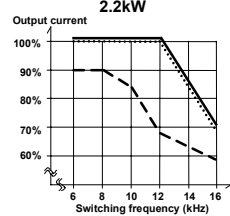

**4kW**

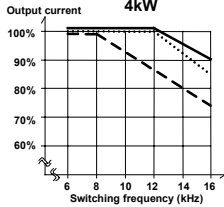

**5.5kW**

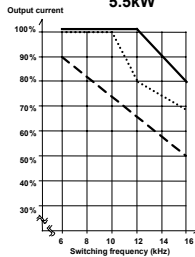

**7.5kW**

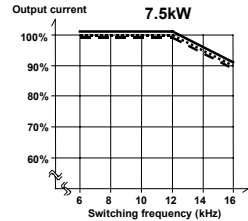

**11kW**

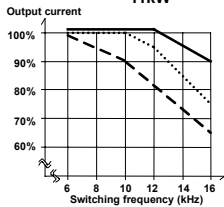

**15kW**

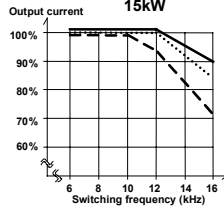

**18.5kW**

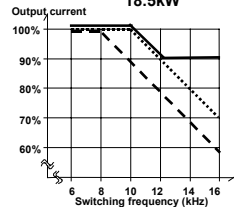

**22kW**

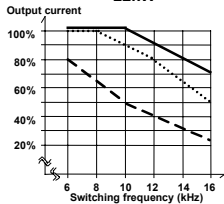

**30kW**

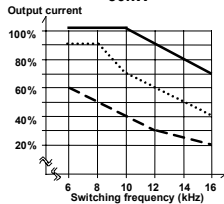

- 40degC ambient
- ..... 50degC ambient
- - - 60degC ambient

400V Class for IP20]

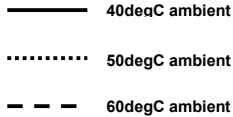
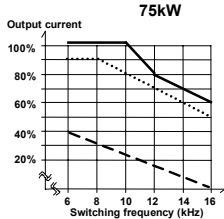
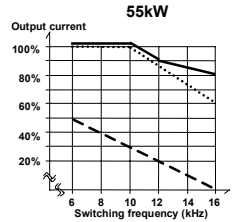
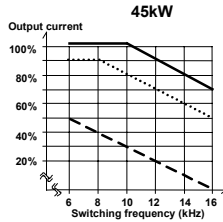
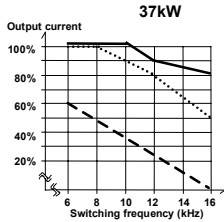

- \* The currents in the above figure are used as the basis to make calculations for inverter overload trip ( $\overline{OL}$ ).
- \* If  $F315$  is set to 0 or 2,  $\overline{OL}$  trip will occur when the current increases and reaches the level above which the carrier frequency is decreased automatically.
- \* Random control is exercised when the motor is operated in a low-frequency range where it produces annoying magnetic noise.  
If the carrier frequency ( $F300$ ) is set above 7.1 kHz, the random control function will not be performed, because the level of motor magnetic noise is low at high frequencies.
- \* When the carrier frequency control mode selection ( $F315$ ) is set to 2 or 3, the carrier frequency ( $F300$ ) should be set preferably 6 kHz. Otherwise the output voltage may drop.

## 6.12 Trip-less intensification

### 6.12.1 Auto-restart (Restart of coasting motor)

**F301**: Auto-restart control selection



Caution



Mandatory

- Stand clear of motors and mechanical equipment  
If the motor stops due to a momentary power failure, the equipment will start suddenly when power is restored. This could result in unexpected injury.
- Attach warnings about sudden restart after a momentary power failure on inverters, motors and equipment for prevention of accidents in advance.

• Function

The **F301** parameter detects the rotating speed and rotational direction of the motor during coasting in the event of momentary power failure, and then after power has been restored, restarts the motor smoothly (motor speed search function). This parameter also allows commercial power operation to be switched to inverter operation without stopping the motor.

During operation, "r r 4" is displayed.

Title	Function	Adjustment range	Default setting
<b>F301</b>	Auto-restart control selection	0: Disabled 1: At auto-restart after momentary stop 2: When turning ST-CC on or off 3: At auto-restart or when turning ST-CC on or off 4: At start-up	0

\* If the motor is restarted in retry mode, this function will operate, regardless of the setting of this parameter.

#### 1) Auto-restart after momentary power failure (Auto-restart function)

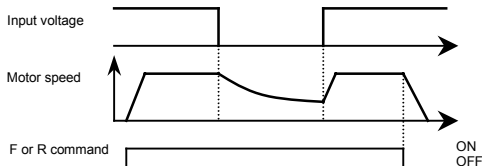

★ Setting **F301** to 1, (3): This function operates after power has been restored following detection of an undervoltage by the main circuits and control power.

## 2) Restarting motor during coasting (Motor speed search function)

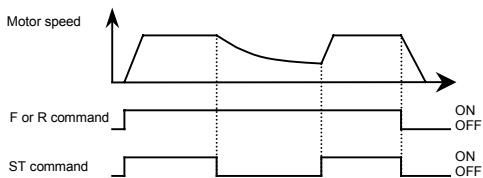

- ★ Setting  $F301$  to 2 or 3: This function operates after the ST terminal connection has been OFF first and then ON again.

Note: The terminal function ST needs to be assigned to an input terminal, using the parameters  $F111$ ~ $F113$ ,  $F118$ .

## 3) Motor speed search at starting

When  $F301$  is set to 4, a motor speed search is performed each time operation is started.

This function is useful especially when the motor is not operated by the inverter but it is running because of external force.

### Warning!!

- At restart, it takes about 300 ms for the inverter to check to see the number of revolutions of the motor.  
For this reason, the start-up takes more time than usual.
- Use this function when operating a system with one motor connected to one inverter.  
This function may not operate properly in a system configuration with multiple motors connected to one inverter.

## 6.12.2 Instantaneous power failure coast stop selection

### **F302**: Instantaneous power failure coast stop selection

- Function

Coast stop in the event of momentary power failure: If a momentary power failure occurs during operation, the inverter coast stops forcibly. When operation is stopped, the message "S E P" is displayed (alternately) on the operation panel.

After the forced coast stop, the inverter remains static until you put off the operation command momentarily.

#### [Parameter setting]

Title	Function	Adjustment range	Default setting
F302	Instantaneous power failure coast stop selection	0: Disabled 1: - (Do not select) 2: Coast stop	0

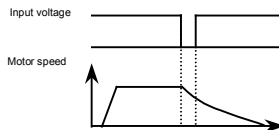

[If momentary power failure occurs]





## 6.12.3 Retry function

**F303**: Retry selection (Selecting the number of times)

 Caution	
 Mandatory	<ul style="list-style-type: none"> <li>Do not go near the motor in alarm-stop status when the retry function is selected. The motor may suddenly restart, which could result in injury.</li> <li>Take measures for safety, e.g. attach a cover to the motor, to prevent accidents if the motor suddenly restarts.</li> </ul>

- Function  
This parameter resets the inverter automatically when the inverter gives an alarm. During the retry mode, the motor speed search function operated automatically as required and thus allows smooth motor restarting.

[Parameter setting]

Title	Function	Adjustment range	Default setting
<b>F303</b>	Retry selection (number of times)	0: Disabled, 1-10 times	0

The likely causes of tripping and the corresponding retry processes are listed below.

Cause of tripping	Retry process	Canceling conditions
Momentary power failure Overcurrent Overvoltage Overload Overheating	Up to 10 times in succession 1st retry: About 1 sec after tripping 2nd retry: About 2 sec after tripping 3rd retry: About 3 sec after tripping : 10th retry: About 10 sec after tripping	The retry function will be canceled at once if tripping is caused by an unusual event other than: momentary power failure, overcurrent, overvoltage or overload.  This function will also be canceled if retrying is not successful within the specified number of times.

★ The retry function is disabled in the following unusual events:

- OC R** : Arm overcurrent at start-up
- OC L** : Overcurrent on the load side at start-up
- EPHO** : Output phase failure
- OH 2** : External thermal trip
- OE** : Overtorque trip
- E** : External trip stop
- UC** : Small-current operation trip
- UP 1** : Undervoltage trip (main circuit)
- EF 2** : Ground fault trip
- EPH 1** : Input phase failure
- EtYP** : Inverter type error
- Err 2** : Main unit RAM fault
- Err 3** : Main unit ROM fault
- Err 4** : CPU fault trip
- Err 5** : Remote control error
- Err 7** : Current detector fault
- Err 8** : Control circuit board format error
- E E P 1** : EEPROM fault 1
- E E P 2** : EEPROM fault 2
- E E P 3** : EEPROM fault 3
- Et n 1** : Auto-tuning error
- E - 18** : VIA input detection error
- E - 19** : Main unit CPU communication error
- E - 20** : Excessive torque boost
- E - 2 1** : CPU fault 2

- ★ In the event of tripping caused by  $OP$ , the retry function works only once even though  $F303=0$ .  
 $F303$  is activated, the retry function works according to the specified number of times.
- ★ Protective operation detection relay signals (FLA, FLB, FLC terminal signals) are not sent during use of the retry function. (Default setting)
- ★ To allow a signal to be sent to the protective action detection relay (FLA, B and C terminals) even during the retry process, assign the function 36 or 37 to  $F132$ .
- ★ A virtual cooling time is provided for overload tripping ( $OL1, OL2$ ).  
In this case, the retry function operates after the virtual cooling time and retry time.
- ★ In the event of tripping caused by an overvoltage ( $OP1 - OP3$ ), the retry function will not be activated until the voltage in the DC section comes down to a normal level.
- ★ In the event of tripping caused by overheating ( $OH$ ), the retry function will not be activated until the temperature in the inverter comes down low enough for it to restart operation.
- ★ The retry function does not work even though  $F303$  is activated in case of powering-up with  $F602=1$  after trip.
- ★ During retrying, the blinking display will alternate between  $rErY$  and the monitor display specified by status monitor display mode selection parameter  $F710$ .
- ★ The number of retries will be cleared if the inverter is not tripped for the specified period of time after a successful retry.  
"A successful retry" means that the inverter output frequency reaches the command frequency without causing the inverter to re-trip.

## 6.12.4 Avoiding overvoltage tripping

**F305**: Overvoltage limit operation

**F626**: Overvoltage stall protection level

- Function  
These parameters are used to keep the output frequency constant or increase it to prevent overvoltage tripping in case the voltage in the DC section rises during deceleration or varying speed operation. The deceleration time during overvoltage limit operation may increase above the designated time.

Overvoltage limit operation level

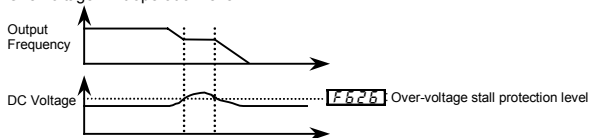

[Parameter setting]

Title	Function	Adjustment range	Default setting
<b>F305</b>	Overvoltage limit operation (Slowdown stop mode selection)	0: Enabled 1: Disabled 2: Enabled (Quick deceleration) 3: Enabled (Dynamic quick deceleration)	2
<b>F626</b>	Overvoltage limit operation level	100-150%	140

- ★ If **F305** is set to 2 (quick deceleration), the inverter will increase the voltage to the motor (over-excitation control) to increase the amount of energy consumed by the motor when the voltage reaches the overvoltage protection level, and therefore the motor can be decelerated more quickly than normal deceleration.
- ★ If **F305** is set to 3 (dynamic quick deceleration), the inverter will increase the voltage to the motor (over-excitation control) to increase the amount of energy consumed by the motor as soon as the motor begins to slow down, and therefore the motor can be decelerated still more quickly than quick deceleration.

## 6.12.5 Output voltage adjustment/Supply voltage correction

**ωLω**: Base frequency voltage 1

**F307**: Supply voltage correction (output voltage adjustment)

- Function

**Base frequency voltage1**

The **F307** parameter adjusts the voltage corresponding to the base frequency **ωLω** so that no voltage exceeding the **ωLω** set value is put out. (This function is enabled only when **F307** is set to either "0" or "1".)

**Supply voltage correction**

The **F307** parameter maintains a constant V/F ratio, even when the input voltage decreases. The torque during low-speed operation is prevented from decreasing.

Supply voltage correction: Maintains a constant V/F ratio, even when the input voltage fluctuates.

Limitation of output voltage: Limits the voltage at frequencies exceeding the base frequency. Applied when operating a special motor with low induced voltage.

[Parameter setting]

Title	Function	Adjustment range	Default setting
<b>ωLω</b>	Base frequency voltage1	50-330 (V) : 200V class 50-660 (V) : 400V class	230 (WP/WN type) 400 (WP type) 460 (WN type)
<b>F307</b>	Supply voltage correction (limitation of output voltage)	0: Supply voltage uncorrected, output voltage limited 1: Supply voltage corrected, output voltage limited 2: Supply voltage uncorrected, output voltage unlimited 3: Supply voltage corrected, output voltage unlimited	3

★ If **F307** is set to "0" or "2", the output voltage will change in proportion to the input voltage.

★ Even if the base frequency voltage (**ωLω** parameter) is set above the input voltage, the output voltage will not exceed the input voltage.

★ The rate of voltage to frequency can be adjusted according to the rated motor capacity. For example, setting **F307** to "0" or "1" prevents the output voltage from increasing, even if the input voltage changes when operation frequency exceeds the base frequency.

★ When the V/F control mode selection parameter (**P1**) is set to any number between 2 and 5, the supply voltage is corrected regardless of the setting of **F307**.

[0: Supply voltage uncorrected, output voltage limited]

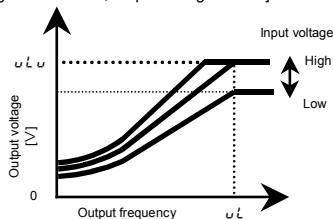

\* The above applies when V/F control mode selection parameter  $P_{\omega L}$  is set to "0" or "1".  
 \* The output voltage can be prevented from exceeding the input voltage.

[1: Supply voltage corrected, output voltage limited]

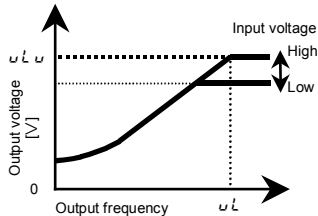

[2: Supply voltage uncorrected, output voltage unlimited]

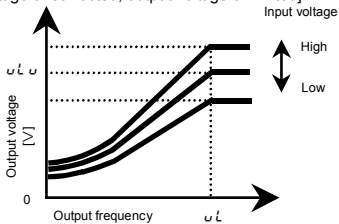

\* The above applies when V/F control mode selection parameter  $P_{\omega L}$  is set to "0" or "1".  
 \* The output voltage can be prevented from exceeding the input voltage.

[3: Supply voltage corrected, output voltage unlimited]

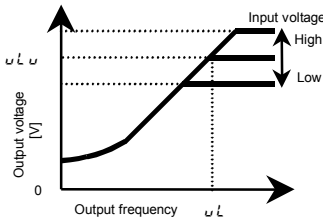

\* Even if  $\omega L$  is set for an output voltage lower than the input voltage, the output voltage will exceed the voltage adjusted by  $\omega L$  when the output frequency is higher than the base frequency  $1/\omega L$ .

6

## 6.12.6 Canceling the operation command

### **F311**: Reverse-run prohibition

- Function  
 This function prevents the motor from running in the forward or reverse direction when it receives the wrong operation signal.

[Parameter setting]

Title	Function	Adjustment range	Default setting
F311	Reverse-run prohibition	0: Forward/reverse run permitted 1: Reverse run prohibited 2: Forward run prohibited	0

## 6.13 Droop control

**F320**: Droop gain

**F323**: Droop insensitive torque band

- Function  
The motor is allowed to "slip" according to the load torque current. Using these parameters, the insensitive torque band and the gain can be adjusted.

[Parameter setting]

Title	Function	Adjustment range	Default setting
<b>F320</b>	Droop gain	0-100%	0%
<b>F323</b>	Droop insensitive torque band	0-100%	10%

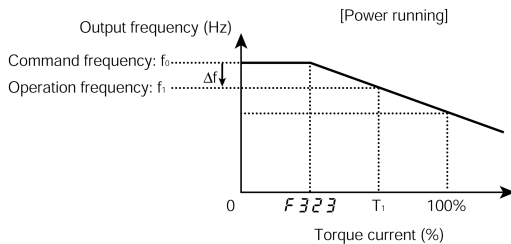

- ★ The droop control function refers to the function of operating the power-running motor at operating frequency  $f_1$  (Hz) that is lower than command frequency  $f_0$  (Hz) by droop frequency  $\Delta f$  (Hz) when the torque current is  $T_1$  (%). (See the above figure.)
- The droop frequency  $\Delta f$  can be calculated, using the following expression.  
Droop frequency  $\Delta f$  (Hz)=base frequency  $\omega \times F \times T_1 - F \times T_1$
- When the torque current is above the specified droop insensitive torque band ( $F \times T_1$ ), the frequency is reduced during power running or increased during regenerative braking. The above figure shows an example of the operating frequency during power running. During regenerative braking, control is performed in such a way as to increase the frequency.
- The droop function is activated above the torque current set with  $F \times T_1$ .
- The amount of droop frequency  $\Delta f$  varies depending on the amount of torque current  $T_1$ .

Note: If the base frequency  $\omega$  exceeds 100Hz, count it as 100Hz.

Control is exercised between the starting frequency ( $F \times T_1$ ) and the maximum frequency ( $F H$ ).

[An example of calculation]

Parameter setting: Base frequency  $\omega = 60$  (Hz), droop gain  $F \times T_1 = 10$  (%)

Droop insensitive torque band  $F \times T_1 = 30$  (%)

Droop frequency  $\Delta f$  (Hz) and operating frequency  $f_1$  when command frequency  $f_0$  is 50 (Hz) and torque current  $T_1$  is 100 (%) are as follows.

$$\begin{aligned} \text{Droop frequency } \Delta f \text{ (Hz)} &= \omega \times F \times T_1 - F \times T_1 \\ &= 60 \text{ (Hz)} \times 10 \text{ (\%)} - (100 \text{ (\%)} - 30 \text{ (\%)}) \\ &= 4.2 \text{ (Hz)} \end{aligned}$$

$$\text{Operation frequency } f_1 \text{ (Hz)} = f_0 - \Delta f = 50 \text{ (Hz)} - 4.2 \text{ (Hz)} = 45.8 \text{ (Hz)}$$

## 6.14 Conducting PID control

**F359**: PID control waiting time

**F360**: PID control

**F362**: Proportional gain

**F363**: Integral gain

**F366**: Differential gain

**F380**: PID forward / reverse characteristic selection

- Function  
Using feedback signals (4 to 20mA, 0 to 10V) from a detector, process control can be exercised, for example, to keep the airflow, amount of flow or pressure constant.

[Parameter setting]

Title	Function	Adjustment range	Default setting
<b>F359</b>	PID control waiting time	0-2400 [s]	0
<b>F360</b>	PID control	0: Disabled 1: Enabled (Feedback: VIA) 2: Enabled (Feedback: VIB)	0
<b>F362</b>	Proportional gain	0.01-100.0	0.30
<b>F363</b>	Integral gain	0.01-100.0	0.20
<b>F366</b>	Differential gain	0.00-2.55	0.00
<b>F380</b>	PID forward / reverse characteristic selection	0:Forward (Standard) 1:Reverse	0

### 1) External connection

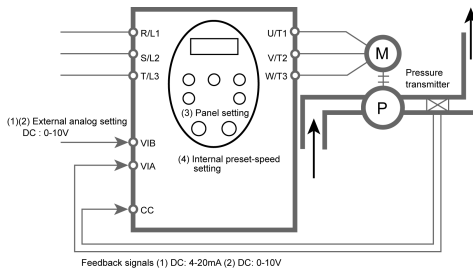



## 2) Types of PID control interfaces

Process quantity input data (frequency) and feedback input data can be combined as follows for the PID control of the VF-FS1:

Process quantity input data (frequency setting)		Feedback input data
Setting method	Frequency setting mode selection <i>F 00 d / F 20 7</i>	PID control <i>F 360</i>
(1) External analog setting VIA (DC: 4-20mA / 0-10V)	1	1: External analog input VIA (DC:4-20mA / DC:0-10V)
(2) External analog setting VIB (DC: 0-10V)	2	2: External analog input VIB (DC:0-10V)
(3) Panel input setting Internal preset-speed setting	3	
(4) RS485 communication	4	
(5) UP/DOWN from external contact	5	
(6) Internal preset-speed setting	-( <i>F 00 d=0</i> )	

Note 1: About the setting of *F 00 d* and *F 20 7*: Do not select the same terminal that is used feedback terminal (VIA or VIB).

Note 2: When using VIA terminal, set *F 130* or *F 132* respectively to 52 or 53 to put out signals to RY-RC or FLA-FLB-FLC.

When using VIB terminal, set *F 130* or *F 132* respectively to 60 or 61 to put out signals to RY-RC or FLA-FLB-FLC.

You can also specify a frequency agreement detection range (*F 16 7*).

⇒ For more information, see section 6.3.5.

## 3) Setting PID control

Set "1" or "2" in the extended parameter *F 360* (PID control).

- Set parameters *R L L* (acceleration time), and *d E L* (deceleration time) to the system fitting values.
- To limit the output frequency, set parameters *U L* (upper limit frequency) and *L L* (lower limit frequency). If process quantities are set from the operation panel, however, the process quantity setting range will be limited by the settings of *U L* and *L L*.
- Input terminal function "PID control prohibited" (function No.14) can changing PID control or open-loop control. Also Input terminal function "PID control integral value clear" (function No.65) can use.
- By the set the *F 380* or Input terminal function "PID forward/reverse switching" (function No.72), PID control is reverse. When a reverse-characteristic is selected at the same time with the parameter and the terminal, it becomes a forward characteristic.

#### 4) Adjusting the PID control gain level

Adjust the PID control gain level according to the process quantities, the feedback signals and the object to be controlled.

The following parameters are provided for gain adjustment:

Parameter	Setting range	Default setting
F 3 6 2 (P-gain)	0.01-100.0	0.30
F 3 6 3 (I-gain)	0.01-100.0	0.20
F 3 6 5 (D-gain)	0.00-2.55	0.00

##### F 3 6 2 (P-gain adjustment parameter)

This parameter adjusts the proportional gain level during PID control. A correction value proportional to the particular deviation (the difference between the set frequency and the feedback value) is obtained by multiplying this deviation by the parameter setting.

A larger P-gain adjustment value gives faster response. Too large an adjustment value, however, results in an unstable event such as hunting.

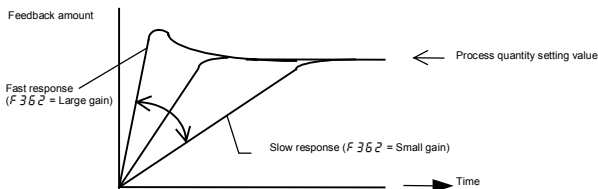

##### F 3 6 3 (I-gain adjustment parameter)

This parameter adjusts the integral gain level during PID control. Any deviations remaining unremoved during proportional action are cleared to zero (residual deviation offset function).

A larger I-gain adjustment value reduces residual deviations. Too large an adjustment value, however, results in an unstable event such as hunting.

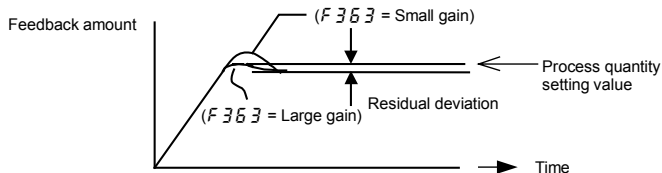

- ★ If one of input terminals is assigned input terminal function 65 (PID control integral value clear), integral value is always 0 (zero) during the input terminal on.

### F356 (D-gain adjustment parameter)

This parameter adjusts the differential gain level during PID control. This gain increases the speed of response to a rapid change in deviation (difference between the frequency setting and the amount of feedback).

Note that setting the gain more than necessary may cause great fluctuations in output frequency, and thus operation to become unstable.

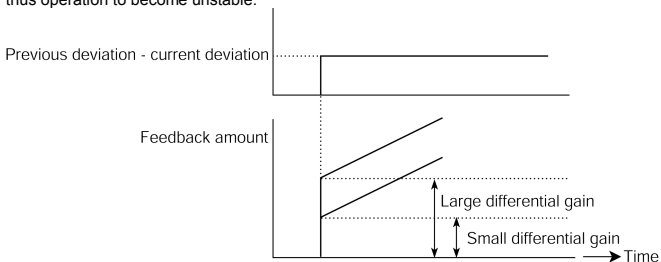

### 5) Adjusting analog command voltages

To use external analog setting (VIA or VIB) or feedback input (VIA or VIB), perform voltage-scaling adjustments (input point setting) as required. ⇒ See section 6.5.2 for further details.

If the feedback input data is too small, voltage-scaling adjustment data can also be used for gain adjustment.

Example of VIB terminal setting

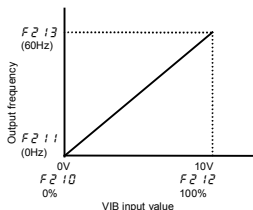

Example of VIA terminal setting (voltage input)

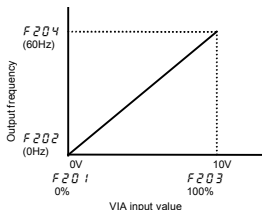

Example of VIA terminal setting (current input)

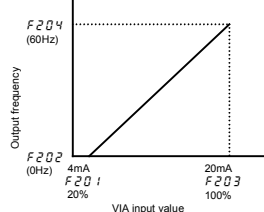

### 6) Setting the time elapsed before PID control starts

You can specify a waiting time for PID control to prevent the inverter from starting PID control before the control system becomes stable, for example, after start-up.

The inverter ignores feedback input signals, carries out operation at the frequency determined by the amount of processing for the period of time specified with F359 and enters the PID control mode after a lapse of the specified time.

## 6.15 Setting motor constants

### 6.15.1 Setting motor constants 1

**F400**: Auto-tuning

**F401**: Slip frequency gain

**F402**: Automatic torque boost value

**F415**: Motor rated current

**F416**: Motor no-load current

**F417**: Motor rated speed

**F418**: Speed control response coefficient

**F419**: Speed control stable coefficient

To use vector control, automatic torque boost and automatic energy saving, motor constant setting (motor tuning) is required. The following two methods are available to set motor constants.

- 1) Setting V/F control mode selection ( $P\text{E}$ ) and auto-tuning ( $F\ 400$ ) independently
- 2) Combining the V/F control mode selection ( $P\text{E}$ ) and manual tuning

- ★ Check to be sure that the setting of the parameter  $\omega\ \omega$  and that of the parameter  $\omega\ \omega\ \omega$  agree with the base frequency (rated rotational speed) and base frequency voltage (rated voltage) of the motor to be operated, respectively. If not, set the parameters correctly.
- ★ When using the inverter to control the operation of a motor smaller in capacity by one grade or more, be sure to set the motor rated current setting parameter ( $F\ 415$ ) properly.
- ★ Vector control may not operate properly if the motor capacity differs from the applicable rated capacity of the inverter by more than two grades.

If current waveforms oscillate during operation, increase the speed control stability factor ( $F\ 419$ ). This is effective in suppressing oscillation.

### [Selection 1: Setting vector control and auto-tuning independently]

This method sets energy-saving, sensorless vector control, automatic torque boost, and auto-tuning independently.

Specify the control mode selection parameter ( $P\bar{L}$ ) and then set auto-tuning.

Set the auto-tuning parameter  $F400$  to  $2$   
(Auto-tuning enabled)

[Parameter setting]

Title	Function	Adjustment range	Default setting
$F400$	Auto-tuning	0: Auto-tuning disabled (use of internal parameters) 1: Application of individual settings of $F402$ (after execution: 0) 2: Auto-tuning enabled (after execution: 0)	0

(1) At least, set the following parameters, as specified on the nameplate of the motor.

Title	Function	Adjustment range
$\omega L$	Base frequency 1	25.0-200.0 (Hz)
$\omega L \nu$	Base frequency voltage 1	50-330 (V) : 200V class 50-660 (V) : 400V class
$F415$	Motor rated current	0.1-200.0 (A)
$F417$	Motor rated speed	100-15000 ( $\text{min}^{-1}$ )

(2) Set  $F400$  to  $2$  to before the start of operation. Tuning is performed at the start of the motor.

#### ★ Precautions on auto-tuning

- (1) Conduct auto-tuning only after the motor has been connected and operation completely stopped.  
If auto-tuning is conducted immediately after operation stops, the presence of a residual voltage may result in abnormal tuning.
- (2) Voltage is applied to the motor during tuning even though it barely rotates. During tuning, " $R\bar{L}n!$ " is displayed on the operation panel.
- (3) Tuning is performed when the motor starts for the first time after  $F400$  is set to  $2$ .  
Tuning is usually completed within three seconds. If it is aborted, the motor will trip with the display of  $E\bar{L}n!$  and no constants will be set for that motor.
- (4) High-speed motors, high-slip motors or other special motors cannot be auto-tuned. For these motors, perform manual tuning using Selection 2 described below.
- (5) The resulting insufficient motor torque during tuning could create a risk of machine stalling/falling.
- (6) If auto-tuning is impossible or an " $E\bar{L}n!$ " auto-tuning error is displayed, perform manual tuning with Selection 2.
- (7) If the inverter is tripped during auto-tuning because of an output phase failure ( $E\bar{P}H\bar{G}$ ), check if the inverter is connected to the correctly. A check for output phase failures is made during auto-tuning, regardless of the setting of the output phase failure detection mode selection parameter ( $F605$ ).

## [Selection 2: Setting vector control and manual tuning independently]

If an "E<sub>tn</sub>" tuning error is displayed during auto-tuning or when vector control characteristics are to be improved, independent motor constants can be set.

Title	Function	Adjustment range	Default setting
F401	Slip frequency gain	0-150 (%)	50
F402	Automatic torque boost value	0.0-30.0 (%)	Depends on the capacity (⇒ See page K-14)
F415	Motor rated current	0.1-200.0 (A)	
F416	Motor no-load current	10-100 (%)	
F417	Motor rated rotational speed	100-15000 (min <sup>-1</sup> )	
F418	Speed control response coefficient	1-150	40
F419	Speed control stability coefficient	1-100	20

Setting procedure Adjust the following parameters:

**F401**: Set the compensation gain for the slipping of the motor. A higher slip frequency reduces motor slipping correspondingly. After setting **F417**, set **F401** to adjust in detail.

**F402**: Adjust the primary resistive component of the motor. Use the auto-tuning value.

**F415**: Set the rated current of the motor. For the rated current, see the motor's nameplate or test report.

**F416**: Set the ratio of the no-load current of the motor to the rated current. Enter the value in % that is obtained by dividing the no-load current specified in the motor's test report by the rated current.

**F417**: Set the rated rotational speed of the motor. For the rated current, see the motor's nameplate or test report.

- F418**: Using this parameter along with **F419**, adjust the speed of response to the frequency command.  
**F419**: Using this parameter along with **F418**, adjust the speed of response to the frequency command.

\* How to make adjustments according to the moment of inertia of the load

The moment of inertia of the load (including that of the motor shaft) was set at the factory on the assumption that it would be three times as large as that of the motor shaft.

Adjust **F418**, **F419** with the ratio of inertia in case load inertia is different from three times of the motor inertia.

When making the above adjustments, increase or decrease settings in steps of 10% or so while checking how things change.

Note also that, depending on the settings of **F418** and **F419**, the frequency may exceed the upper-limit frequency if the inverter is set so as to accelerate the load in the shortest possible time.

## 6.15.2 Setting motor constants 2 (Details)

**F480**: Exciting current coefficient

**F485**: Stall prevention control coefficient 1

**F492**: Stall prevention control coefficient 2

**F494**: Motor adjustment coefficient

**F495**: Maximam voltage adjustment coefficient

**F496**: Waveform switching adjustment coefficient

\* The following parameters enables you to make adjustments more finely.

Title	Function	Adjustment range	Default setting
<b>F480</b>	Exciting current coefficient	100-130 (%)	100
<b>F485</b>	Stall prevention control coefficient 1	10-250	100
<b>F492</b>	Stall prevention control coefficient 2	50-150	100
<b>F494</b>	Motor adjustment coefficient	0-200	Depends on the capacity
<b>F495</b>	Maximam voltage adjustment coefficient	90-120 (%)	104
<b>F496</b>	Waveform switching adjustment coefficient	0.1-14.0(kHz)	14.0

**F480**: Used to fine adjust the magnetic field increase rate in low-speed range. To increase the torque in low-speed range, specify a larger value for **F480**. Note that this parameter should be adjusted only when enough torque cannot be obtained, even though auto-tuning (**F400=2**) was made after the setting of the parameters **F401** through **F419**. Note also that adjusting this parameter may cause an increase in the no-load current in low-speed range. If the no-load current exceeds the rated current, do not adjust this parameter.

**F485**: Using this parameter along with **F492** adjusts characteristics in a region in which the frequency is above the base frequency (region where the field is weak).

- F 4 9 2*: Using this parameter along with *F 4 8 5* adjusts characteristics in a region in which the frequency is above the base frequency (region where the field is weak).
- \* How to make adjustments in a region (region where magnetic field is weak) above the base frequency
- If a heavy load is applied instantaneously (or transiently), the motor may stall before the load current reaches the current set with the stall prevention level 1 parameter (*F 5 0 1*). In many cases, this kind of stall can be avoided by gradually reducing the setting of *F 4 8 5*.
- A drop in supply voltage may cause fluctuations of the load current or vibration of the motor. In some cases, such phenomena can be eliminated by changing the setting of *F 4 9 2* to between 80 and 90. However, this may cause an increase in load current, so that it is also necessary to adjust the setting of the electronic thermal protective level 1 parameter (*L H r*) properly according to the motor capacity.
- F 4 9 4*: There is no need to adjust this parameter under normal conditions. (Do not change the setting, unless otherwise instructed by Toshiba technical staff)
- F 4 9 5*: Specify a larger value for *F 4 9 5* to secure as high an output voltage as possible in a region (region where magnetic field is weak) above the base frequency. Setting *F 4 9 5* to a larger value may cause the motor to vibrate or gears to squeak. If such a phenomenon occurs, do not adjust this parameter.
- F 4 9 6*: Specify a larger value for *F 4 9 6* if switching from a waveform to another results in a considerable increase in vibration and noise in middle-speed range (region between the start frequency and the base frequency). If no improvement can be made by specifying a larger value, do not adjust this parameter.



## 6.16 Acceleration/deceleration time 2

### 6.16.1 Selecting an acceleration/deceleration pattern

**F502**: Acceleration/deceleration 1 pattern

**F506**: S-pattern lower-limit adjustment amount

**F507**: S-pattern upper-limit adjustment amount

- Function

These parameters allow you to select an acceleration/deceleration pattern that suits the intended use.

Title	Function	Adjustment range	Default setting
<b>F502</b>	Acceleration/ deceleration 1 pattern	0: Linear, 1: S-pattern 1, 2: S-pattern 2	0
<b>F506</b>	S-pattern lower-limit adjustment amount	0-50%	10%
<b>F507</b>	S-pattern upper-limit adjustment amount	0-50%	10%

1) Linear acceleration/deceleration

A general acceleration/ deceleration pattern. This pattern can usually be used.

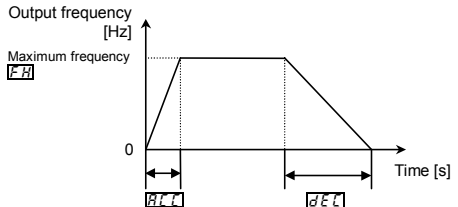

2) S-pattern acceleration/deceleration 1

Select this pattern to accelerate/decelerate the motor rapidly to a high-speed region with an output frequency of 60Hz or more or to minimize the shocks applied during acceleration/deceleration. This pattern is suitable for pneumatic transport machines.

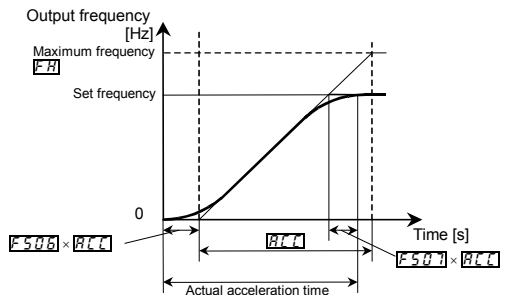

## 3) S-pattern acceleration/deceleration

Select this pattern to obtain slow acceleration in a demagnetizing region with a small motor acceleration torque. This pattern is suitable for high-speed spindle operation.

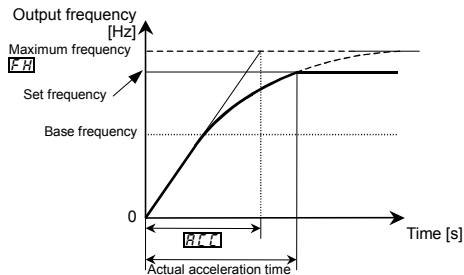

## 6.16.2 Switching acceleration/deceleration time 1 and 2

**F500**: Acceleration time 2

**F501**: Deceleration time 2

**F503**: Acceleration/deceleration 2 pattern

**F504**: Selecting an acceleration/deceleration pattern

**F505**: Acceleration/deceleration 1 and 2 switching frequency

- Function

Two acceleration times and two deceleration times can be specified individually. A method of selection or switching can be selected from among the following:

- 1) Selection by means of parameters
- 2) Switching by changing frequencies
- 3) Switching by means of terminals

Title	Function	Adjustment range	Default setting
<i>F500</i>	Acceleration time 2	0.0-3200 [s]	Depends on the capacity (⇒ See page K-14)
<i>F501</i>	Deceleration time 2	0.0-3200 [s]	Depends on the capacity (⇒ See page K-14)
<i>F504</i>	Selecting an acceleration/deceleration pattern	1: Acc / dec 1 2: Acc / dec 2	1

## 1) Selection using parameters

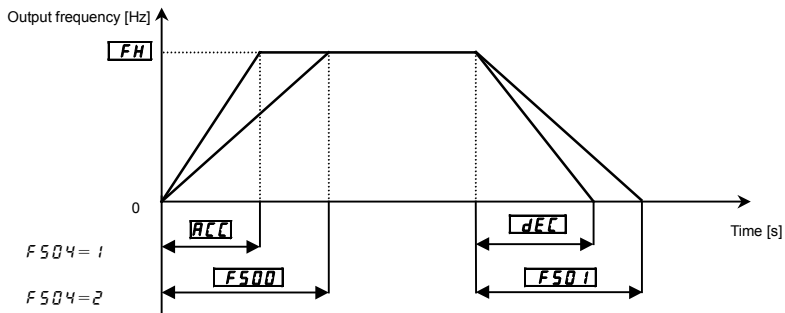

Acceleration/deceleration time 1 is initially set as the default. Acceleration/deceleration time 2 can be selected by changing the setting of the *F504*.

Enabled if  $\text{CN}d=1$  (panel input enabled)

2) Switching by frequencies - Switching the acceleration/deceleration time automatically at the frequency setting of *F505*.

Title	Function	Adjustment range	Default setting
<i>F505</i>	Acceleration/deceleration 1 and 2 switching frequency	0.0-UL	0.0

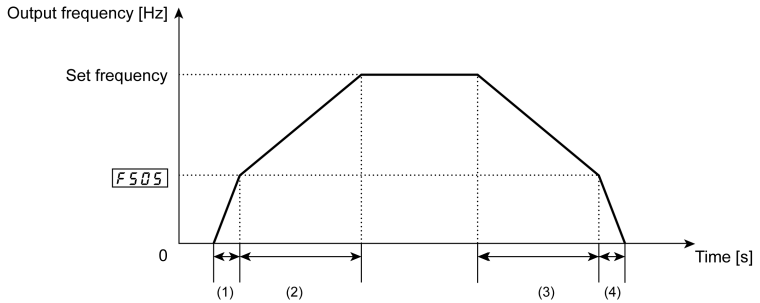

- (1) Acceleration at the gradient corresponding to acceleration time  $R\ C\ C$
- (2) Acceleration at the gradient corresponding to acceleration time  $F\ S\ D\ D$
- (3) Deceleration at the gradient corresponding to deceleration time  $F\ S\ D\ I$
- (4) Deceleration at the gradient corresponding to deceleration time  $d\ E\ C$

3) Switching using external terminals - Switching the acceleration/deceleration time via external terminals

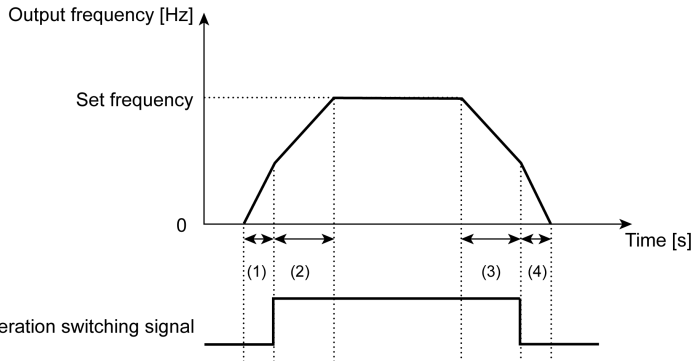

- (1) Acceleration at the gradient corresponding to acceleration time  $R\ C\ C$
- (2) Acceleration at the gradient corresponding to acceleration time  $F\ S\ D\ D$
- (3) Deceleration at the gradient corresponding to deceleration time  $F\ S\ D\ I$
- (4) Deceleration at the gradient corresponding to deceleration time  $d\ E\ C$

- How to set parameters
  - a) Operating method: Terminal input  
Set the operation control mode selection [ *P0d* ] to *0*.
  - b) Use the RES terminal for switching. (Instead, other terminals may be used.)

RES: Acceleration/deceleration switching signal

Title	Function	Adjustment range	Setting value
<i>F113</i>	Input terminal selection 3 (RES)	0-72	5 (the second acceleration/deceleration mode selection)

- Acceleration/ deceleration pattern  
Acceleration/deceleration patterns can be selected individually, using the acceleration/deceleration 1, 2 and 3 parameters.
  - 1) Linear acceleration/deceleration
  - 2) S-pattern acceleration/deceleration 1
  - 3) S-pattern acceleration/deceleration 2

Title	Function	Adjustment range	Default setting
<i>F502</i>	Acceleration/ deceleration 1 pattern	0: Linear 1: S-pattern 1	0
<i>F503</i>	Acceleration/ deceleration 2 pattern	2: S-pattern 2	0

★ Both the settings of the S-pattern lower-limit and upper-limit adjustment parameters (*F506* and *F507*) are applied to any acceleration/deceleration S-pattern.

⇒ For an explanation of acceleration/deceleration patterns, see section 6.16.1.

## 6.17 Protection functions

### 6.17.1 Setting motor electronic thermal protection

***E4r***: Motor electronic thermal protection level 1

***F173***: Motor electronic thermal protection level 2

***F607***: Motor 150%-overload time limit

***F632***: Motor electronic-thermal protection retention selection

- Function  
This parameter allows selection of the appropriate electronic thermal protection characteristics according to the particular rating and characteristics of the motor.

[Parameter setting]

Title	Function	Adjustment range	Default setting
$\epsilon H r$	Motor electronic thermal protection level 1	10-100 (%) / (A)	100
$F 173$	Motor electronic thermal protection level 2	10-100 (%) / (A)	100
$F 607$	Motor 150%-overload time limit	10-2400 (s)	300
$F 632$	Motor electric-thermal protection retention selection	0: Disabled 1: Enabled	0

⇒ For more details, see section 5.12.

Note: The 100% standard value is the rated output current indicated on the nameplate.

## 6.17.2 Setting current stall

$F 601$ : Stall prevention level 1

$F 185$ : Stall prevention level 2



Caution



Prohibited

- Do not set the stall prevention level ( $F 601$ ) extremely low. If the stall prevention level parameter ( $F 601$ ) is set at or below the no-load current of the motor, the stall preventive function will be always active and increase the frequency when it judges that regenerative braking is taking place. Do not set the stall prevention level parameter ( $F 601$ ) below 30% under normal use conditions.

- Function  
This parameter adjusts the output frequency by activating a current stall prevention function against a current exceeding the  $F 601$ -specified level.

[Parameter setting]

Title	Function	Adjustment range	Default setting
$F 601$	Stall prevention level 1	10-110 (%) / (A).	110
$F 185$	Stall prevention level 2		

[Display during operation of the stall prevention]

During an  $\overline{UL}$  alarm status, (that is, when there is a current flow in excess of the stall prevention level), the output frequency changes. At the same time, to the left of this value, " $\overline{UL}$ " is displayed flashing on and off.

Example of display

$\overline{UL}$  50

- ★ The switching from  $F601$  to  $F185$  can be performed by entering a command through terminals.  
⇒ For more details, see section 6.4.1.

Note: The 100% standard value is the rated output current indicated on the nameplate.

### 6.17.3 Inverter trip retention

**$F602$** : Inverter trip retention selection

- Function  
If the inverter trips, this parameter will retain the corresponding trip information. Trip information that has thus been stored into memory can be displayed, even after power has been reset.

[Parameter setting]

Title	Function	Adjustment range	Default setting
$F602$	Inverter trip retention selection	0: Canceled with the power off 1: Still retained with the power off	0

- ★ The causes of up to four trips that occurred in the past can be displayed in status monitor mode.
- ★ Data displayed in status monitor mode when the inverter is tripped is cleared when power is turned off. Past trip records can be displayed.
- ★ Trip records are retained even if power is turned off and turned back on during retry operation.

■ Flow of operation when  $F602=1$

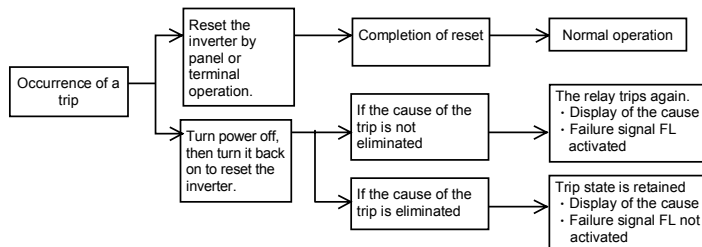

## 6.17.4 Emergency stop

**F503**: Emergency stop

**F504**: Emergency DC braking time

- Function

These parameters allow you to specify how to stop operation using an external control device when an external trip occurs. When operation is stopped, the trip  $\mathcal{E}$  and the FL relay also are activated.

When setting **F503** to 2 (emergency DC braking), set also **F251** (DC braking rate) and **F504** (emergency braking time)

### 1) External trip stop via terminals

The external trip stop function can be executed via the a-contact. Proceed as follows to assign an external stopping terminal and select the stopping method:

[Parameter setting]

Title	Function	Adjustment range	Default setting
<b>F503</b>	Emergency stop selection	0: Coast stop 1: Slowdown stop 2: Emergency DC braking	0
<b>F504</b>	Emergency DC braking time	0.0 ~ 20.0 [sec]	1.0
<b>F251</b>	DC braking current	0-100 (%)	50

(Example of terminal assignment): Assigning the trip stop function to the RES terminal

Title	Function	Adjustment range	Setting value
<b>F113</b>	Input terminal selection 3 (RES)	0-72	11 (External trip stop)

Note 1: Emergency stopping via the specified terminal is possible, even during panel operation.

Note 2: If DC braking is not needed to bring the motor to a stop under normal conditions, although **F503** is set to 2 (emergency DC braking), set the DC braking starting frequency (**F250**) at 0.0 Hz.

### 2) Emergency stopping from the operation panel

Emergency stopping from the operation panel is possible

by pressing the  key on the panel twice while the inverter is not in the panel control mode.

(1) Press the  key ..... "E F F" will blink.

(2) Press the  key once again

Operation will come to a trip stop in accordance with the setting of the **F503** parameter.

After this, "E" will be displayed and a failure detection signal generated (FL relay deactivated).



## 6.17.5 Output phase failure detection

**F605**: Output phase failure detection mode selection

- Function

This parameter detects inverter output Phase failure. If the Phase failure status persists for one second or more, the tripping function and the FL relay will be activated. At the same time, a trip information *EPH0* will also be displayed.

Set *F605* to 5 to open the motor-inverter connection by switching commercial power operation to inverter operation.

Detection errors may occur for special motors such as high-speed motors.

*F605*=0: No tripping (FL relay deactivated).

*F605*=1: With the power on, the phase failure detection is enabled only at the start of the first operation. The inverter will trip if the Phase failure status persists for one second or more.

*F605*=2: The inverter checks for output phase failures each time it starts operation. The inverter will trip if the Phase failure status persists for one second or more.

*F605*=3: The inverter checks for output phase failures during operation. The inverter will trip if the Phase failure status persists for one second or more.

*F605*=4: The inverter checks for output phase failures at the start of and during operation. The inverter will trip if the Phase failure status persists for one second or more.

*F605*=5: If it detects an all-phase failure, it will restart on completion of reconnection.

The inverter does not check for output phase failures when restarting after a momentary power failure.

Note: A check for output phase failures is made during auto-tuning, regardless of the setting of this parameter.

Title	Function	Adjustment range	Default setting
<i>F605</i>	Output phase failure detection mode selection	0: Disabled 1: At start-up (Only one time after power is turned on) 2: At start-up (each time) 3: During operation 4: At start-up + during operation 5: Detection of cutoff on output side	0

## 6.17.6 Input phase failure detection

### **F608**: Input phase failure detection mode selection

- Function  
This parameter detects inverter input Phase failure. If the abnormal voltage status of main circuit capacitor persists for few minutes or more, the tripping function and the FL relay will be activated. Therefore, input phase failures cannot always be detected. A trip information *EPH 1* will be displayed.  
If the power capacity is larger than the inverter capacity (more than 200kVA or more than 10 times), detection errors may occur. If this actually happens, install an input AC reactor.

*F608=0*: No tripping (Failure signal FL not activated)

*F608=1*: Phase failure detection is enabled during operation. The inverter will trip if the abnormal voltage status of main circuit capacitor persists for ten minutes or more. (Failure signal FL activated)

Title	Function	Adjustment range	Default setting
<i>F608</i>	Input phase failure detection mode selection	0: Disabled, 1: Enabled	1

Note: Setting *F608* to 0 (input phase failure detection: disabled) may result in a breakage of the capacitor in the inverter main circuit if operation is continued under a heavy load in spite of the occurrence of an input phase failure.

## 6.17.7 Control mode for small current

### **F609**: Small current detection current hysteresis

### **F610**: Small current trip/alarm selection

### **F611**: Small current detection current

### **F612**: Small current detection time

- Function  
The *F610* parameter allows the inverter to be tripped if a current smaller than the *F611*-specified value flows for more than the *F612*-specified time. When tripping is selected, enter the detection time to tripping. Trip information is displayed as "UL".

*F610=0*: No tripping (Failure signal FL not activated).

A small current alarm can be put out by setting the output terminal function selection parameter.

*F610=1*: The inverter will trip (Failure signal FL activated) if a current below the current set with *F611* flows for the period of time specified with *F612*.

Title	Function	Adjustment range	Default setting
<i>F609</i>	Small current detection current hysteresis	1-20 (%)	10
<i>F610</i>	Small current trip/alarm selection	0: Alarm only 1: Tripping	0
<i>F611</i>	Small current detection current	0-100 (%) / (A)	0
<i>F612</i>	Small current detection time	0-255 [s]	0

<Example of operation>

Output terminal function: 24 (UC) Low current detection

*F610* = 0 (Alarm only)

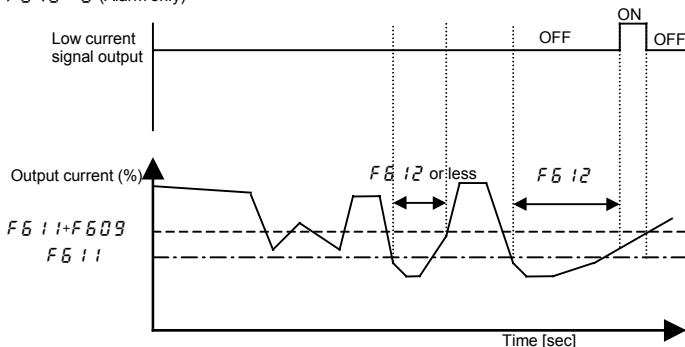

\* When setting *F610* to 1 (Trip), trip after low current detection time setting of *F612*. After tripping, the low current signal remains ON.

## 6.17.8 Detection of output short-circuit

***F613***: Detection of output short-circuit during start-up

- Function

This parameter detects inverter output short-circuit. It can be usually detected in the length of the standard pulse. When operating low-impedance motor such as high-speed motor, however, the short-time pulse should be selected.

*F613*=0: Detection is executed in the length of the standard pulse every time you start up the inverter.

*F613*=1: Detection is executed in the length of standard pulse only during the first start-up after putting on the power or after resetting.

*F613*=2: Detection is executed with the short-time pulse every time you start up the inverter.

*F613*=3: Detection is executed with the short-time pulse only for the first time after putting power on or after resetting.

Title	Function	Adjustment range	Default setting
<i>F6 13</i>	Detection of output short-circuit during start-up	0: Each time (standard pulse) 1: Only one time after power is turned on (standard pulse) 2: Each time (short-time pulse) 3: Only one time after power is turned on (short-time pulse)	0

### 6.17.9 Over-torque trip

***F6 15***: Over-torque trip/alarm selection

***F6 16***: Over-torque detection level

***F6 18***: Over-torque detection time

***F6 19***: Over-torque detection level hysteresis

- Function

Use the *F6 15* parameter to trip the inverter or to output the alarm if a torque current exceeding the *F6 16*-specified level flows for more than the *F6 18*-specified time. Trip information is displayed as "OL".

*F6 15*=0: .....No tripping (FL relay deactivated).

An over-torque alarm can be put out by setting the output terminal function selection parameter.

*F6 15*=1: .....The inverter is tripped (FL relay activated) only after a torque current exceeding the *F6 16*-specified level has been detected for more than the *F6 18*-specified time.

Title	Function	Adjustment range	Default setting
<i>F6 15</i>	Over-torque trip/alarm selection	0: Alarm only 1: Tripping	0
<i>F6 16</i>	Over-torque detection level	0-250 (%)	130
<i>F6 18</i>	Over-torque detection time	0.0-10.0 [s]	0.5
<i>F6 19</i>	Over-torque detection level hysteresis	0-100 (%)	10

<Example of operation>

1) Output terminal function: 12 (OT) Over-torque detection

$F\delta 15 = 0$  (Alarm only)

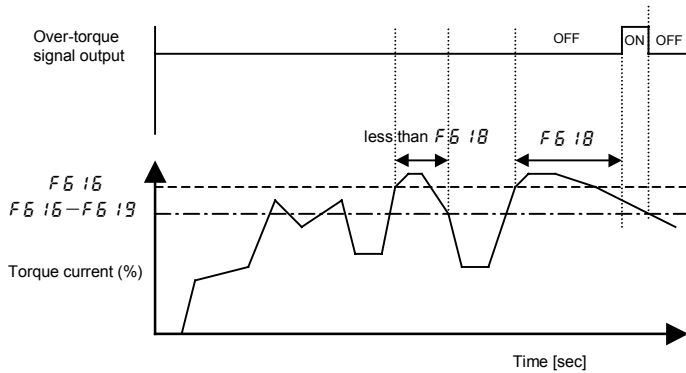

When  $F\delta 15 = 1$  (tripping), the inverter will trip if over-torque lasts for the period of time set with  $F\delta 18$ . In such a case, the over-torque signal remains ON.

2) Output terminal function: 20 (POT) Over-torque detection pre-alarm

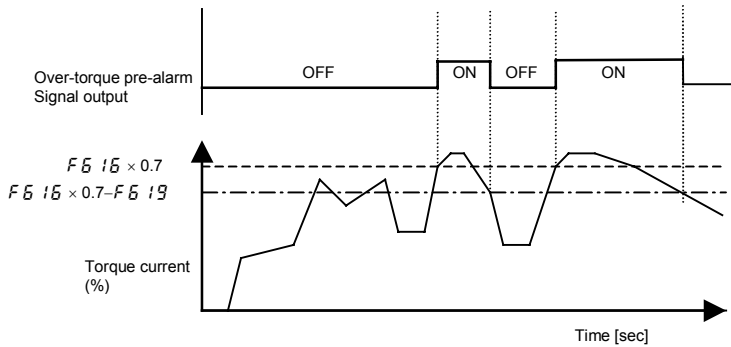

## 6.17.10 Cumulative operation time alarm setting

**F621**: Cumulative operation time alarm setting

- Function  
This parameter allows you to set the inverter so that it will put out an alarm signal after a lapse of the cumulative operation time set with **F621**.

\* "0.1" displayed on the monitor refers to 10 hours, and therefore "1" denotes 100 hours.

Ex.: 38.5 displayed on the monitor = 3850 (hours)

Title	Function	Adjustment range	Default setting
<b>F621</b>	Cumulative operation time alarm setting	0.0-999.9	610.0

■ Setting of output signal I

Ex.: When assigning the cumulative operation alarm signal output function to the RY-RC terminals

Title	Function	Adjustment range	Setting value
<b>F130</b>	Output terminal selection 1A (RY-RC)	0-255	42 (negative logic 43)

## 6.17.11 Over-voltage stall protection level

**F626**: Over-voltage stall protection level

⇒ For more details, see section 6.12.4.

## 6.17.12 Undervoltage trip

**F627**: Undervoltage trip/alarm selection

- Function  
This parameter is used for selecting the control mode when an undervoltage is detected. Trip information is displayed as "UP I".

**F627=0**: The inverter is stopped. However, it is not tripped (Failure signal FL not activated).

The inverter is stopped when the voltage does not exceed 60 % or less of its rating.

**F627=1**: Inverter is stopped. It is also tripped (Failure signal FL activated), only after detection of a voltage not exceeding 60% or less of its rating.

**F627=2**: Inverter is stopped. However, it is not tripped (Failure signal FL not activated). The inverter stop (Failure signal FL not activated.), only after detection of a voltage not exceeding 50% of its rating. Be sure to connect the input reactor.

Title	Function	Adjustment range	Default setting
<b>F627</b>	Undervoltage trip/alarm selection	0: Alarm only (detection level below 60%) 1: Tripping (detection level below 60%) 2: Alarm only (detection level below 50%, input reactor needed)	0

### 6.17.13 Trip at VIA low level input mode

**F633**: Trip at VIA low level input mode

**F644**: Action in the event of VI/II analogue input wire breakage

**F649**: Fallback speed

- Function

The inverter will trip or alarm if the VIA value remains below the specified value for about 0.3 seconds. In such a case, trip: "E - 18", alarm "AL 05" is displayed.

F633=0: Disabled .....The detection function is disabled.

F633=1-100 .....The inverter will trip if the VIA value remains below the specified value for about 0.3 seconds.

Title	Function	Adjustment range	Default setting
F633	Trip at VIA low level input mode	0: Disabled 1-100%	0
F644	Action in the event of VI/II analogue input wire breakage	0: Coast stop (Trip mode E - 18) 1: Coast stop (Alarm mode AL 05) 2: Fallback speed (Alarm mode AL 05) 3: Speed maintain (Alarm mode AL 05) 4: Slowdown stop (Alarm mode AL 05)	0
F649	Fallback speed	0.0-FH	0.0

Note : The VIA input value may be judged earlier to be abnormal, depending on the degree of deviation of the analog data detected.

### 6.17.14 Parts replacement alarms

**F634**: Annual average ambient temperature (For parts replacement alarms)

- Function

You can set the inverter so that it will calculate the remaining useful lives of the cooling fan, main circuit capacitor and on-board capacitor from the ON time of the inverter, the operating time of the motor, the output current (load factor) and the setting of F634, and that it will display and send out an alarm through output terminals when each component is approaching the time of replacement.

Title	Function	Adjustment range	Default setting
F634	Annual average ambient temperature (For parts replacement alarms)	1: -10 to +10°C 2: 11 to 20°C 3: 21 to 30°C 4: 31 to 40°C 5: 41 to 50°C 6: 51 to 60°C	3

- ★ Display of part replacement alarm information  
Part replacement alarm information (⇒ See page H-3) in the Status monitor mode allows you to check on the time of replacement.

An example of display: 



- ★ Output of part replacement alarm signal  
Assign the part replacement alarm function (function No. 44 or 45. ⇒ See page K-18) to an output terminal.  
An example of setting: To assign the function to the RY-RC terminal  
*F 130=44*

Note 1: Using *F 634*, enter the annual average temperature around the inverter. Be careful not to enter the annual highest temperature.

Note 2: Set *F 634* at the time of installation of the inverter, and do not change its setting after the start of use. Changing the setting may cause parts replacement alarm calculation error.

## 6.17.15 Motor PTC thermal protection

**F 645**: PTC thermal selection

**F 646**: Resistor value for PTC detection

- Function  
This function is used to protect motor from overheating using the signal of PTC built-in motor.  
The trip display is "0Hz".

[Parameter setting]

Title	Function	Adjustment range	Default setting
<i>F 645</i>	PTC thermal selection	0: Disabled 1: Enabled (trip mode) 2: Enabled (alarm mode)	0
<i>F 646</i>	PTC detection resistor value	0 - 9999	3000

[Connection]

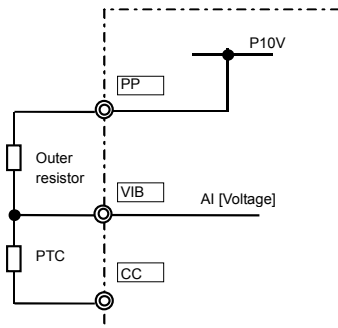

Connect the resistor rated 1/4 watts 3.3k ohm between terminal PP and VIB.

## 6.17.16 Evasion from Overvoltage and Input phase failure

**F481**: Power supply compensation filter

**F482**: Inhibitor filter

**F483**: Inhibitor gain

**F484**: Power supply adjustment gain

- Function

When connecting input reactor or voltage regulator or the impedance of power supply is too big, the following phenomenon are happened.

- Overvoltage trip (*OP1, OP2, OP3*)
- Input phase failure (*EPH1*)
- Unusual noise of inverter

If these phenomena are occurred, the following parameters *F481*~*F483* should be adjusted.

When the using machine has specific resonance, the following phenomena are happened.

- Vibration of machine.
- Unusual noise of machine or Peripheral

If these phenomena are occurred, the following parameters *F481, F484* should be adjusted.

[Parameter setting]

Title	Function	Adjustment range	Default setting
<i>F481</i>	Power supply compensation filter	0-9999 (μs)	0
<i>F482</i>	Inhibitor filter	0-9999 (μs)	442
<i>F483</i>	Inhibitor gain	0.0- 300.0 (%)	100.0
<i>F484</i>	Power supply adjustment gain	0.0~2.0	0.0

At first, please set *F481* as 442 and over. Next, set *F482* and *F483* as bigger value when no effect by setting *F481* as 1000 and over.

At first, please set *F484* as 0.5. Next, *F484* as another value when no effect by setting *F484* as 0.5. Please set *f481* as following value.

Power supply frequency is 50Hz: 531

Power supply frequency is 60Hz: 442

Note

*F481*~*F483* are invalid, when *F484* has a value excluding 0.0.

## 6.18 Forced fire-speed control function

**F550**: Forced fire-speed control function

**F294**: Forced fire-speed setting frequency

- Function

Forced fire-speed control is used when operating the motor at the specified frequency in case of an emergency. Two kind of operation are selectable by assignment of terminal board function.

(1) Input terminal function 52 (FORCE) : Input signal is kept to hold once signal is ON.

Motor runs at the speed set by the parameter "F294".

Motor does not stop as possible as when the trip is occurred.

Note: This case needs to power off in order to stop

(2) Input terminal function 53 (FIRE) : Input signal is kept to hold once signal is ON.

Motor runs at the speed set by the parameter "F294".

Note: This case needs to power off or input terminal function (emergency stop) in order to stop.

[Parameter setting]

Title	Function	Adjustment range	Default setting
F550	Forced fire-speed control selection	0: Disabled 1: Enabled	0
F294	Forced fire-speed setting frequency	LL - UL	50.0

When setting the parameter "F550", "FIRE" is displayed by pressing  $\text{ENT}$  key. It can be set by continuing the  $\text{ENT}$  key for 2 seconds.

[Setting the forced operation input terminal (RES-CC)]

The control terminal "RES" (The default setting is "10: reset function") shall be assigned to "52" (Forced operation function 2) or "53" (Forced operation function 1).

Title	Function	Adjustment range	Setting value
F113	Input terminal selection 3 (RES)	0 - 71	52 ( Forced operation 2 ) or 53 ( Forced operation 1 )

## 6.19 Adjustment parameters

### 6.19.1 Calibration of analog outputs

**F691**: Inclination characteristic of analog output

**F692**: Bias of analog output

- Function  
Output signals from FM terminals are analog voltage signals. Their standard setting range is from 0 to 7.5Vdc.  
Using the FM (SW2) slide switch in the inverter, you can switch to 0-20mA output. Also, using these parameters, you can calibrate the output to 4-20mA or 20-4mA.

Title	Function	Adjustment range	Default setting
<b>F691</b>	Inclination characteristic of analog output	0: Negative inclination (downward slope) 1: Positive inclination (upward slope)	1
<b>F692</b>	Bias of analog output	0-100 (%)	0

Note: To switch to 0-20mA (4-20mA), turn the FM (SW2) slide switch to the 1 position.

#### ■ Example of setting

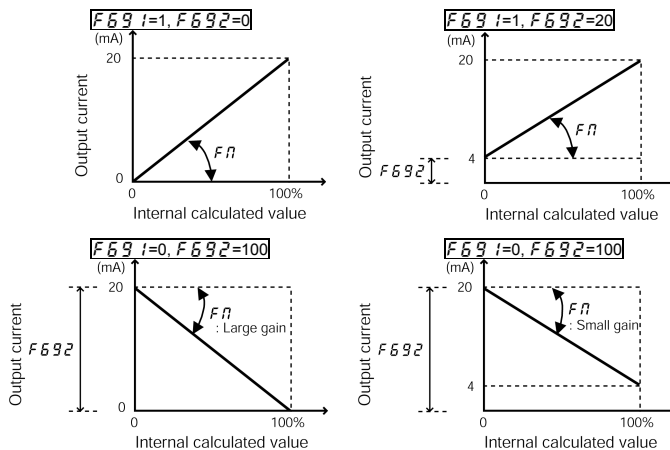

★ The analog output inclination can be adjusted using the parameter  $F69$ .

## 6.20 Operation panel parameter

### 6.20.1 Prohibition of key operations and parameter settings

**F 700**: Prohibition of parameter change

**F 730**: Prohibition of frequency setting on the operation panel (FC)

**F 732**: Prohibition of panel local/remote operation (LOC/REM key)

**F 733**: Prohibition of panel operation (RUN/STOP keys)

**F 734**: Prohibition of panel emergency stop operation

**F 735**: Prohibition of panel reset operation

- Function

These parameters allow you to prohibit the operation of the RUN and STOP keys on the operation panel and the change of parameters. Using these parameters, you can also prohibit various key operations.

[Parameter setting]

Title	Function	Adjustment range	Default setting
<b>F 700</b>	Prohibition of parameter change	0: Permitted, 1: Prohibited	0
<b>F 730</b>	Prohibition of frequency setting on the operation panel (FC)	0: Permitted, 1: Prohibited	0
<b>F 732</b>	Prohibition of panel local/remote operation (LOC/REM key)	0: Permitted 1: Prohibited 2: Permitted (Cancelled with the power off)	0
<b>F 733</b>	Prohibition of panel operation (RUN/STOP keys)	0: Permitted, 1: Prohibited	0
<b>F 734</b>	Prohibition of panel emergency stop operation	0: Permitted, 1: Prohibited	0
<b>F 735</b>	Prohibition of panel reset operation	0: Permitted, 1: Prohibited	0

#### ■ Resetting method

Only the **F 700** parameter is designed so that its setting can be modified even if 1 (prohibited) is selected.

## 6.20.2 Changing the unit to A / V

**F 7 0 1**: Current / voltage unit

- Function  
These parameters are used to change the unit of monitor display.  
%  $\leftrightarrow$  A (ampere) / V (volt)

### ■ Example of setting

During the operation of the VFFS1-2037PM (rated current: 17.5A) at the rated load (100% load), units are displayed as follows:

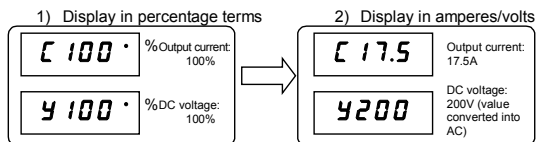

Title	Function	Adjustment range	Default setting
<b>F 7 0 1</b>	Current/voltage display mode	0: % 1: A (ampere)/V (volt)	0

\* The **F 7 0 1** converts the following parameter settings:

- A display Current monitor display
  - Motor electronic-thermal protection level 1 and 2  
*t H r , F 1 7 3*
  - DC braking current  
*F 2 5 1*
  - Stall prevention level 1 and 2  
*F 6 0 1 , F 1 8 5*
  - Small current detection current  
*F 6 1 1*
  - Step-out detection current level  
*F 9 1 0*  
(for PM motors)
- V display Voltage monitor display

Note: Base frequency voltage 1 and 2 (*u L u , F 1 7 1*)s always displayed in the unit of V.

## 6.20.3 Displaying the rotational speed of the motor or the line speed

**F702**: Frequency free unit magnification

**F703**: Frequency free unit conversion selection

**F705**: Inclination characteristic of free unit display

**F706**: Bias of free unit display

- Function

The frequency or any other item displayed on the monitor can be converted freely into the rotational speed of the motor, the operating speed of the load, and so on.

The value obtained by multiplying the displayed frequency by the **F702**-set value will be displayed as follows:

$$\text{Value displayed} = \text{Monitor-displayed or parameter-set frequency} \times \text{F702}$$

1) Displaying the motor speed

To switch the display mode from 60Hz (default setting) to 1800min<sup>-1</sup> (the rotating speed of the 4P motor)

$$\begin{array}{ccc} \boxed{60.0} \text{ Hz} & \longrightarrow & \boxed{1800} \\ \text{F702}=0.00 & & \frac{\text{F702}=30.00}{60 \times 30.00=1800} \end{array}$$

2) Displaying the speed of the loading unit

To switch the display mode from 60Hz (default setting) to 6m/min<sup>-1</sup> (the speed of the conveyer)

$$\begin{array}{ccc} \boxed{60.0} \text{ Hz} & \longrightarrow & \boxed{6.0} \\ \text{F702}=0.00 & & \frac{\text{F702}=0.10}{60 \times 0.10=6.0} \end{array}$$

Note: This parameter displays the inverter output frequency as the value obtained by multiplying it by a positive number. This does not mean that the actual motor speed or line speed are indicated with accuracy.

Title	Function	Adjustment range	Default setting
<i>F 702</i>	Frequency free unit magnification	0.00: Free unit display disabled (display of frequency) 0.01-200.0	0.00
<i>F 703</i>	Frequency free unit conversion selection	0: All frequencies free unit conversion 1: PID frequencies free unit conversion and $F\bar{C}$ range change(0.0~ $FH$ )	0
<i>F 705</i>	Inclination characteristic of free unit display	0: Negative inclination (downward slope) 1: Positive inclination (upward slope)	1
<i>F 706</i>	Bias of free unit display	0.00- $FH$	0.00

\* The  $F 702$  to  $F 706$  converts the following parameter settings:

- $F 703=0$  Frequency monitor display      Operation frequency command, Operation frequency, PID feedback, Frequency command value (PID-computed), Operation frequency command at trip

Frequency-related parameters       $FH, UL, LL, uL, Sr 1-Sr 7, F 100, F 101, F 102, F 167, F 171, F 202, F 204, F 211, F 213, F 240, F 241, F 242, F 250, F 265, F 267, F 268, F 270-F 275, F 294, F 505, F 812, F 814$
- $F 703=1$  Frequency monitor display      PID feedback, Frequency command value (PID-computed)

Frequency-related parameters       $F\bar{C}, FH, F 202, F 204, F 211, F 213, F 392, F 393$

When  $F 703$  was set,  $F 702$  functions only PID control parameters. And the adjustment range  $F\bar{C}$  is changed from 0.0Hz to  $FH$ . Therefore, You must set value of maximum frequency in  $UL$ .



- An example of setting when  $FH$  is 80 and  $F702$  is 10.00

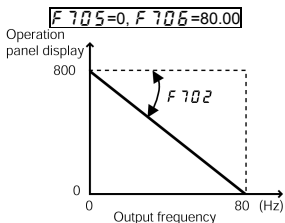
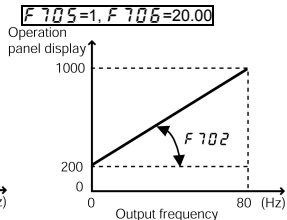
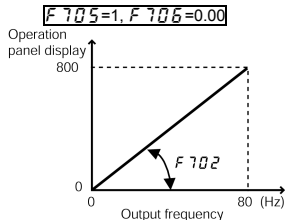

## 6.20.4 Changing the steps in which the value displayed changed

$F707$ : Free step 1 (pressing a panel key once)

$F708$ : Free step 2 (panel display)

- Function

These parameters are used to specify steps in which the command value or standard monitor output frequency displayed on the panel changes each time you press the  $\wedge$   $\vee$  key to set a frequency on the operation panel.

Note 1: The settings of these parameters have no effect when the free unit selection ( $F702$ ) is enabled.

Note 2: If you press the  $\wedge$  key on the panel repeatedly to increase the frequency while  $F707$  is set to any value other than 0, the "HI" alarm will appear immediately before the frequency exceeds the  $FH$  (maximum frequency) and the frequency will stop increasing. Similarly, if you press the  $\vee$  key on the panel repeatedly to decrease the frequency, the "LO" alarm will appear immediately before the frequency decreases below the  $\underline{\underline{L}}$  (lower-limit frequency) and the frequency will stop decreasing.

■ When  $F707$  is not 0.00, and  $F708$  is not 0 (disabled)

Under normal conditions, the frequency command value from the operation panel increases in steps of 0.1 Hz each time you press the  $\triangle$  key. If  $F707$  is not 0.00, the frequency command value will increase by the value with  $F707$  each time you press the  $\triangle$  key. Similarly, it will decrease by the value set with  $F707$  each time you press the  $\nabla$  key.

In this case, the output frequency displayed in standard monitor mode changes in steps of 0.1 Hz, as usual.

■ When  $F707$  is not 0.00, and  $F708$  is not 0 (disabled)

The value displayed on the panel also can also be changed in steps.

$$\boxed{\text{Output frequency displayed in standard monitor mode}} = \boxed{\text{Internal output frequency}} \times \frac{F708}{F707}$$

Title	Function	Adjustment range	Default setting
$F707$	Free step 1 (pressing a panel key once)	0.00: Disabled 0.01- $F H$ (Hz)	0.00
$F708$	Free step 2 (panel display)	0: Disabled 1-255	0

■ Example of setting 1

When  $F707=10.00$  (Hz):

The frequency ( $F\checkmark$ ) set on the operation panel changes in steps of 10.0 Hz: 0.0  $\rightarrow$  10.0  $\rightarrow$  20.0  $\rightarrow$  ... 60.0 (Hz), each time you press the  $\triangle$  key. This function comes in very handy when operating the load at limited frequencies that change in steps of 1Hz, 5Hz, 10Hz, and so on.

### ■ Example of setting 2

When  $F707=1.00$  (Hz), and  $F708=1$ :

Each time you press the  $\Delta$  key, the frequency setting  $F\zeta$  changes in steps of 1Hz:  $0 \rightarrow 1 \rightarrow 2 \rightarrow \dots \rightarrow 60$  (Hz) and also the value displayed on the operation panel changes in steps of 1. Use these settings to hide decimal fractions and also the value displayed on the operation panel changes in steps of 1. Use these settings to hide decimal fractions.

## 6.20.5 Changing the item displayed by default

$F710$ : Standard monitor display selection

- Function  
This parameter specifies display format while power is on.

### ■ Changing the display format while power is on

When the power is on, the standard monitor mode displays the operation frequency (default setting) in the format of " $0.0$ " or " $0FF$ ". This format can be changed to any other monitor display format by setting  $F710$ . This new format, however, will not display an assigned prefix such as  $\zeta$  or  $\zeta$ .



[Parameter setting]

Title	Function	Adjustment range	Default setting
$F710$	Standard monitor display selection	0: Operation frequency (Hz/free unit/step) 1: Frequency command (Hz/free unit/step) 2: Output current (%/A) 3: Inverter rated current (A) 4: Inverter load factor (%) 5: Output power (kW) 6: Frequency command after PID control (Hz/free unit/step) 7: Optional item specified from an external control unit 8: Output speed 9: Communication counter 10: Normal state communication counter	0

- ★ For more information on the  $F710$  option "7," refer to "Communications Function Instruction Manual."

## 6.20.6 Selection of operation panel stop pattern

**F721**: Selection of operation panel stop pattern

- Function  
This parameter are used to select a mode in which the motor started by pressing the  key on the operation panel is stopped when the  key is pressed.

- Slowdown stop  
The motor slows down to a stop in the deceleration time set with *dEC* (or *F501*).
- Coast stop  
The inverter cuts off power supply to the motor. The motor comes to a stop after coasting for a while by inertia. Depending on the load, the motor may keep running for a good long time.

[Parameter setting]

Title	Function	Adjustment range	Default setting
<i>F721</i>	Selection of operation panel stop pattern	0: Slowdown stop 1: Coast stop	0

## 6.20.7 Display of the head of the parameters

**F738**: Head of the parameter display selection

- Function  
The parameter can be set at the front of the setting monitor mode.  
If selecting "1:RUH", the Wizard parameter "RUF" is not displayed.

[Parameter setting]

Title	Function	Adjustment range	Default setting
<i>F738</i>	Head of parameter display selection	0: AUF 1: AUH	0

## 6.20.8 Integral output power

**F748**: Integral output power retention selection

**F749**: Integral output power display unit selection

- Function  
At the main power off ,it is selectable whether retention of integral output power values or not.  
And also, the display unit is selectable.

[Parameter setting]

Title	Function	Adjustment range	Default setting
<i>F 748</i>	Integral output power retention selection	0: Disabled 1: Enabled	1
<i>F 749</i>	Display unit selection for integral output power	0: 1 = 1 kWh 1: 0.1 = 1 kWh 2: 0.01 = 1 kWh 3: 0.001 = 1 kWh	Accoding to model (⇒ See page K-14)

## 6.21 Communication function (RS485)

### 6.21.1 Setting of common function

<b>F800</b> : Communication rate	<b>F851</b> : Operation at communication error by disconnection
<b>F801</b> : Parity	<b>F856</b> : Number of motor poles for communication
<b>F802</b> : Inverter number	<b>F870</b> : Block write data 1
<b>F803</b> : Communication error trip time	<b>F871</b> : Block write data 2
<b>F805</b> : Communication waiting time	<b>F875</b> : Block read data 1
<b>F806</b> : Setting of master and slave for communication between inverters	<b>F876</b> : Block read data 2
<b>F811</b> : Communication command point 1 setting	<b>F877</b> : Block read data 3
<b>F812</b> : Communication command point 1 frequency	<b>F878</b> : Block read data 4
<b>F813</b> : Communication command point 2 setting	<b>F879</b> : Block read data 5
<b>F814</b> : Communication command point 2 frequency	<b>F880</b> : Free notes
<b>F829</b> : Selection of communication protocol	

- Function
  - Function The VF-FS1 Series allows a data communication network to be constructed for exchanging data between a host computer or controller (referred to collectively as the computer) and the inverter by connecting an internal RS485 communication function or optional USB communication conversion unit.
  - <Computer-linking functions>
    - The following functions are enabled by data communication between the computer and inverter
    - (1) Monitoring inverter status (such as the output frequency, current, and voltage)
    - (2) Sending RUN, STOP and other control commands to the inverter
    - (3) Reading, editing and writing inverter parameter settings
  - <USB communication>
    - Data can be exchanged between one computer and one inverter.
  - <RS485 communication>
    - Data can be exchanged between the computer and each of the inverters connected.

- ★ The following are available as communication optional units:
- USB communication conversion unit (Model: USB001Z)  
Communication cable (Model: CAB0011 (1m), CAB0013 (3m), CAB0015 (5m))
  - Internal LonWorks<sup>®</sup> communication circuit board (Model: ILU007Z)
  - Internal BACnet<sup>®</sup> communication circuit board (Model: BCN002Z)
  - Internal Metasys<sup>®</sup> N2 communication circuit board (Model: MTS002Z)
  - Internal Siemens APOGEE<sup>™</sup> FLN communication circuit board (Model: APG002Z)
- These internal products require no interconnect cables, because of built-in type.

## ■ Communication function parameters (Communication options)

The data transfer speed, parity type, inverter number, and communication error trip time can be set/edited by operation panel operation or communication function.

Title	Function	Adjustment range	Default setting
<i>F800</i>	Communication rate	0: 9600bps 1: 19200bps	1
<i>F801</i>	Parity	0: NON (No parity) 1: EVEN (Even parity) 2: ODD (Odd parity)	1
<i>F802</i>	Inverter number	0-247	0
<i>F803</i>	Communication error trip time	0: Disabled (*) 1-100 (s)	0
<i>F805</i>	Communication waiting time	0.00: Regular communication 0.01-2.00 (s)	0.00
<i>F806</i>	Setting of master and slave for communication between inverters	0: Slave (0 Hz command issued in case the master inverter fails) 1: Slave (Operation continued in case the master inverter fails) 2: Slave (Emergency stop tripping in case the master inverter fails) 3: Master (transmission of frequency commands) 4: Master (transmission of output frequency signals)	0
<i>F811</i>	Communication command point 1 setting	0-100 (%)	0
<i>F812</i>	Communication command point 1 frequency	0-200.0 (Hz)	0.0
<i>F813</i>	Communication command point 2 setting	0-100 (%)	100
<i>F814</i>	Communication command point 2 frequency	0.0-200.0 (Hz)	50.0 (WP type) 60.0 (WN type)
<i>F829</i>	Selection of communication protocol	0: Toshiba inverter protocol 1: ModbusRTU protocol 2: Metasys N2 protocol 3: APOGEE FLN protocol 4: BAC-net protocol	0

Title	Function	Adjustment range	Default setting
<i>F851</i>	Operation at communication error by disconnection	0: Inverter stop, communication command, frequency mode open (by <i>CR0d</i> , <i>FR0d</i> ) 1: None (continued operation) 2: Deceleration stop 3: Coast stop 4: Communication error ( <i>Er r 5</i> trip) or Network error ( <i>Er r 8</i> trip)	4
<i>F856</i>	Number of motor poles for communication	1: 2 poles 2: 4 poles 3: 6 poles 4: 8 poles 5: 10 poles 6: 12 poles 7: 14 poles 8: 16 poles	2
<i>F870</i>	Block write data 1	0: No selection 1: Command 1 2: Command 2 3: Frequency command 4: Output data on the terminal board	0
<i>F871</i>	Block write data 2	5: Analog output for communications 6: Motor speed command	0
<i>F875</i>	Block read data 1	0: No selection 1: Status information	0
<i>F876</i>	Block read data 2	2: Output frequency 3: Output current	0
<i>F877</i>	Block read data 3	4: Output voltage 5: Alarm information	0
<i>F878</i>	Block read data 4	6: PID feedback value 7: Input terminal board monitor 8: Output terminal board monitor	0
<i>F879</i>	Block read data 5	9: VIA terminal board monitor 10: VIB terminal board monitor 11: Output motor speed monitor	0
<i>F880</i>	Free notes	0-65535	0

\* Disabled ..... Indicates that the inverter will not be tripped even if a communication error occurs.

Trip ..... The inverter trips when a communication time-over occurs.

In this case a trip information *Er r 5* flashes on and off on the operation panel.



## 6.21.2 Using the RS485

### ■ Setting the communication functions

Setting commands and frequencies by communications has priority over sending commands from the operation panel or the terminal board. Command/frequency setting by communications can therefore be enabled, irrespective of the setting in the command mode ( $\mathcal{C} \mathcal{N} \mathcal{D}$ ) or the frequency setting mode ( $\mathcal{F} \mathcal{N} \mathcal{D}$ ). When inverters are connected to each others, however, in order for slave inverters to recognize frequency signals from the master inverter as frequency commands, the frequency setting mode selection 1 parameter ( $\mathcal{F} \mathcal{N} \mathcal{D}$ ) provided for each slave inverter needs to be set to 4 (serial communications). Refer to the COMMUNICATIONS EQUIPMENT USER'S MANUAL for details.

However, when the input terminal function selection parameter is set to 48: SC/LC (Serial/Local selection), the inverter can be operated with the settings of the command mode ( $\mathcal{C} \mathcal{N} \mathcal{D}$ ) or the frequency setting mode ( $\mathcal{F} \mathcal{N} \mathcal{D}$ ) by external input.

### ■ Transmission specifications

Item	Specifications
Transmission scheme	2-wire, Half-duplex
Connection scheme	Centralized control
Synchronization scheme	Asynchronous
Transmission rate	Default: 19200 baud (parameter setting) Option: Either 9600 or 19200 baud
Character transmission	ASCII code: JIS X 0201 8, 8-bit (fixed) Binary code: Binary, 8-bit (fixed)
Stop bit length	Inverter receiving: 1 bit, Inverter sending: 2 bits
Error detection	Parity: Even, Odd, or None selectable by parameter setting; check sum method
Character transmission format	Receiving: 11-bit, Sending: 12-bit
Order of bit transmission	Least significant bit first
Frame length	Variable to a maximum of 17 bytes

### ■ Example of connection for RS485-communication

<Example of connection>

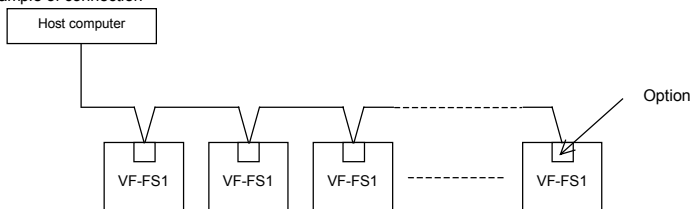

<Independent communication>

Perform computer-inverter connection as follows to send operation frequency commands from the host computer to inverter No. 3:

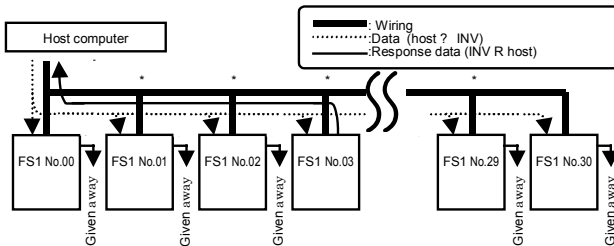

"Given away": Only the inverter with the selected inverter number conducts data processing. All other inverters, even if they have received the data, give it away and stand by to receive the next data.

\* : Use the terminal board to branch the cable.

- (1) Data is sent from the host computer.
- (2) Data from the computer is received at each inverter and the inverter numbers are checked.
- (3) The command is decoded and processed only by the inverter with the selected inverter number.
- (4) The selected inverter responds by sending the processing results, together with its own inverter number, to the host computer.
- (5) As a result, only the selected inverter starts operating in accordance with the operation frequency command by communicating independently.

★ For details of the communication function, refer to the separate instruction manual, "VF-FS1 Communication Function".

Note : Limit the distance between the common serial optional units and the inverter to 5m.

## 6.22 Parameters for options

<b>F890</b>	: Parameter for option 1	<b>F895</b>	: Parameter for option 6
<b>F891</b>	: Parameter for option 2	<b>F896</b>	: Parameter for option 7
<b>F892</b>	: Parameter for option 3	<b>F897</b>	: Parameter for option 8
<b>F893</b>	: Parameter for option 4	<b>F898</b>	: Parameter for option 9
<b>F894</b>	: Parameter for option 5	<b>F899</b>	: Parameter for option 10

These parameters can be used only when specific optional parts are installed. Do not use these parameters unless such parts are installed.

## 6.23 Permanent magnetic motors

<b>F910</b>	: Step-out detection current level
<b>F911</b>	: Step-out detection time
<b>F912</b>	: High-speed torque adjustment coefficient

- Function  
If the permanent magnet motor (PM motor) steps out and if the exciting current increases (it increases in such a case) and remains above the value set with **F910** for the period of time set with **F911**, the inverter will judge the motor to be stepping out and trip it. At that time, the trip message "SOUT" is displayed.

Title	Function	Adjustment range	Default setting
<b>F910</b>	Step-out detection current level	10 ~ 150 (%) / (A)	100
<b>F911</b>	Step-out detection time	0.0: No detection 0.1 ~ 25.0 [s]	0.0
<b>F912</b>	High-speed torque adjustment coefficient	0.00 ~ 650.0	0.00

Note 1: When using an PM motor, consult your Toshiba dealer, since the inverter is not compatible with all types of PM motors.

Note 2: The inverter may fail to detect step-out in some cases, because it uses an electrical method to detect step-out. To avoid detection failures, you are recommended to install a mechanical step-out detector.

Note 3: There is no need adjust **F912** under normal conditions. (Do not change the setting, unless otherwise instructed by Toshiba technical staff.)

## 7. Applied operation

Applied operation can be performed by selecting the frequency mode and command mode setting. However in case the LOCAL mode is selected by  key (lighting a LOC/REM lamp), frequency setting mode and command mode are fixed operation panel key setting mode. The following explanations are applied REMOTE mode only.

### 7.1 Setting the operation frequency

Applied operation can be performed by selecting the inverter frequency setting. To make settings for applied operation, use the basic parameter  $F\dot{N}\dot{Q}d$  (selection of frequency setting mode 1), and the extended parameters  $F\dot{Z}\dot{Q}Q$  (frequency priority selection) and  $F\dot{Z}\dot{Q}7$  (selection of frequency setting mode 2).

(1) Operation panel key setting

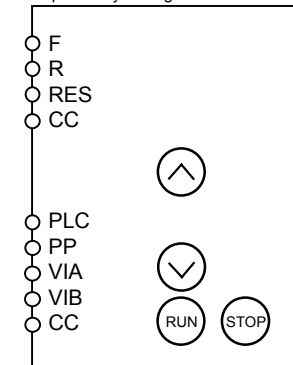

$F\dot{N}\dot{Q}d:3$   
 $F\dot{Z}\dot{Q}Q:0$

Enter the number with the operation panel keys, then press the  key to conform. (Save the setting)

(2) External potentiometer setting

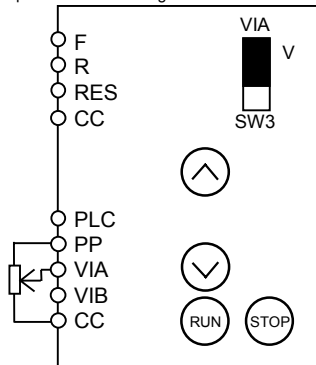

$F\dot{N}\dot{Q}d:1$   
 $F\dot{Z}\dot{Q}Q:0$

Use the parameters  $F\dot{Z}\dot{Q}1$  to  $F\dot{Z}\dot{Q}4$  for this setting.

(3) Input voltage setting 1 (0 to 10 Vdc)

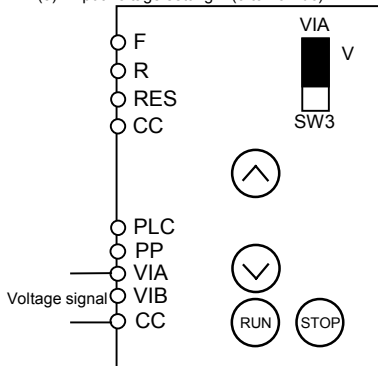

*F 2 0 d: 1*  
*F 2 0 0: 0*

Use the parameters *F 2 0 1* to *F 2 0 4* for this setting.

(4) Input voltage setting 2 (0 to 10 Vdc)

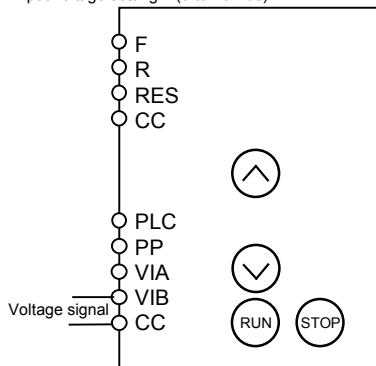

*F 2 0 d: 2*  
*F 2 0 0: 0*

Use the parameters *F 2 1 0* to *F 2 1 3* for this setting.

(5) Input current setting (4 to 20 mAcd)

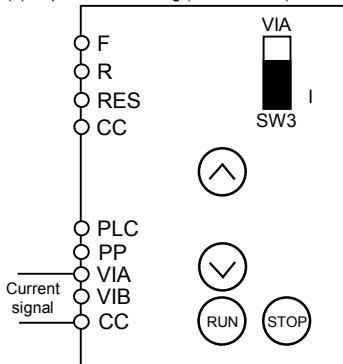

*F 2 0 d: 1*  
*F 2 0 0: 0*

Use parameters *F 2 0 1* to *F 2 0 4* for this setting.  
(*F 2 0 1: 20%*)

(6) External contact UP/DOWN

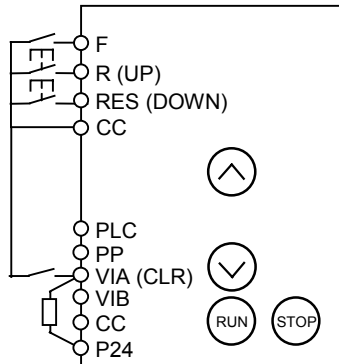

*F 2 0 d: 5, F 2 0 0: 0*

Use the parameters *F 2 5 4* to *F 2 5 8* for this setting.

To change the frequency when power is off, set *F 2 5 9: 1*  
(Rewriting of *F 2 5 8* when power is turned off.)

*F 1 1 2: 4 1* (Allocation of UP)

*F 1 1 3: 4 2* (Allocation of DOWN)

*F 1 1 8: 4 3* (Allocation of CLR)

*F 1 0 9: 1* (VIA-contact input (Sink))

\* Insert a resistor between P24 and VIA terminal.

(Recommended value: 4.7kΩ-1/2W)

(7) Preset-speed

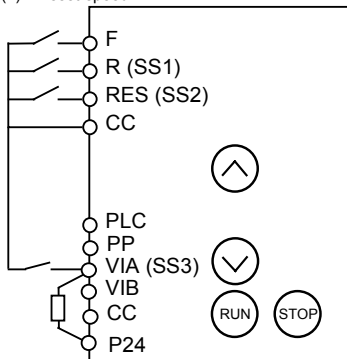

*F 1 0 d: 0* (Terminal board)  
*S r 1 to S r 7: 1-7-speed run*  
 To select 7-speed run, use the terminals R, RES and VIA.  
*F 1 1 2: 5* (Allocation of SS1)  
*F 1 1 3: 7* (Allocation of SS2)  
*F 1 1 8: 8* (Allocation of SS3)  
*F 1 0 9: 1* (VIA-contact input (Sink))  
 \* Insert a resistor between P24 and VIA terminal.  
 (Recommended value: 4.7kΩ-1/2W)

(8) Voltage/current switching 1

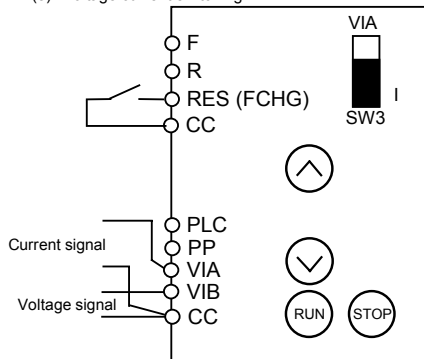

*F 2 0 0: 0* (Forced switching of FCHG)  
*F 1 1 3: 3 8* (Allocation of FCHG)  
*F 1 0 d: 1*  
*F 2 0 7: 2*  
*F 2 0 1 ~ F 2 0 4: need adjustment*  
*F 2 1 0 ~ F 2 1 3: need adjustment*

(9) Voltage/current switching 2

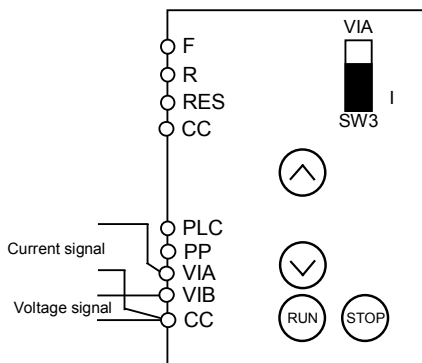

*F 2 0 0*: 1 (Automatic switching)  
*F 1 0 d*: 1  
*F 2 0 7*: 2  
*F 2 0 1*~*F 2 0 4*: need adjustment  
*F 2 1 0*~*F 2 1 3*: need adjustment

(10) Switching between analog setting and preset speed setting

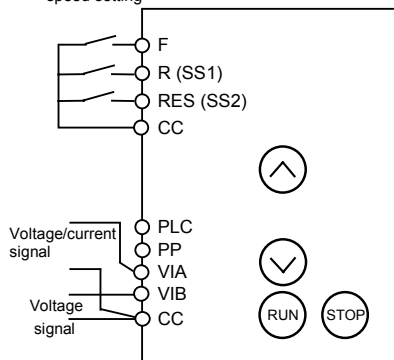

*F 1 0 d*: 1 (VIA) or 2 (VIB)  
*C 1 0 d*: 0 (Terminal board)  
*F 2 0 0*: 0  
 To switch to preset-speed setting, use the external terminals R and RES  
*F 1 1 2*: 6 (Allocation of SS1)  
*F 1 1 3*: 7 (Allocation of SS2)

(11) Switching between analog setting and terminal setting from the operation panel

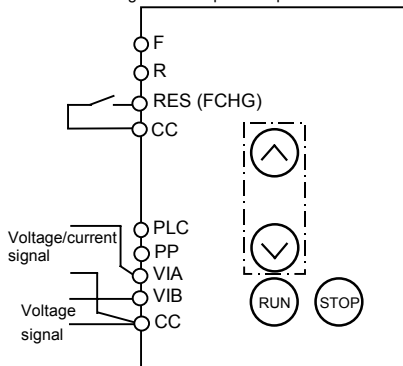

*F 1 0 d*: 3 (Operation panel)  
*F 1 1 3*: 3B (Allocation of FCHG)  
 To switch to *F 2 0 7* setting, enter the command through FCHG.  
*F 2 0 0*: 0 *F 2 0 7*: 1(VIA) or 2 (VIB).

(12) Setting by means of a remote input device

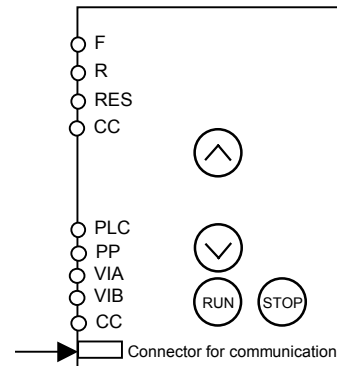

*F 1 0 d*: 4 (communication)

(13) Switching between communication and terminal control

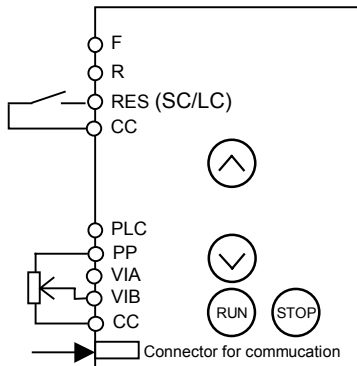

Communication command FA00h 14bit: 1  
*F* *0* *0* *0*: for 2  
*F* *1* *1* *3*: 4B (Allocation of SL/LC)  
 Switched to terminal when a command is entered through SC and LC during operation by means of communication

## 7.2 Setting the operation mode

Applied operation can be performed by selecting the operation mode. To set the operation mode, use the basic parameter *LR0d* (command mode selection) and the input terminal selection parameter.

(1) Operation panel operation

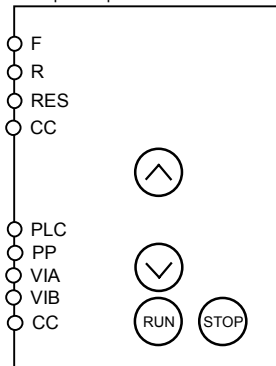

*LR0d*: 1 (Operation panel)

(2) Terminal board operation

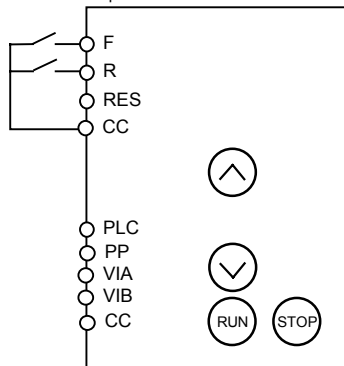

*LR0d*: 0 (Terminal board)



(3) Operation from an external input device

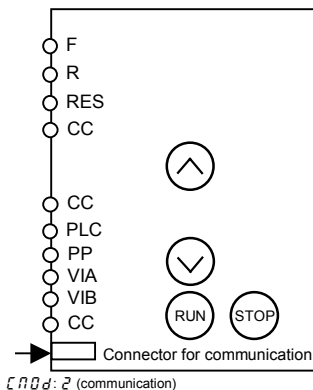

(4) Switching from communication to the terminal board

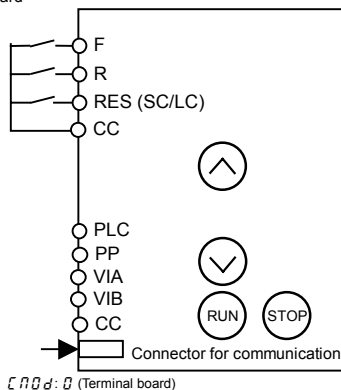

F 1 1 3: 4 B (Allocation of SC/LC)

Remote control can be switched forcefully to terminal control from the external SC/LC by setting the remote command FA00h 15-bit at 1.

Operation is controlled from the terminal board.

## 8. Monitoring the operation status

Refer to section 4.1 about flow of monitor.

### 8.1 Status monitor mode













#### 8.1.1 Status monitor under normal conditions

In this mode, you can monitor the operation status of the inverter.

To display the operation status during normal operation:











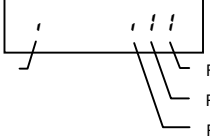



Press the  key twice.

Setting procedure (eg. operation at 60Hz)

Item displayed	Key operated	LED display	Communication No.	Description
		60.0		The operation frequency is displayed (Operation at 60Hz). (When standard monitor display selection <i>F 7 i 0</i> is set at 0 (operation frequency))
Parameter setting mode		RUF		The first basic parameter "RUF" (Wizard function) is displayed.
Direction of rotation		F r - F	FE01	The direction of rotation is displayed. (F r - F: forward run, F r - r: reverse run)
Note 1 Operation frequency command		F 60.0	FE02	The operation frequency command value (Hz/free unit) is displayed.
Note 2 Load current		ℓ 80	FE03	The inverter output current (load current) (%A) is displayed.
Note 3 Input voltage		4 100	FE04	The inverter input voltage (DC detection) (%V) is displayed.
Output voltage		P 100	FE05	The inverter output voltage (%V) is displayed.
Torque		9 60	FE18	The torque (%) is displayed.
Torque current		c 90	FE20	The torque current (%A) is displayed.
Inverter load factor		ℓ 70	FE27	The inverter load factor (%) is displayed.
Input power		h 80	FE29	The inverter input power (kW) is displayed.
Output power		H 75	FE30	The inverter output power (kW) is displayed.
Operation frequency		σ 60.0	FD00	The operation frequency (Hz/free unit) is displayed.

(Continued overleaf)

(Continued)

Item displayed	Key operated	LED display	Communication No.	Description
Note 4 Input terminal		, . . . ! !	FE06	The ON/OFF status of each of the control signal input terminals (F, R, RES and VIA) is displayed in bits. ON: ! OFF: , 
Output terminal		0 . . !	FE07	The ON/OFF status of each of the control signal output terminals (RY and FL) is displayed in bits. ON: ! OFF: , 
CPU1 version		u 10 !	FE08	The version of the CPU1 is displayed.
CPU2 version		u c 0 !	FE73	The version of the CPU2 is displayed.
Memory version		u E 0 0	FE09	The version of the memory mounted is displayed.
PID feedback		d 5 0	FE22	The PID feedback value is displayed. (Hz/free unit)
Frequency command value (PID-computed)		b 7 0	FE15	The PID-computed frequency command value is displayed. (Hz/free unit)
Note 5 Integral input power		h 8 5	FE76	The integrated amount of power (kWh) supplied to the inverter is displayed.
Note 5 Integral output power		H 7 5	FE77	The integrated amount of power (kWh) supplied from the inverter is displayed.
Rated current		R 1 6 . 5	FE70	The rated current of the inverter (A) is displayed.
Output speed		1 5 0 0	FE90	Displays the motor speed (min-1) by calculating with output frequency and pole numbers.
Communication counter		n 5 0	FA15	Displays the counter numbers of communication through the network.
Normal state communication counter		n 5 0	FA16	Displays the counter numbers of communication only at normal state in the all communication through network.

(Continued overleaf)













(Continued)

	Item displayed	Key operated	LED display	Communication No.	Description
Note 6	Past trip 1		0C3 ⇔ 1	FE10	Past trip 1 (displayed alternately)
Note 6	Past trip 2		0H ⇔ 2	FE11	Past trip 2 (displayed alternately)
Note 6	Past trip 3		0P3 ⇔ 3	FE12	Past trip 3 (displayed alternately)
Note 6	Past trip 4		nErr ⇔ 4	FE13	Past trip 4 (displayed alternately)
Note 7	Parts replacement alarm information		n . . . .	FE79	<p>The ON/OFF status of each of the cooling fan, circuit board capacitor, main circuit capacitor of parts replacement alarm or cumulative operation time are displayed in bits.</p> <p>ON: ! OFF: .</p>
Note 8	Cumulative operation time		t0.10	FE14	The cumulative operation time is displayed. (0.01=1 hour, 1.00=100 hours)
	Default display mode		60.0		The operation frequency is displayed (Operation at 60Hz).

## 8.1.2 Display of detailed information on a past trip

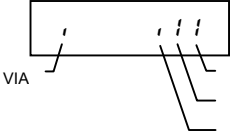
Details on a past trip (of trips 1 to 4) can be displayed, as shown in the table below, by pressing the  key when the trip record is selected in the status monitor mode.

Unlike the "Display of detailed trip information at the occurrence of a trip" in 8.2.2, details on a past trip can be displayed, even after the inverter is turned off or reset.

	Item displayed	Key operated	LED display	Description
Note 10	Past trip 1		$\square \square \square \square \square \square$	Past trip 1 (displayed alternately)
	Continuous trips		$n \square$	The number of time the same trip occurred in succession is displayed. (Unit: times)
Note 1	Operation frequency		$\square \square \square \square$	The operation frequency when the trip occurred is displayed.
	Direction of rotation		$F r - F$	The direction of rotation when the trip occurred is displayed. ( $F r - F$ : Forward run, $F r - r$ : Reverse run)
	Operation frequency command		$F \square \square \square$	The operation command value when the trip occurred is displayed.
Note 2	Load current		$\square \square \square$	The inverter output current when the trip occurred is displayed. (%/A)
Note 3	Input voltage		$\square \square \square$	The inverter input voltage (DC detection) when the trip occurred is displayed. (%/V).
	Output voltage		$\square \square \square$	The inverter output voltage when the trip occurred is displayed. (%/V)
Note 4	Input terminal		$\square \square \square \square$	The ON/OFF statuses of the control input terminals (F, R, RES and VIA) are displayed in bits. 
Note 5	Output terminal		$\square \square \square \square$	The ON/OFF statuses of the control output terminals (RY and FL) are displayed in bits. 
Note 8	Cumulative operation time		$\square \square \square \square$	The cumulative operation time when the trip occurred is displayed. (0.01=1 hour, 1.00=100 hours)
	Past trip 1		$\square \square \square \square \square \square$	Press this key to return to past trip 1.

## 8.2 Display of trip information

### 8.2.1 Trip code display

If the inverter trips, an error code is displayed to suggest the cause. Since trip records are retained, information on each trip can be displayed anytime in the status monitor mode.

#### ■ Display of trip information

Error code	Failure code	Description
<i>nErr</i> (*)	0000	No error
<i>OC1</i>	0001	Overcurrent during acceleration
<i>OC2</i>	0002	Overcurrent during deceleration
<i>OC3</i>	0003	Overcurrent during constant speed operation
<i>OC4</i>	0004	Load-side overcurrent during start-up
<i>OC5</i>	0005	Armature-side overcurrent during start-up
<i>EPH1</i>	0008	Input phase failure or exhaustion of main circuit capacitor
<i>EPH0</i>	0009	Output phase failure
<i>OP1</i>	000A	Overvoltage during acceleration
<i>OP2</i>	000B	Overvoltage during deceleration
<i>OP3</i>	000C	Overvoltage during constant-speed operation
<i>OL1</i>	000D	Inverter overload trip
<i>OL2</i>	000E	Motor overload trip
<i>OH</i>	0010	Overheating trip or thermal detector failure
<i>E</i>	0011	Emergency stop
<i>EEP1</i>	0012	E <sup>2</sup> PROM fault 1 (writing error)
<i>EEP2</i>	0013	E <sup>2</sup> PROM fault 2 (initialization error) or power-off during the setting of <i>t<sub>CP</sub></i>
<i>EEP3</i>	0014	E <sup>2</sup> PROM fault 3 (reading error)
<i>Err2</i>	0015	Inverter RAM fault
<i>Err3</i>	0016	Inverter ROM fault
<i>Err4</i>	0017	CPU fault trip 1
<i>Err5</i>	0018	Communication error
<i>Err7</i>	001A	Current defector fault
<i>Err8</i>	001B	Network error
<i>UC</i>	001D	Small-current trip
<i>UP1</i>	001E	Undervoltage trip
<i>Ot</i>	0020	Over-torque trip
<i>EF2</i>	0022	Ground fault
<i>OC1P</i>	0025	Overcurrent flowing in element during acceleration

(Continued overleaf)

(Continued)

Error code	Failure code	Description
$0C2P$	0026	Overcurrent flowing in element during deceleration
$0C3P$	0027	Overcurrent flowing in element during constant-speed operation
$Etn1$	0054	Auto-tuning error
$EtyP$	0029	Inverter type error
$0H2$	002E	External thermal input
$E-18$	0032	VIA cable break
$E-19$	0033	Communication error between CPUs
$E-20$	0034	V/F control error
$E-21$	0035	CPU fault 2
$50Ut$	002F	Step-out (for PM motors only)

Note: Past trip records (trip records retained or trips that occurred in the past) can be called up.

⇒ See section 8.1 "Status monitor mode" for the call-up procedure.







(\*) Strictly speaking, this code is not an error code; this code is displayed to show the absence of error when the past trip monitor mode is selected.

## 8.2.2 Display of trip information at the occurrence of a trip

At the occurrence of a trip, the same information as that displayed in the mode described in 8.1.1, "Status monitor under normal conditions," can be displayed, as shown in the table below, if the inverter is not turned off or reset.

To display trip information after turning off or resetting the inverter, follow the steps described in 8.1.2, "Display of detailed information on a past trip."

### ■ Example of call-up of trip information

	Item displayed	Key operated	LED display	Communication No.	Description
	Cause of trip		$0P2$	/	Status monitor mode (The code blinks if a trip occurs.) The motor coasts and comes to a stop (coast stop).
	Parameter setting mode		$RUF$		The first basic parameter " $RUF$ " (Wizard function) is displayed.
	Direction of rotation		$Fr - F$	FE01	The direction of rotation at the occurrence of a trip is displayed. ( $F_r - F$ : forward run, $F_r - r$ : reverser run).
Note 1	Operation frequency command		$F60.0$	FE02	The operation frequency command value (Hz/free unit) at the occurrence of a trip is displayed.
Note 2	Load current		$L130$	FE03	The output power of the inverter at the occurrence of a trip (%A) is displayed.
Note 3	Input voltage		$Y141$	FE04	The inverter input voltage (DC detection) (%V) at the occurrence of a trip is displayed.
	Output voltage		$P100$	FE05	The output voltage of the inverter at the occurrence of a trip (%V) is displayed.

(Continued overleaf)

(Continued)

Item displayed	Key operated	LED display	Communication No.	Description
Torque		q 50	FE18	The torque at the occurrence of a trip (%) is displayed.
Torque current		c 90	FE20	The torque current (%/A) at the occurrence of a trip is displayed.
Inverter load factor		L 70	FE27	The inverter load factor (%) at the occurrence of a trip is displayed.
Input power		h 80	FE29	The inverter input power (kW) at the occurrence of a trip is displayed.
Output power		H 75	FE30	The inverter output power (kW) at the occurrence of a trip is displayed.
Operation frequency		a 50.0	FE00	The inverter output frequency (Hz/free unit) at the occurrence of a trip is displayed.
Note 4 Input terminal		, . . .	FE06	The ON/OFF statuses of the control input terminals (F, R, RES and VIA) are displayed in bits. 
Output terminal		0 . . .	FE07	The ON/OFF status of each of the control signal output terminals (RY and FL) at the occurrence of a trip is displayed in bits. 
CPU1 version		u 101	FE08	The version of the CPU1 is displayed.
CPU2 version		uc 01	FE73	The version of the CPU2 is displayed.
Memory version		uE 01	FE09	The version of the memory mounted is displayed.
PID feedback		d 50	FE22	The PID feedback value at the occurrence of a trip is displayed. (Hz/free unit)
Frequency command value (PID-computed)		b 70	FE15	The PID-computed frequency command value at the occurrence of a trip is displayed. (Hz/free unit)
Integral input power		h 85	FE76	The integrated amount of power (kWh) supplied to the inverter is displayed. (0.01=1kWh, 1.00=100kWh)

(Continued overleaf)





(Continued)

Item displayed	Key operated	LED display	Communication No.	Description
Integral output power		H 75	FE77	The integrated amount of power (kWh) supplied from the inverter is displayed. (0.01=1kWh, 1.00=100kWh)
Rated current		R 16.5	FE70	The inverter rated current (A) at the occurrence of a trip is displayed.
Output speed		1500	FE90	Displays the motor speed (min <sup>-1</sup> ) by calculating with output frequency and pole numbers.
Communication counter		n 50	FA15	Displays the counter numbers of communication through the network. Note that they are current values, not at tripping.
Normal state communication counter		n 50	FA16	Displays the counter numbers of communication only at normal state in the all communication through network. Note that they are current values, not at tripping.
Note 6 Past trip 1		OP2 ⇔ 1	FE10	Past trip 1 (displayed alternately)
Note 6 Past trip 2		OH ⇔ 2	FE11	Past trip 2 (displayed alternately)
Note 6 Past trip 3		OP3 ⇔ 3	FE12	Past trip 3 (displayed alternately)
Note 6 Past trip 4		n Err ⇔ 4	FE13	Past trip 4 (displayed alternately)
Note 7 Parts replacement alarm information		n . . . .	FE79	The ON/OFF status of each of the cooling fan, circuit board capacitor, main circuit capacitor of parts replacement alarm or cumulative operation time are displayed in bits.  ON: ! OFF: .   Cumulative operation time      Cooling fan Control circuit board capacitor Main circuit capacitor
Note 8 Cumulative operation time		t 0. 10	FE14	The cumulative operation time is displayed. (0.01=1 hour, 1.00=100 hours)
Default display mode	MODE	OP2		The cause of the trip is displayed.

Note 1: Items displayed can be changed by pressing or key in the each monitor mode.

Note 2: You can switch between % and A (ampere)/V (volt), using the parameter  $F 7 \bar{0} \bar{1}$  (current/voltage unit selection).

Note 3: The input (DC) voltage displayed is  $1\sqrt{2}$  times as large as the rectified d.c. input voltage.

- Note 4: The number of bars displayed varies depending on the setting of  $F109$  (analog input/logic input function selection). The bar representing VIA is displayed only when the logic input function is assigned to the VIA terminal, respectively.  
 If  $F109 = 0$ : The bar representing VIA is not displayed.  
 If  $F109 = 1$  or  $2$ : The bar representing VIA is displayed.
- Note 5: The integrated amounts of input and output power will be reset to zero, if you press and hold down the  key for 3 seconds or more when power is off or when the input terminal function CKWH (input terminal function: 51) is turned on or displayed.
- Note 6: Past trip records are displayed in the following sequence: 1 (latest trip record)  $\leftrightarrow 2 \leftrightarrow 3 \leftrightarrow 4$  (oldest trip record). If no trip occurred in the past, the message "n E r r" will be displayed. Details on past trip record 1, 2, 3 or 4 can be displayed by pressing the  key when past trip 1, 2, 3 or 4 is displayed.  
 $\Rightarrow$  For more information, see section 8.1.2.
- Note 7: Parts replacement alarm is displayed based on the value calculated from the annual average ambient temperature, the ON time of the inverter, the operating time of the motor and the output current (load factor) specified using  $F534$ . Use this alarm as a guide only, since it is based on a rough estimation.
- Note 8: The cumulative operation time increments only when the machine is in operation.
- Note 9: At the occurrence of a trip, maximum values are not always recorded and displayed for reasons of detecting time.
- Note 10: If there is no trip record, n E r r is displayed.
- ★ Of the items displayed on the monitor, the reference values of items expressed in percent are listed below.
- Load current: The current monitored is displayed. The reference value (100% value) is the rated output current indicated on the nameplate. The unit can be switched to A (amperes).
  - Input voltage: The voltage displayed is the voltage determined by converting the voltage measured in the DC section into an AC voltage. The reference value (100% value) is 200 volts for 200V models, 400 volts for 400V models. The unit can be switched to V (volts).
  - Torque: The torque generated by the drive motor is displayed. The reference value (100% value) is the rated torque of the motor (same as inverter rating).
  - Torque current: The current required to generate torque is calculated from the load current by vector operations. The value thus calculated is displayed. The reference value (100% value) is the value at the time when the load current is 100%.
  - Load factor of inverter: Depending on the PWM carrier frequency ( $F300$ ) setting and so on, the actual rated current may become smaller than the rated output current indicated on the nameplate. With the actual rated current at that time (after a reduction) as 100%, the proportion of the load current to the rated current is indicated in percent. The load factor is also used to calculate the conditions for overload trip ( $0L1$ ).

## 9. Measures to satisfy the standards

### 9.1 How to cope with the CE directive

In Europe, the EMC directive and the low-voltage directive, which took effect in 1996 and 1997, respectively, make it obligatory to put the CE mark on every applicable product to prove that it complies with the directives. Inverters do not work alone but are designed to be installed in a control panel and always used in combination with other machines or systems which control them, so they themselves are not considered to be subject to the EMC directive. However, the CE mark must be put on all inverters because they are subject to the low-voltage directive.

The CE mark must be put on all machines and systems with built-in inverters because such machines and systems are subject to the above directives. It is the responsibility of the manufacturers of such final products to put the CE mark on each one. If they are "final" products, they might also be subject to machine-related directives. It is the responsibility of the manufacturers of such final products to put the CE mark on each one. In order to make machines and systems with built-in inverters compliant with the EMC directive and the low-voltage directive, this section explains how to install inverters and what measures should be taken to satisfy the EMC directive.

We have tested representative models with them installed as described later in this manual to check for conformity with the EMC directive. However, we cannot check all inverters for conformity because whether or not they conform to the EMC directive depends on how they are installed and connected. In other words, the application of the EMC directive varies depending on the composition of the control panel with a built-in inverter(s), the relationship with other built-in electrical components, the wiring condition, the layout condition, and so on. Therefore, please verify yourself whether your machine or system conforms to the EMC directive.

#### 9.1.1 About the EMC directive

Inverters themselves are not subject to approval for CE marking.

The CE mark must be put on every final product that includes an inverter(s) and a motor(s). The VF-FS1 series of inverters complies with the EMC directive if an EMI filter recommended by Toshiba is connected to it and wiring is carried out correctly.

The EMC standards are broadly divided into two categories; immunity- and emission-related standards, each of which is further categorized according to the operating environment of each individual machine. Since inverters are intended for use with industrial systems under industrial environments, they fall within the EMC categories listed in Table 1 below. The tests required for machines and systems as final products are almost the same as those required for inverters.

Table 1 EMC standards

Category	Subcategory	Product standards	Test standard and level	
Emission	Radiation noise	IEC 61800-3	CISPR11(EN55011)	
	Transmission noise		CISPR11(EN55011)	
Immunity	Static discharge		IEC61000-4-2	
	Radioactive radio-frequency magnetic contactor field		IEC61000-4-3	
	First transient burst		IEC61000-4-4	
	Lightning surge		IEC61000-4-5	
	Radio-frequency induction/transmission interference		IEC61000-4-6	
	Voltage dip/Interruption of power			IEC61000-4-11

## 9.1.2 Measures to satisfy the EMC directive

This subsection explains what measures must be taken to satisfy the EMC directive.

- (1) Insert a recommended EMI filter (Table 2) on the input side of the inverter to reduce and transmission noise and radiation noise from input cables.

In the combinations listed in Table 2, Inverters are tested in these combination to see if they comply with transmission noise standards. For inverters used in Japan, it is recommended to use the NF series of noise filters.

Table 2 lists noise filters recommended for the inverters.

Table 2 Combinations of inverter and EMI filter

Three-phase 200V class

Inverter	Combination of inverter and filter	
	Transmission noise EN61800-3, 1st Environment, C2	
	Applicable filters	Length of motor connecting cable (m)
VFFS1-2004PM	EMFS11-4015BZ	20
VFFS1-2007PM	EMFS11-4015BZ	20
VFFS1-2015PM	EMFS11-4015BZ	20
VFFS1-2022PM	EMFS11-4015BZ	20
VFFS1-2037PM	EMFS11-4025CZ	20
VFFS1-2055PM	EMFS11-4047DZ	20
VFFS1-2075PM	EMFS11-4047DZ	20
VFFS1-2110PM	EMFS11-2083EZ	20
VFFS1-2150PM	EMFS11-2083EZ	20
VFFS1-2185PM	EMFS11-2083EZ	20
VFFS1-2220PM	EMF3-4090F	20
VFFS1-2300PM	EMF3-4180H	20

## Three-phase 400V class

Inverter	Combination of inverter and filter					
	Transmission noise EN61800-3, 1st Environment, C2		Transmission noise EN61800-3, 1st Environment, C3		Transmission noise EN61800-3, 2nd Environment, C1	
	Applicable filters	Length of motor connecting cable (m)	Applicable filters	Length of motor connecting cable (m)	Applicable filters	Length of motor connecting cable (m)
VFFS1-4004PL	With a built-in filter	5	-	-	EMFS11-4015BZ	20
VFFS1-4007PL	With a built-in filter	5	-	-	EMFS11-4015BZ	20
VFFS1-4015PL	With a built-in filter	5	-	-	EMFS11-4015BZ	20
VFFS1-4022PL	With a built-in filter	5	-	-	EMFS11-4015BZ	20
VFFS1-4037PL	With a built-in filter	5	-	-	EMFS11-4025CZ	20
VFFS1-4055PL	With a built-in filter	5	-	-	EMFS11-4025CZ	20
VFFS1-4075PL	With a built-in filter	5	-	-	EMFS11-4047DZ	20
VFFS1-4110PL	With a built-in filter	5	-	-	EMFS11-4047DZ	20
VFFS1-4150PL	With a built-in filter	5	-	-	EMFS11-4049EZ	20
VFFS1-4185PL	With a built-in filter	5	-	-	EMFS11-4049EZ	20
VFFS1-4220PL	-	-	With a built-in filter	5	EMF3-4090F	100
VFFS1-4300PL	-	-	With a built-in filter	5	EMF3-4090F	100
VFFS1-4370PL	-	-	With a built-in filter	20	EMF3-4092G	100
VFFS1-4450PL	-	-	With a built-in filter	20	EMF3-4092G	100
VFFS1-4450PL	-	-	With a built-in filter	100	EMF3-4180H	100
VFFS1-4750PL	-	-	With a built-in filter	100	EMF3-4180H	100

- (2) Use shielded power cables, such as inverter output cables, and shielded control cables. Route the cables and wires so as to minimize their lengths. Keep a distance between the power cable and the control cable and between the input and output wires of the power cable. Do not route them in parallel or bind them together, instead cross at right angle.
- (3) Install the inverter and the filter on the same metal plate. It is more effective in limiting the radiation noise to install the inverter in a sealed steel cabinet. Using wires as thick and short as possible, earth the metal plate and the control panel securely with a distance kept between the earth cable and the power cable.
- (4) Route the EMI filter input and output wires apart from each other.
- (5) To suppress radiation noise from cables, ground all shielded cables through a noise cut plate. It is effective to earth shielded cables in the vicinity of the inverter, cabinet and filter (within a radius of 10cm from each of them). Inserting a ferrite core in a shielded cable is even more effective in limiting the radiation noise.
- (6) To further limit the radiation noise, insert a zero-phase reactor in the inverter output line and insert ferrite cores in the earth cables of the metal plate and cabinet.

[Example of wiring]

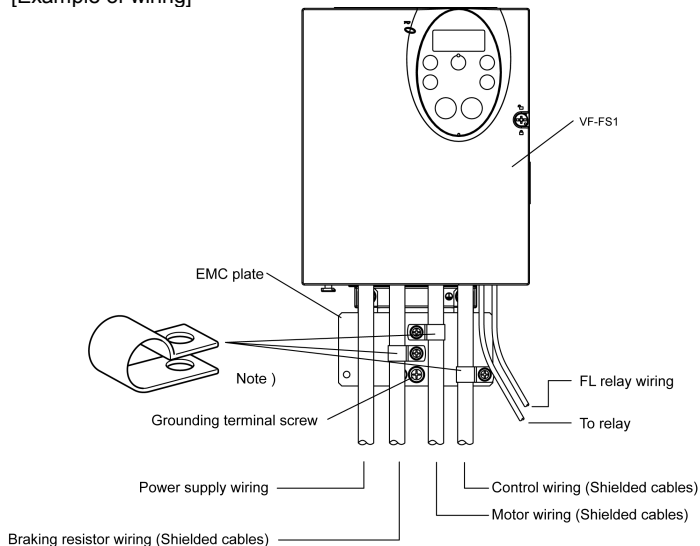

Note: Strip and earth the shielded cable, following the example shown in Fig.

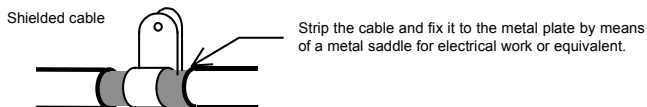

### 9.1.3 About the low-voltage directive

The low-voltage directive provides for the safety of machines and systems. All Toshiba inverters are CE-marked in accordance with the standard EN/IEC 61800-5-1 specified by the low-voltage directive, and can therefore be installed in machines or systems and imported without problem to European countries.

Applicable standard: EN/IEC 61800-5-1

Adjustable second electrical power drive system

## 9.1.4 Measures to satisfy the low-voltage directive

When incorporating the inverter into a machine or system, it is necessary to take the following measures so that the inverter satisfies the low-voltage directive.

- (1) Install the inverter in a cabinet and ground the inverter enclosure. When doing maintenance, be extremely careful not to put your fingers into the inverter through a wiring hole and touch a charged part, which may occur depending on the model and capacity of the inverter used.
- (2) Do not connect two or more wires to the main circuit earth terminal of the inverter. If necessary, install an additional earth terminal on the metal plate on which the inverter is installed and connect another cable to it. Or install the EMC plate (attached as standard) and another cable connect to earth terminal on the EMC plate. Refer to the table 10.1 for earth cable sizes.
- (3) Install a non-fuse circuit breaker or a fuse on the input side of the inverter.

## 9.2 Compliance with UL Standard and CSA Standard

The VF-FS1 models, that conform to the UL Standard and CSA Standard have the UL/CSA mark on the nameplate.

### 9.2.1 Compliance with Installation

The VF-FS1 inverter must be installed in a panel, and used within the ambient temperature specification.

⇒ See section 1.4.4.

### 9.2.2 Compliance with Connection

Use the UL conformed cables (Rating 75 °C or more) to the main circuit terminals (R/L1, S/L2, T/L3, U/T1, V/T2, W/T3).

For instruction in the United States, Integral solid state short circuit protection does not provide branch circuit protection. Branch circuit protection must be provided in accordance with the National Electrical Code and any additional local codes.

For instruction in the Canada, Integral solid state short circuit protection does not provide branch circuit protection. Branch circuit protection must be provided in accordance with the Canadian Electrical Code and any additional local codes.

Refer to the table of next page about wire sizes.

### 9.2.3 Compliance with Peripheral devices

Use the UL listed fuses at connecting to power supply.

Short circuit test is performed under the condition of the power supply short-circuit currents in below.

These interrupting capacities and fuse rating currents depend on the applicable motor capacities.

Input voltage	Drive motor	Power supply short-circuit and maximum input voltage
200V	Up to 4.0kW	Suitable For Use On A Circuit Capable Of Delivering Not More Than 5,000A rms Symmetrical Amperes, 240 Volts Maximum When Protected by J Class Fuses.
	5.5kW and over	Suitable For Use On A Circuit Capable Of Delivering Not More Than 22,000A rms Symmetrical Amperes, 240 Volts Maximum When Protected by J Class Fuses.
400V	Up to 4.0kW	Suitable For Use On A Circuit Capable Of Delivering Not More Than 5,000A rms Symmetrical Amperes, 480 Volts Maximum When Protected by J Class Fuses.
	5.5kW and over	Suitable For Use On A Circuit Capable Of Delivering Not More Than 22,000A rms Symmetrical Amperes, 480 Volts Maximum When Protected by J Class Fuses.



### ■ AIC, Fuse and Wire sizes

Voltage class	Capacity of applicable motor (kW)	Inverter model	AIC (A) (Interrupting capacity)	Fuse class and current (A)	Maximum input voltage (V)	Input wire sizes of power circuit	Out put wire sizes of power circuit	Earth
Three-phase 200V class	0.4	VFFS1-2004PM	AIC 5000A	J 3A max.	240	AWG 14	AWG 14	AWG 14
	0.75	VFFS1-2007PM	AIC 5000A	J 6A max.	240	AWG 14	AWG 14	AWG 14
	1.5	VFFS1-2015PM	AIC 5000A	J 10A max.	240	AWG 14	AWG 14	AWG 14
	2.2	VFFS1-2022PM	AIC 5000A	J 15A max.	240	AWG 14	AWG 14	AWG 14
	4.0	VFFS1-2037PM	AIC 5000A	J 25A max.	240	AWG 12	AWG 10	AWG 12
	5.5	VFFS1-2055PM	AIC 22000A	J 35A max.	240	AWG 10	AWG 8	AWG 10
	7.5	VFFS1-2075PM	AIC 22000A	J 45A max.	240	AWG 8	AWG 8	AWG 10
	11	VFFS1-2110PM	AIC 22000A	J 70A max.	240	AWG 6	AWG 6	AWG 10
	15	VFFS1-2150PM	AIC 22000A	J 90A max.	240	AWG 4	AWG 4	AWG 10
	18.5	VFFS1-2185PM	AIC 22000A	J 100 A max.	240	AWG 4	AWG 3	AWG 8
Three-phase 400V class	0.4	VFFS1-4004PL	AIC 5000A	J 3A max.	480	AWG 14	AWG 14	AWG 14
	0.75	VFFS1-4007PL	AIC 5000A	J 3A max.	480	AWG 14	AWG 14	AWG 14
	1.5	VFFS1-4015PL	AIC 5000A	J 6A max.	480	AWG 14	AWG 14	AWG 14
	2.2	VFFS1-4022PL	AIC 5000A	J 10A max.	480	AWG 14	AWG 14	AWG 14
	4.0	VFFS1-4037PL	AIC 5000A	J 15A max.	480	AWG 14	AWG 14	AWG 14
	5.5	VFFS1-4055PL	AIC 22000A	J 20A max.	480	AWG 14	AWG 14	AWG 14
	7.5	VFFS1-4075PL	AIC 22000A	J 25A max.	480	AWG 12	AWG 12	AWG 14
	11	VFFS1-4110PL	AIC 22000A	J 35A max.	480	AWG 10	AWG 10	AWG 10
	15	VFFS1-4150PL	AIC 22000A	J 45A max.	480	AWG 8	AWG 8	AWG 10
	18.5	VFFS1-4185PL	AIC 22000A	J 60A max.	480	AWG 8	AWG 8	AWG 10
	22	VFFS1-4220PL	AIC 22000A	J 70A max.	480	AWG 6	AWG 6	AWG 10
	30	VFFS1-4300PL	AIC 22000A	J 90A max.	480	AWG 4	AWG 4	AWG 10
	37	VFFS1-4370PL	AIC 22000A	J 110A max.	480	AWG 3	AWG 3	AWG 8
	45	VFFS1-4450PL	AIC 22000A	J 125A max.	480	AWG 2	AWG 1	AWG 8
55	VFFS1-4550PL	AIC 22000A	J 175A max.	480	AWG 1	AWG 1/0	AWG 6	
75	VFFS1-4750PL	AIC 22000A	J 225A max.	480	AWG 3/0	AWG 3/0	AWG 6	

## 9.2.4 Motor thermal protection

Selects the electronic thermal protection characteristics that fit with the ratings and characteristics of the motor. In case of multi motor operation with one inverter, thermal relay should be connected to each motor.

## 10. Peripheral devices

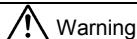

Warning



Mandatory

- When using switchgear for the inverter, it must be installed in a cabinet. Failure to do so can lead to risk of electric shock and can result in death or serious injury.



Be Grounded

- Connect earth cables securely. Failure to do so can lead to risk of electric shock or fire in case of a failure or short-circuit or electric leak.

### 10.1 Selection of wiring materials and devices

Voltage class	Capacity of applicable motor (kW)	Inverter model	Wire size (See Note 4)			
			Power circuit (mm <sup>2</sup> ) Note 1		Earth cable (mm <sup>2</sup> )	
			For IEC60364-5-523/54, IEC60204-1	For JAPAN JEAC8001-2005	For IEC60364-5-523/54, IEC60204-1	For JAPAN JEAC8001-2005
Three-phase 200V class	0.4	VFFS1-2004PM	1.5	2	2.5	2
	0.75	VFFS1-2007PM	1.5	2	2.5	2
	1.5	VFFS1-2015PM	1.5	2	2.5	2
	2.2	VFFS1-2022PM	1.5	2	2.5	2
	4.0	VFFS1-2037PM	2.5	2	2.5	2
	5.5	VFFS1-2055PM	4	3.5	4	3.5
	7.5	VFFS1-2075PM	6	5.5	6	3.5
	11	VFFS1-2110PM	10	14	10	5.5
	15	VFFS1-2150PM	16	14	16	5.5
	18.5	VFFS1-2185PM	25	22	16	8
	22	VFFS1-2220PM	25	38	16	8
30	VFFS1-2300PM	50	38	25	14	
Three-phase 400V class	0.4	VFFS1-4004PL	1.5	2	2.5	2
	0.75	VFFS1-4007PL	1.5	2	2.5	2
	1.5	VFFS1-4015PL	1.5	2	2.5	2
	2.2	VFFS1-4022PL	1.5	2	2.5	2
	4.0	VFFS1-4037PL	1.5	2	2.5	2
	5.5	VFFS1-4055PL	1.5	2	2.5	2
	7.5	VFFS1-4075PL	1.5	2	2.5	2
	11	VFFS1-4110PL	4	3.5	4	3.5
	15	VFFS1-4150PL	6	5.5	6	3.5
	18.5	VFFS1-4185PL	6	5.5	6	5.5
	22	VFFS1-4220PL	10	8	10	5.5
	30	VFFS1-4300PL	16	14	16	5.5
	37	VFFS1-4370PL	25	22	16	8
	45	VFFS1-4450PL	35	38	16	8
	55	VFFS1-4550PL	50	38	25	6
75	VFFS1-4750PL	70	60	35	6	

Note 1: Sizes of the wires connected to the input terminals R/L1, S/L2 and T/L3 and the output terminals U/T1, V/T2 and W/T3 when the length of each wire does not exceed 30m.

Note 2: For the control circuit, use shielded wires 0.75 mm<sup>2</sup> or more in diameter.

Note 3: For grounding, use a cable with a size equal to or larger than the above.

- Note 4: For IEC, the wire sizes specified in the above table apply to PVC wires (copper wires shielded with an insulator with a maximum allowable temperature of 70°C) used at an ambient temperature of 40°C or less  
 For Japan, the wire sizes specified in the above table apply to HIV wires (copper wires shielded with an insulator with a maximum allowable temperature of 75°C) used at an ambient temperature of 40°C or less.
- Note 5: If there is a need to bring the inverter into UL compliance, use wires specified in Chapter 9.

**■ Selection of wiring devices**

Voltage class	Capacity of applicable motor (kW)	Input current (A)		Inverter model	Molded case circuit breaker (MCCB) Earth leakage circuit breaker (ELCB)	Magnetic contactor (MC)
		200V class:200V 400V class:380V	200V class:240V 400V class:480V		Rated current (A)	Operational current(A) AC-1
Three-phase 200V class	0.4	1.9	1.6	VFFS1-2004PM	3	25
	0.75	3.3	2.7	VFFS1-2007PM	5	25
	1.5	6.1	5.1	VFFS1-2015PM	10	25
	2.2	8.7	7.3	VFFS1-2022PM	15	25
	4	15.7	13.0	VFFS1-2037PM	30	25
	5.5	20.8	17.3	VFFS1-2055PM	40	32
	7.5	27.9	23.3	VFFS1-2075PM	50	40
	11	42.1	34.4	VFFS1-2110PM	75	50
	15	56.1	45.5	VFFS1-2150PM	100	80
	18.5	67.3	55.8	VFFS1-2185PM	100	80
	22	80.4	66.4	VFFS1-2220PM	125	100
	30	113.3	89.5	VFFS1-2300PM	175	125
	Three-phase 400V class Note 4)	0.4	1.0	0.8	VFFS1-4004PL	3
0.75		1.7	1.4	VFFS1-4007PL	3	25
1.5		3.2	2.5	VFFS1-4015PL	5	25
2.2		4.6	3.6	VFFS1-4022PL	10	25
4		8.1	6.4	VFFS1-4037PL	15	25
5.5		10.9	8.6	VFFS1-4055PL	20	25
7.5		14.7	11.7	VFFS1-4075PL	30	32
11		21.1	16.8	VFFS1-4110PL	40	32
15		28.5	22.8	VFFS1-4150PL	50	40
18.5		34.8	27.8	VFFS1-4185PL	60	50
22		41.6	33.1	VFFS1-4220PL	75	80
30		56.7	44.7	VFFS1-4300PL	100	80
37		84	69	VFFS1-4370PL	100	100
45		104	85	VFFS1-4450PL	125	125
55		120	101	VFFS1-4550PL	150	125
75	167	137	VFFS1-4750PL	200	250	

- Note 1: Selections for use of the Toshiba 4-pole standard motor with power supply voltage of 200V/400V-50Hz.  
 Note 2: Choose the MCCB according to the power supply capacity.

For comply with UL and CSA standard, use the fuse certified by UL and CSA.

- Note 3: When using on the motor side during commercial-power supply operation, choose the MC with class AC-3 rated current for the motor rated current.  
 Note 4: Attach surge killers to the magnetic contactor and exciting coil of the relay.  
 Note 5: In the case the magnetic contactor (MC) with 2a-type auxiliary contacts is used for the control circuit, raise the reliability of the contact by using 2a-type contacts in parallel connection.

## 10.2 Installation of a magnetic contactor

If using the inverter without installing a magnetic contactor (MC) in the primary circuit, use an MCCB (with a power cutoff device) to open the primary circuit when the inverter protective circuit is activated.

### ■ Magnetic contactor in the primary circuit

To detach the inverter from the power supply in any of the following cases, insert a magnetic contactor (primary-side magnetic contactor) between the inverter and the power supply.

- (1) If the motor overload relay is tripped
- (2) If the protective detector (FL) built into the inverter is activated
- (3) In the event of a power failure (for prevention of auto-restart)

When using the inverter with no magnetic contactor (MC) on the primary side, install a non-fuse circuit breaker with a voltage tripping coil instead of an MC and adjust the circuit breaker so that it will be tripped if the protective relay referred to above is activated. To detect a power failure, use an undervoltage relay or the like.

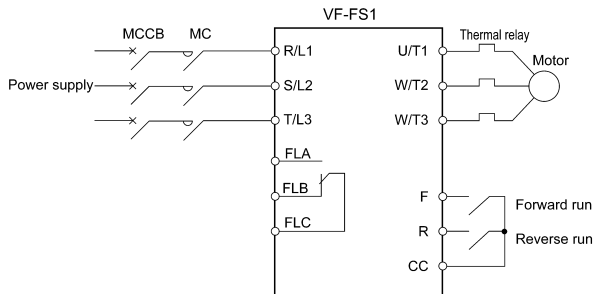

Example of connection of a magnetic contactor in the primary circuit

### Notes on wiring

- When frequently switching between start and stop, do not use the magnetic contactor on the primary side as an on-off switch for the inverter. Instead, stop and start the inverter by using terminals F and CC (forward run) or R and CC (reverse run).
- Be sure to attach a surge killer to the exciting coil of the magnetic contactor (MC).

## ■ Magnetic contactor in the secondary circuit

A magnetic contactor may be installed on the secondary side to switch controlled motors or supply commercial power to the load when the inverter is out of operation.

### Notes on wiring

- Be sure to interlock the magnetic contactor on the secondary side with the power supply to prevent commercial power from being applied to the inverter output terminals.
- When installing a magnetic contactor (MC) between the inverter and the motor, avoid turning the magnetic contactor on or off during operation. Turning the magnetic contactor on or off during operation causes a current to rush into the inverter which could lead to malfunction.

## 10.3 Installation of an overload relay

---

- 1) The VF-FS1 inverter has an electronic-thermal overload protective function.  
In the following cases, however, an overload relay suitable for the adjustment of the motor electronic thermal protection level ( $I_{tr}$ ) and appropriate to the motor used should be installed between the inverter and the motor.
  - When using a motor with a current rating different to that of the corresponding Toshiba general-purpose motor
  - When operating a single motor with an output smaller than that of the applicable standard motor or more than one motor simultaneously.
- 2) When using the VF-FS1 inverter to operate a constant-torque motor, such as the Toshiba VF motor, adjust the protection characteristic of the electronic thermal protection unit ( $I_{tr}$ ) to the VF motor use.
- 3) It is recommended to use a motor with a thermal relay embedded in the motor coil to give sufficient protection to the motor, especially when it runs in a low-speed range.

## 10.4 Optional external devices

The following external devices are optionally available for the VF-FS1 series of inverters.

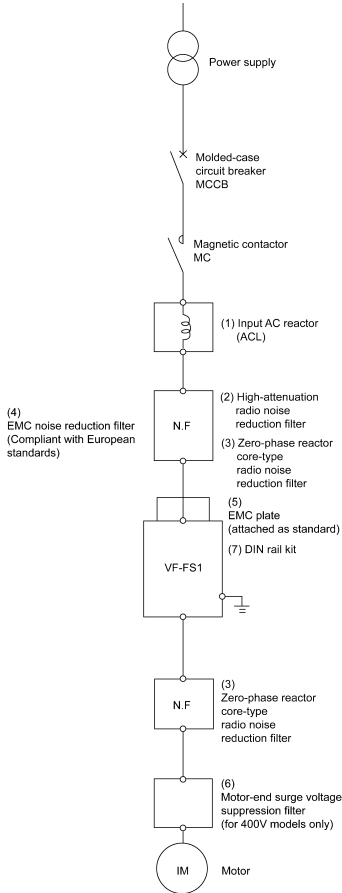

- (8) Parameter writer
- (9) Extension panel
- (10) Internal LonWorks® communication circuit board
- (11) Internal Metasys® N2 communication circuit board
- (12) Internal Siemens APOGEE™ FLN communication circuit board
- (13) Internal BACnet® communication circuit board
- (14) USB communication converter unit
- (15) Operational panel
- (16) Conduit pipe attachment kit

# 11. Table of parameters and data

## 11.1 User parameters

Title	Function	Unit	Minimum setting unit Panel/Communication	Adjustment range	Default setting	User setting	Reference
<i>F<math>\bar{C}</math></i>	Operation frequency of operation panel	Hz	0.1/0.01	$L-L-U-L$ When the value of $F\bar{7}Q\bar{3}$ is 1, this range is from $0.0$ to the value of $F\bar{H}$ with free-unit.	0.0		3.2

## 11.2 Basic parameters

Title	Communication No.	Function	Unit	Minimum setting unit Panel/Communication	Adjustment range	Default setting	User setting	Reference
<i>RUF</i>	-	Wizard function	-	-	The wizard function refers to the special function of calling up ten frequently used parameters.	-		4.2.4 6.20.7
<i>RUH</i>	-	History function	-	-	Displays parameters in groups of five in the reverse order to that in which their settings were changed. * (Possible to edit)	-		4.2.5
<i>RU1</i>	0000	Automatic acceleration/ deceleration	-	-	0: Disabled (manual) 1: Automatic 2: Automatic (only at acceleration)	0		5.1.1
<i>RU4</i>	0040	Parameter setting macro function	-	-	0: Disabled 1: Coast stop 2: 3-wire operation 3: External input UP/DOWN setting 4: 4-20 mA current input operation	0		5.2
<i>CRQd</i>	0003	Command mode selection	-	-	0: Terminal board 1: Operation panel 2: RS485 communication	0		5.3 7.2
<i>FRQd</i>	0004	Frequency setting mode selection 1	-	-	1: VIA 2: VIB 3: Operation panel 4: RS485 communication 5: UP/DOWN from external contact	1		5.3 6.5.1 7.1

Title	Communication No.	Function	Unit	Minimum setting unit Panel/Communication	Adjustment range	Default setting	User setting	Reference
<i>F<math>\bar{r}</math>SL</i>	0005	Meter selection	-	-	0: Output frequency 1: Output current 2: Set frequency 3: DC voltage 4: Output voltage command value 5: Input power 6: Output power 7: Torque 8: Torque current 9: Motor cumulative load factor 10: Inverter cumulative load factor 11: - (do not select) 12: Frequency setting value (after PID) 13: VIA Input value 14: VIB Input value 15: Fixed output 1 (Output current: 100%) 16: Fixed output 2 (Output current: 50%) 17: Fixed output 3 (Supposition output at <i>F<math>\bar{r}</math>SL</i> = 17) 18: RS485 communication data 19: For adjustments ( <i>F<math>\bar{r}</math></i> set value is displayed.)	0		5.4
<i>F<math>\bar{r}</math></i>	0006	Meter adjustment	-	-	-	-		
<i>LSP</i>	0007	Default setting	-	-	0: - 1: 50Hz default setting 2: 60Hz default setting 3: Default setting (Initialization) 4: Trip record clear 5: Cumulative operation time clear 6: Initialization of type information 7: Save user setting parameters 8: Call user-defined parameters 9. Cumulative fan operation time record clear	0		4.2.7 4.2.8 5.5
<i>F<math>\bar{r}</math></i>	0008	Forward/reverse run selection (Operation panel operation)	-	-	0: Forward run 1: Reverse run 2: Forward run ( <i>F/R</i> switching possible) 3: Reverse run ( <i>F/R</i> switching possible)	0		5.6
<i>ACC</i>	0009	Acceleration time 1	S	0.1/0.1	0.0-3200	*2		5.1.2
<i>DEC</i>	0010	Deceleration time 1	S	0.1/0.1	0.0-3200	*2		
<i>FH</i>	0011	Maximum frequency	Hz	0.1/0.01	30.0-200.0	80.0		5.7
<i>UL</i>	0012	Upper limit frequency	Hz	0.1/0.01	0.5- <i>FH</i>	50.0 (WP) 60.0 (WN)		5.8
<i>LL</i>	0013	Lower limit frequency	Hz	0.1/0.01	0.0- <i>UL</i>	0.0		
<i>ωL</i>	0014	Base frequency 1	Hz	0.1/0.01	25.0-200.0	50.0 (WP) 60.0 (WN)		5.9
<i>ωLω</i>	0409	Base frequency voltage 1	V	1/0.1	50-330 (200V class) 50-660 (400V class)	*1		5.9 6.12.5



Title	Communication No.	Function	Unit	Minimum setting unit Panel/Communication	Adjustment range	Default setting	User setting	Reference																														
$\rho \epsilon$	0015	V/F control mode selection	-	-	0: V/F constant 1: Variable torque 2: Automatic torque boost control 3: Vector control 4: Advanced energy-saving 5: - (Do not select) 6: PM motor control	1		5.10																														
$u b$	0016	Torque boost 1	%	0.1/0.1	0.0-30.0	* 2		5.11																														
$\epsilon H r$	0600	Motor electronic-thermal protection level 1	% (A)	1/1	10-100	100		5.12 6.17.1																														
$\theta L \#$	0017	Electronic-thermal protection characteristic selection *3	-	-	<table border="1"> <thead> <tr> <th>Setting</th> <th></th> <th>Overload protection</th> <th>OL stall</th> </tr> </thead> <tbody> <tr> <td>0</td> <td rowspan="4">Standard motor</td> <td>○</td> <td>○</td> </tr> <tr> <td>1</td> <td>○</td> <td>○</td> </tr> <tr> <td>2</td> <td>×</td> <td>×</td> </tr> <tr> <td>3</td> <td>×</td> <td>○</td> </tr> <tr> <td>4</td> <td rowspan="4">VF motor</td> <td>○</td> <td>×</td> </tr> <tr> <td>5</td> <td>○</td> <td>○</td> </tr> <tr> <td>6</td> <td>×</td> <td>×</td> </tr> <tr> <td>7</td> <td>×</td> <td>○</td> </tr> </tbody> </table>	Setting		Overload protection	OL stall	0	Standard motor	○	○	1	○	○	2	×	×	3	×	○	4	VF motor	○	×	5	○	○	6	×	×	7	×	○	0		5.12
Setting		Overload protection	OL stall																																			
0	Standard motor	○	○																																			
1		○	○																																			
2		×	×																																			
3		×	○																																			
4	VF motor	○	×																																			
5		○	○																																			
6		×	×																																			
7		×	○																																			
$S r 1$	0018	Preset-speed operation frequency 1	Hz	0.1/0.01	$L L - U L$	15.0		5.13																														
$S r 2$	0019	Preset-speed operation frequency 2	Hz	0.1/0.01	$L L - U L$	20.0																																
$S r 3$	0020	Preset-speed operation frequency 3	Hz	0.1/0.01	$L L - U L$	25.0																																
$S r 4$	0021	Preset-speed operation frequency 4	Hz	0.1/0.01	$L L - U L$	30.0																																
$S r 5$	0022	Preset-speed operation frequency 5	Hz	0.1/0.01	$L L - U L$	35.0																																
$S r 6$	0023	Preset-speed operation frequency 6	Hz	0.1/0.01	$L L - U L$	40.0																																
$S r 7$	0024	Preset-speed operation frequency 7	Hz	0.1/0.01	$L L - U L$	45.0																																
$F - - -$	-	Extended parameters	-	-	-	-	-	4.2.2																														
$\bar{G} r . U$	-	Automatic edit function	-	-	-	-	-	4.2.3																														

\*1 : 230 (WP/WN type), 400 (WP type), 460 (WN type)

\*2 : Default values vary depending on the capacity. ⇒ See the table of page K-14.

\*3 : ○ : valid, × : invalid

## 11.3 Extended parameters

### • Input/output parameters 1

Title	Communication No.	Function	Unit	Minimum setting unit Panel/Communication	Adjustment range	Default setting	User setting	Reference
F 100	0100	Low-speed signal output frequency	Hz	0.1/0.01	0.0- <i>F H</i>	0.0		6.1.1
F 101	0101	Speed reach setting frequency	Hz	0.1/0.01	0.0- <i>F H</i>	0.0		6.1.3
F 102	0102	Speed reach detection band	Hz	0.1/0.01	0.0- <i>F H</i>	2.5		6.1.2
F 108	0108	Always active function selection 1	-	-	0-72 (No function)	0		6.3.1
F 109	0109	Analog/contact input function selection (VIA terminal)	-	-	0: VIA - analog input 1: VIA - contact input (Sink) 2: VIA - contact input (Source)	0		6.2.1
F 110	0110	Always-active function selection 2	-	-	0-72 (ST)	1		6.3.1
F 111	0111	Input terminal selection 1 (F)	-	-	0-72 (F)	2		6.3.2
F 112	0112	Input terminal selection 2 (R)	-	-	0-72 (R)	3		
F 113	0113	Input terminal selection 3 (RES)	-	-	0-72 (RES)	10		
F 118	0118	Input terminal selection 8 (VIA)	-	-	0-72 (SS1)	6		
F 130	0130	Output terminal selection 1A (RY-RC)	-	-	0-255 (LOW)	4		6.3.3
F 132	0132	Output terminal selection 3 (FL)	-	-	0-255 (FL)	10		
F 137	0137	Output terminal selection 1B (RY-RC)	-	-	0-255 (always ON)	255		6.3.4
F 139	0139	Output terminal logic selection (RY-RC)	-	-	0: <i>F 130</i> and <i>F 137</i> 1: <i>F 130</i> or <i>F 137</i>	0		
F 146	0146	Delay time for RY-RC relay	s	0.1/0.1	0.0-60.0	0.0		6.3.5
F 147	0147	Delay time for FL relay	s	0.1/0.1	0.0-60.0	0.0		
F 160	0160	Analog VIA detection level	%	1/1	0-100	0		6.3.6
F 161	0161	Analog VIA detection band	%	1/1	0-20	3		
F 162	0162	Analog VIB detection level	%	1/1	0-100	0		
F 163	0163	Analog VIB detection band	%	1/1	0-20	3		
F 167	0167	Frequency command agreement detection range	Hz	0.1/0.01	0.0- <i>F H</i>	2.5		6.3.7
F 170	0170	Base frequency 2	Hz	0.1/0.01	25.0-200.0	50.0 (WP) 60.0 (WN)		6.4.1
F 171	0171	Base frequency voltage 2	V	1/0.1	50-330 (200V class) 50-660 (400V class)	* 2		
F 172	0172	Torque boost 2	%	0.1/0.1	0.0-30.0	* 1		

\*1 : Default values vary depending on the capacity. ⇒ See the table of page K-14.

\*2 : 230 (WP/WN type), 400 (WP type), 460 (WN type)

• Frequency parameters

Title	Communication No.	Function	Unit	Minimum setting unit Panel/Communication	Adjustment range	Default setting	User setting	Reference
F173	0173	Motor electronic-thermal protection level 2	% (A)	1/1	10-100	100		5.12 6.4.1
F185	0185	Stall prevention level 2	% (A)	1/1	10-110	110		6.4.1 6.17.2
F200	0200	Frequency priority selection	-	-	0: F <sub>100</sub> (Switchable to F <sub>200</sub> by terminal input) 1: F <sub>100</sub> (Switchable to F <sub>200</sub> at less than 1.0Hz of designated frequency)	0		6.5.1 7.1
F201	0201	VIA input point 1 setting	%	1/1	0-100	0		6.5.2
F202	0202	VIA input point 1 frequency	Hz	0.1/0.01	0.0-200.0	0.0		
F203	0203	VIA input point 2 setting	%	1/1	0-100	100		
F204	0204	VIA input point 2 frequency	Hz	0.1/0.01	0.0-200.0	50.0 (WP) 60.0 (WN)		
F207	0207	Frequency setting mode selection 2	-	-	1: VIA 2: VIB 3: Operation panel 4: RS485 communication 5: UP/DOWN from external contact	2		6.3.7 6.5.1 7.1
F210	0210	VIB input point 1 setting	%	1/1	0-100	0		6.5.2
F211	0211	VIB input point 1 frequency	Hz	0.1/0.01	0.0-200.0	0.0		
F212	0212	VIB input point 2 setting	%	1/1	0-100	100		
F213	0213	VIB input point 2 frequency	Hz	0.1/0.01	0.0-200.0	50.0 (WP) 60.0 (WN)		
F240	0240	Starting frequency setting	Hz	0.1/0.01	0.5-10.0	0.5		
F241	0241	Operation starting frequency	Hz	0.1/0.01	0.0-F <sub>H</sub>	0.0		
F242	0242	Operation starting frequency hysteresis	Hz	0.1/0.01	0.0-F <sub>H</sub>	0.0		
F250	0250	DC braking starting frequency	Hz	0.1/0.01	0.0-F <sub>H</sub>	0.0		6.7.1
F251	0251	DC braking current	%(A)	1/1	0-100	50		
F252	0252	DC braking time	s	0.1/0.1	0.0-20.0	1.0		
F256	0256	Auto-stop in case of lower-limit frequency continuous operation time	s	0.1/0.1	0.0: Disabled 0.1-600.0	0.0		6.8
F264	0264	External contact input - UP response time	s	0.1/0.1	0.0-10.0	0.1		6.5.3
F265	0265	External contact input - UP frequency steps	Hz	0.1/0.01	0.0-F <sub>H</sub>	0.1		

Title	Communication No.	Function	Unit	Minimum setting unit Panel/Communication	Adjustment range	Default setting	User setting	Reference	
F266	0266	External contact input - DOWN response time	s	0.1/0.1	0.0-10.0	0.1		6.5.3	
F267	0267	External contact input - DOWN frequency steps	Hz	0.1/0.01	0.0-FH	0.1			
F268	0268	Initial UP/DOWN frequency	Hz	0.1/0.01	LL - UL	0.0			
F269	0269	Change of the initial up/down frequency	-	-	0: Not changed 1: Setting of F268 changed when power is turned off	1			
F270	0270	Jump frequency 1	Hz	0.1/0.01	0.0-FH	0.0		6.9	
F271	0271	Jumping width 1	Hz	0.1/0.01	0.0-30.0	0.0			
F272	0272	Jump frequency 2	Hz	0.1/0.01	0.0-FH	0.0			
F273	0273	Jumping width 2	Hz	0.1/0.01	0.0-30.0	0.0			
F274	0274	Jump frequency 3	Hz	0.1/0.01	0.0-FH	0.0			
F275	0275	Jumping width 3	Hz	0.1/0.01	0.0-30.0	0.0			
F294	0294	Forced fire-speed setting frequency	Hz	0.1/0.01	LL - UL	50.0			6.18
F295	0295	Bumpless operation selection	-	-	0: Disabled 1: Enabled	1			6.10

• Operation mode parameters

Title	Communication No.	Function	Unit	Minimum setting unit Panel/Communication	Adjustment range	Default setting	User setting	Reference
F300	0300	PWM carrier frequency	kHz	0.1/0.1	6.0 - 16.0	* 1		6.11
F301	0301	Auto-restart control selection	-	-	0: Disabled 1: At auto-restart after momentary stop 2: When turning ST-CC on or off 3: At auto-restart or when turning ST-CC on or off 4: At start-up	0		6.12.1
F302	0302	Instantaneous power failure coast stop selection	-	-	0: Disabled 1: - (Do not select) 2: Coast stop	0		
F303	0303	Retry selection (number of times)	Times	1/1	0: Disabled 1-10	0		6.12.3
F305	0305	Overvoltage limit operation (Slowdown stop mode selection)	-	-	0: Enabled 1: Disabled 2: Enabled (Quick deceleration) 3: Enabled (Dynamic quick deceleration)	2		6.12.4

Title	Communication	Function	Unit	Minimum setting unit Panel/Communication	Adjustment range	Default setting	User setting	Reference
F307	0307	Supply voltage correction (limitation of output voltage)	-	-	0: Supply voltage uncorrected, output voltage limited 1: Supply voltage corrected, output voltage limited 2: Supply voltage uncorrected, output voltage unlimited 3: Supply voltage corrected, output voltage unlimited	3		6.12.5
F311	0311	Reverse-run prohibition	-	-	0: Forward/reverse run permitted 1: Reverse run prohibited 2: Forward run prohibited	0		6.12.6
F312	0312	Random mode	-	-	0: Disabled 1: Automatic setting	0		6.11
F316	0316	Carrier frequency control mode selection	-	-	0: Carrier frequency not reduced automatically 1: Carrier frequency reduced automatically 2: Carrier frequency not reduced automatically Support for 400V models 3: Carrier frequency reduced automatically Support for 400V models	1		
F320	0320	Drop gain	%	1/1	0-100	0		6.13
F323	0323	Drop insensitive torque band	%	1/1	0-100	10		
F359	0359	PID control waiting time	s	1/1	0-2400	0		6.14
F360	0360	PID control	-	-	0: Disabled, 1: Enabled (Feedback: VIA) 2: Enabled (Feedback: VIB)	0		
F362	0362	Proportional gain	-	0.01/0.01	0.01-100.0	0.30		
F363	0363	Integral gain	-	0.01/0.01	0.01-100.0	0.20		
F366	0366	Differential gain	-	0.01/0.01	0.00-2.55	0.00		
F380	0380	PID forward / reverse characteristic selection	-	1/1	0: Forward (Standard) 1: Reverse	0		
F391	0391	Hysteresis for LL stop operation	Hz	0.1/0.01	0.0-F H	0.2		6.8.1
F392	0392	Restart deviation for LL stop operation	Hz	0.1/0.01	0.0-F H	0.0		
F393	0393	Restart feedback for LL stop operation	Hz	0.1/0.01	0.0-F H	0.0		

\*1 : Default values vary depending on the capacity. ⇒ See the table of page K-14.

• Torque boost parameters 1

Title	Communication No.	Function	Unit	Minimum setting unit Panel/Communication	Adjustment range	Default setting	User setting	Reference
F400	0400	Auto-tuning	-	-	0: Auto-tuning disabled 1: Application of individual settings of F402 (after execution: 0) 2: Auto-tuning enabled (after execution: 0)	0		5.10 6.15.1
F401	0401	Slip frequency gain	%	1/1	0-150	50		
F402	0402	Automatic torque boost value	%	0.1/0.1	0.0-30.0	*1		
F415	0415	Motor rated current	A	0.1/0.1	0.1-200.0	*1		
F416	0416	Motor no-load current	%	1/1	10-100	*1		
F417	0417	Motor rated speed	min-1	1/1	100-15000	*1		
F418	0418	Speed control response coefficient	-	1/1	1-150	40		
F419	0419	Speed control stability coefficient	-	1/1	1-100	20		

\*1 : Default values vary depending on the capacity. ⇒ See the table of page K-14.

• Input/output parameters 2

Title	Communication No.	Function	Unit	Minimum setting unit Panel/Communication	Adjustment range	Default setting	User setting	Reference
F470	0470	VIA input bias	-	-	0-255	128		6.5.4
F471	0471	VIA input gain	-	-	0-255	148		
F472	0472	VIB input bias	-	-	0-255	128		
F473	0473	VIB input gain	-	-	0-255	148		

• Torque boost parameters 2

Title	Communication No.	Function	Unit	Minimum setting unit Panel/Communication	Adjustment range	Default setting	User setting	Reference
F480	0480	Exciting current coefficient	%	1/1	100-130	100		5.10 6.15.2 6.17.16
F481	0481	Power supply compensation filter	-	1/1	0-9999	0		
F482	0482	Inhibitor filter	-	1/1	0-9999	442		
F483	0483	Inhibitor gain	-	0.1/0.1	0.0-300.0	100.0		
F484	0484	Power supply adjustment gain	-	0.1/0.1	0.0 : Disable 0.1~2.0	0.0		
F485	0485	Stall prevention control coefficient 1	-	1/1	10-250	100		
F492	0492	Stall prevention control coefficient 2	-	1/1	50-150	100		
F494	0494	Motor adjustment coefficient	-	1/1	0-200	*1		

Title	Communication No.	Function	Unit	Minimum setting unit Panel/Communication	Adjustment range	Default setting	User setting	Reference
F495	0495	Maximum voltage adjustment coefficient	%	1/1	90-120	104		5.10 6.15.2
F496	0496	Waveform switching adjustment coefficient	kHz	0.1/0.1	0.1-14.0	14.0		

\*1 : Default values vary depending on the capacity. ⇒ See the table of page K-14.

#### • Acceleration/deceleration time parameters

Title	Communication No.	Function	Unit	Minimum setting unit Panel/Communication	Adjustment range	Default setting	User setting	Reference
F500	0500	Acceleration time 2	s	0.1/0.1	0.0-3200	* 1		6.16
F501	0501	Deceleration time 2	s	0.1/0.1	0.0-3200	* 1		
F502	0502	Acceleration/deceleration 1 pattern	-	-	0: Linear 1: S-pattern 1	0		
F503	0503	Acceleration/deceleration 2 pattern	-	-	2: S-pattern 2	0		
F504	0504	Selecting an acceleration/deceleration pattern	-	-	1: Acceleration/deceleration 1 2: Acceleration/deceleration 2	1		
F505	0505	Acceleration/deceleration 1 and 2 switching frequency	Hz	0.1/0.01	0.0-UL	0.0		
F506	0506	S-pattern lower-limit adjustment amount	%	1/1	0-50	10		
F507	0507	S-pattern upper-limit adjustment amount	%	1/1	0-50	10		

\*1 : Default values vary depending on the capacity. ⇒ See the table of page K-14.

#### • Protection parameters

Title	Communication No.	Function	Unit	Minimum setting unit Panel/Communication	Adjustment range	Default setting	User setting	Reference
F601	0601	Stall prevention level 1	% (A)	1/1	10-110	110		6.17.2
F602	0602	Inverter trip retention selection	-	-	0: Canceled with the power off 1: Still retained with the power off	0		6.17.3
F603	0603	Emergency stop selection	-	-	0: Coast stop 1: Slowdown stop 2: Emergency DC braking	0		6.17.4
F604	0604	Emergency DC braking time	s	0.1/0.1	0.0-20.0	1.0		
F605	0605	Output phase failure detection mode selection	-	-	0: Disabled 1: At start-up (only one time after power is turned on) 2: At start-up (each time) 3: During operation 4: At start-up + during operation 5: Detection of cutoff on output side	0		6.17.5
F607	0607	Motor 150%-overload time limit	s	1/1	10-2400	300		6.17.1
F608	0608	Input phase failure detection mode selection	-	-	0: Disabled, 1: Enabled	1		6.17.6

Title	Communication No.	Function	Unit	Minimum setting unit Panel/Communication	Adjustment range	Default setting	User setting	Reference
F609	0609	Small current detection current hysteresis	%	1/1	1-20	10		6.17.7
F610	0610	Small current trip/alarm selection	-	-	0: Alarm only 1: Tripping	0		
F611	0611	Small current detection current	% (A)	1/1	0-100	0		
F612	0612	Small current detection time	s	1/1	0-255	0		
F613	0613	Detection of output short-circuit during start-up	-	-	0: Each time (standard pulse) 1: Only one time after power is turned on (standard pulse) 2: Each time (short-time pulse) 3: Only one time after power is turned on (short-time pulse)	0		6.17.8
F615	0615	Over-torque trip/alarm selection	-	-	0: Alarm only 1: Tripping	0		6.17.9
F616	0616	Over-torque detection level	%	1/1	0-250	130		
F618	0618	Over-torque detection time	s	0.1/0.1	0.0-10.0	0.5		
F619	0619	Over-torque detection level hysteresis	%	1/1	0-100	10		
F621	0621	Cumulative operation time alarm setting	100 Time	0.1/0.1 (=10 hours)	0.0-999.9	610.0		6.17.10
F626	0626	Overvoltage limit operation level	%	1/1	100-150	140		6.12.4
F627	0627	Undervoltage trip/alarm selection	-	-	0: Alarm only (detection level below 60%) 1: Tripping (detection level below 60%) 2: Alarm only (detection level below 50%, input reactor necessary)	0		6.17.12
F632	0632	Thermal memory selection	-	-	0: Disabled 1: Enabled	0		6.17.1
F633	0633	Trip at VIA low level input mode	%	1/1	0: Disabled, 1-100	0		6.17.13
F634	0634	Annual average ambient temperature (For parts replacement alarms)	-	-	1: -10 to +10°C 2: 11-20°C 3: 21-30°C 4: 31-40°C 5: 41-50°C 6: 51-60°C	3		6.17.14
F644	0644	Action in the event of V/II analogue input wire breakage	-	1/1	0: Coast stop (Trip mode $\bar{E} - 1\bar{B}$ ) 1: Coast stop (Alarm mode $R\bar{L}\bar{O}5$ ) 2: Fallback speed (Alarm mode $R\bar{L}\bar{O}5$ ) 3: Speed maintain (Alarm mode $R\bar{L}\bar{O}5$ ) 4: Slowdown stop (Alarm mode $R\bar{L}\bar{O}5$ )	0		6.17.13
F645	0645	PTC thermal selection	-	-	0: Disabled 1: Enabled (trip mode) 2: Enabled (alarm mode)	0		6.17.15
F646	0646	PTC detection resistor value	$\Omega$	1/1	100-9999	3000		
F649	0649	Fallback speed	-	-	0-FH	0.0		6.17.13
F650	0650	Forced fire-speed control selection	-	-	0: Disabled 1: Enabled	0		6.18



• Output parameters

Title	Communication No.	Function	Unit	Minimum setting unit Panel/Communication	Adjustment range	Default setting	User setting	Reference
F 6 9 1	0691	Inclination characteristic of analog output	-	-	0: Negative inclination (downward slope) 1: Positive inclination (upward slope)	1		6.19.1
F 6 9 2	0692	Bias of analog output	%	1/1	0-100	0		

• Operation panel parameters

Title	Communication No.	Function	Unit	Minimum setting unit Panel/Communication	Adjustment range	Default setting	User setting	Reference
F 7 0 0	0700	Prohibition of parameter change	-	-	0: Permitted 1: Prohibited	0		6.20.1
F 7 0 1	0701	Current/voltage display mode	-	-	0: % 1: A (ampere)/V (volt)	0		6.20.2
F 7 0 2	0702	Frequency free unit magnification	Times	0.01/0.01	0.00: Free unit display disabled (display of frequency) 0.01-200.0	0.00		6.20.3
F 7 0 3	0703	Frequency free unit conversion selection	-	1/1	0: All frequencies display free unit conversion 1: PID frequencies free unit conversion and $F_c$ range change(0.0~FH)	0		
F 7 0 5	0705	Inclination characteristic of free unit display	-	-	0: Negative inclination (downward slope) 1: Positive inclination (upward slope)	1		
F 7 0 6	0706	Bias of free unit display	Hz	0.01/0.01	0.00-FH	0.00		
F 7 0 7	0707	Free step 1 (pressing a panel key once)	Hz	0.01/0.01	0.00: Disabled 0.01-FH	0.00		6.20.4
F 7 0 8	0708	Free step 2 (panel display)	-	1/1	0: Disabled 1-255	0		
F 7 1 0	0710	Standard monitor display selection	-	-	0: Operation frequency (Hz/free unit/step) 1: Frequency command (Hz/free unit/step) 2: Output current (%A) 3: Inverter rated current (A) 4: Inverter load factor (%) 5: Output power (kW) 6: Frequency command after PID control (Hz/free unit/step) 7: Optional item specified from an external control unit 8: Output speed 9: Communication counter 10: Normal state communication counter	0		6.20.5
F 7 2 1	0721	Selection of operation panel stop pattern	-	-	0: Slowdown stop 1: Coast stop	0		6.20.6
F 7 3 0	0730	Prohibition of frequency setting on the operation panel ( $F_c$ )	-	-	0: Permitted 1: Prohibited	0		6.20.1
F 7 3 2	0732	Prohibition of panel local/remote operation (LOC/REM key)	-	-	0: Permitted 1: Prohibited 2: Permitted (Cancelled with the power off)	0		

Title	Communication No.	Function	Unit	Minimum setting unit Panel/Communication	Adjustment range	Default setting	User setting	Reference
F 733	0733	Prohibition of panel operation (RUN/STOP keys)	-	-	0: Permitted 1: Prohibited	0		
F 734	0734	Prohibition of panel emergency stop operation	-	-	0: Permitted 1: Prohibited	0		6.20.1
F 735	0735	Prohibition of panel reset operation	-	-	0: Permitted 1: Prohibited	0		
F 738	0738	Head of parameter display selection	-	-	0: AUF 1: AUH	0		6.20.7
F 748	0748	Integral output power retention selection	-	-	0: Disabled 1: Enabled	1		6.20.8
F 749	0749	Display unit selection for integral output power	-	-	0: 1=1kWh 1: 0.1=1kWh 2: 0.01=1kWh 3: 0.001=1kWh	*1		

\*1 : Default values vary depending on the capacity. ⇒ See the table of page K-14.

### • Communication parameters

Title	Communication No.	Function	Unit	Minimum setting unit Panel/Communication	Adjustment range	Default setting	User setting	Reference
F 800	0800	Communication rate	-	-	0: 9600bps 1: 19200bps	1		6.21
F 801	0801	Parity	-	-	0: NON (No parity) 1: EVEN (Even parity) 2: ODD (Odd parity)	1		
F 802	0802	Inverter number	-	1/1	0-247	0		
F 803	0803	Communication error trip time	s	1/1	0: Disabled 1-100	0		
F 805	0805	Communication waiting time	s	0.01/0.01	0.00: Regular communication 0.01-2.00	0.00		
F 806	0806	Setting of master and slave for communication between inverters	-	-	0: Slave (0 Hz command issued in case the master inverter fails) 1: Slave (Operation continued in case the master inverter fails) 2: Slave (Emergency stop tripping in case the master inverter fails) 3: Master (transmission of frequency commands) 4: Master (transmission of output frequency signals)	0		
F 811	0811	Communication command point 1 setting	%	1/1	0-100	0		6.5.2 6.21
F 812	0812	Communication command point 1 frequency	Hz	0.1/0.01	0.0-200.0	0.0		
F 813	0813	Communication command point 2 setting	%	1/1	0-100	100		
F 814	0814	Communication command point 2 frequency	Hz	0.1/0.01	0.0-200.0	50.0 (WP) 60.0 (WN)		

Title	Communication No.	Function	Unit	Minimum setting unit Panel/Communication	Adjustment range	Default setting	User setting	Reference
F829	0829	Selection of communication protocol	-	-	0: Toshiba inverter protocol 1: ModbusRTU protocol 2: Metasys N2 protocol 3: APOGEE FLN protocol 4: BAC-net protocol	0		6.21
F851	0851	Operation at communication error by disconnection	-	-	0: Inverter stop, communication command, frequency mode open (by $CnCd$ , $Fnd$ ) 1: None (continued operation) 2: Deceleration stop 3: Coast stop 4: Communication error ( $Err5$ trip) or Network error ( $ErrB$ trip)	4		6.21
F856	0856	Number of motor poles for communication	-	-	1: 2 poles 2: 4 poles 3: 6 poles 4: 8 poles 5: 10 poles 6: 12 poles 7: 14 poles 8: 16 poles	2		
F870	0870	Block write data 1	-	-	0: No selection 1: Command 1	0		
F871	0871	Block write data 2	-	-	2: Command 2 3: Frequency command 4: Output data on the terminal board 5: Analog output for communications 6: Motor speed command	0		
F875	0875	Block read data 1	-	-	0: No selection 1: Status information	0		
F876	0876	Block read data 2	-	-	2: Output frequency 3: Output current	0		
F877	0877	Block read data 3	-	-	4: Output voltage 5: Alarm information	0		
F878	0878	Block read data 4	-	-	6: PID feedback value 7: Input terminal board monitor	0		
F879	0879	Block read data 5	-	-	8: Output terminal board monitor 9: VIA terminal board monitor 10: VIB terminal board monitor 11: Output motor speed monitor	0		
F880	0880	Free notes	-	1/1	0-65535	0		
F890	0890	Parameter for option 1	-	1/1	0-65535 *1	0		6.22
F891	0891	Parameter for option 2	-	1/1	0-65535 *1	0		
F892	0892	Parameter for option 3	-	1/1	0-65535 *1	0		
F893	0893	Parameter for option 4	-	1/1	0-65535 *1	0		
F894	0894	Parameter for option 5	-	1/1	0-65535 *1	0		
F895	0895	Parameter for option 6	-	1/1	0-65535 *1	0		
F896	0896	Parameter for option 7	-	1/1	0-65535 *1	0		
F897	0897	Parameter for option 8	-	1/1	0-65535	0		
F898	0898	Parameter for option 9	-	1/1	0-65535	0		
F899	0899	Parameter for option 10	-	1/1	0-65535	0		

\*1: This default value is changed by setting value of F829.

- PM motor parameters

Title	Communication No.	Function	Unit	Minimum setting unit Panel/Communication	Adjustment range	Default setting	User setting	Reference
F9 i0	0910	Step-out detection current level	(A)	1/1	10-150	100		6.23
F9 i1	0911	Step-out detection time	s	0.1/0.1	0.0: No detection 0.1-25.0	0.0		
F9 i2	0912	High-speed torque adjustment coefficient	-	0.01/0.01	0.00-650.0	0.00		

- Default settings by inverter rating

Inverter type	Acceleration Deceleration time	Torque boost value 1/2	PWM carrier frequency	Automatic torque boost value	Motor rated current	Motor no-load current	Motor rated speed		Motor adjustment coefficient	Display unit selection for integral output power
	ACC. DEC. F500, F501	wb/f 172 (%)	F300 (kHz)	F402 (%)	F415 (A)	F416 (%)	F417 (min-1)		F494	F749
							WN/E 9P:2	WP/E 9P:1		
VFFS1-2004PM	10	6.0	12.0	6.2	2.0	65	1680	1400	90	0
VFFS1-2007PM	10	6.0	12.0	5.8	3.4	60	1690	1408	80	0
VFFS1-2015PM	10	6.0	12.0	4.3	6.2	55	1690	1408	70	0
VFFS1-2022PM	10	5.0	12.0	4.1	8.9	52	1680	1400	70	0
VFFS1-2037PM	10	5.0	12.0	3.4	14.8	48	1690	1408	70	1
VFFS1-2055PM	10	4.0	12.0	3.0	21.0	46	1730	1441	70	1
VFFS1-2075PM	10	3.0	12.0	2.5	28.2	43	1730	1441	70	1
VFFS1-2110PM	10	2.0	12.0	2.3	40.6	41	1730	1441	60	1
VFFS1-2150PM	10	2.0	12.0	2.0	54.6	38	1730	1441	50	1
VFFS1-2185PM	30	2.0	8.0	2.0	68.0	36	1750	1458	50	1
VFFS1-2220PM	30	2.0	8.0	1.8	80.0	34	1750	1458	50	1
VFFS1-2300PM	30	2.0	8.0	1.8	108.0	32	1745	1454	50	1
VFFS1-4004PL	10	6.0	12.0	6.2	1.0	65	1680	1400	90	0
VFFS1-4007PL	10	6.0	12.0	5.8	1.7	60	1690	1408	80	0
VFFS1-4015PL	10	6.0	12.0	4.3	3.1	55	1690	1408	70	0
VFFS1-4022PL	10	5.0	12.0	4.1	4.5	52	1680	1400	70	0
VFFS1-4037PL	10	5.0	12.0	3.4	7.4	48	1690	1408	70	1
VFFS1-4055PL	10	4.0	12.0	2.6	10.5	46	1730	1441	70	1
VFFS1-4075PL	10	3.0	12.0	2.3	14.1	43	1730	1441	70	1
VFFS1-4110PL	10	2.0	12.0	2.2	20.3	41	1730	1441	60	1
VFFS1-4150PL	10	2.0	12.0	1.9	27.3	38	1730	1441	50	1
VFFS1-4185PL	30	2.0	8.0	1.9	34.0	36	1750	1458	50	1
VFFS1-4220PL	30	2.0	8.0	1.8	40.0	34	1750	1458	50	1
VFFS1-4300PL	30	2.0	8.0	1.8	54.0	32	1745	1454	50	1
VFFS1-4370PL	30	2.0	8.0	1.8	67.0	27	1750	1458	50	2
VFFS1-4450PL	30	2.0	8.0	1.7	80.0	26	1750	1458	50	2
VFFS1-4550PL	30	2.0	8.0	1.6	98.0	24	1755	1462	40	2
VFFS1-4750PL	30	2.0	8.0	1.5	129.0	28	1775	1479	40	2

■ Table of input terminal functions 1

Function No.	Code	Function	Action
0	-	No function is assigned	Disabled
1	ST	Standby terminal	ON: Ready for operation OFF: Coast stop (gate off)
2	F	Forward run command	ON: Forward run OFF: Slowdown stop
3	R	Reverse run command	ON: Reverse run OFF: Slowdown stop
5	AD2	Acceleration/deceleration 2 pattern selection	ON: Acceleration/deceleration 2 OFF: Acceleration/deceleration 1 or 3
6	SS1	Preset-speed command 1	Selection of 7-speed with SS1 to SS3 (3bits)
7	SS2	Preset-speed command 2	
8	SS3	Preset-speed command 3	
10	RES	Reset command	ON: Acceptance of reset command ON → OFF: Trip reset
11	EXT	Trip stop command from external input device	ON: $\bar{E}$ Trip stop
13	DB	DC braking command	ON: DC braking
14	PID	PID control prohibited	ON: PID control prohibited OFF: PID control permitted
15	PWENE	Permission of parameter editing	ON: Parameter editing permitted OFF: Parameter editing prohibited (If $F170 = 1$ )
16	ST+RES	Combination of standby and reset commands	ON: Simultaneous input from ST and RES
20	F+AD2	Combination of forward run and acceleration/deceleration 2	ON: Simultaneous input from F and AD2
21	R+AD2	Combination of reverse run and acceleration/deceleration 2	ON: Simultaneous input from R and AD2
22	F+SS1	Combination of forward run and preset-speed command 1	ON: Simultaneous input from F and SS1
23	R+SS1	Combination of reverse run and preset-speed command 1	ON: Simultaneous input from R and SS1
24	F+SS2	Combination of forward run and preset-speed command 2	ON: Simultaneous input from F and SS2
25	R+SS2	Combination of reverse run and preset-speed command 2	ON: Simultaneous input from R and SS2
26	F+SS3	Combination of forward run and preset-speed command 3	ON: Simultaneous input from F and SS3
27	R+SS3	Combination of reverse run and preset-speed command 3	ON: Simultaneous input from R and SS3
30	F+SS1+AD2	Combination of forward run, preset-speed command 1 and acceleration/deceleration 2	ON: Simultaneous input from F, SS1 and AD2
31	R+SS1+AD2	Combination of reverse run, preset-speed command 1 and acceleration/deceleration 2	ON: Simultaneous input from R, SS1 and AD2
32	F+SS2+AD2	Combination of forward run, preset-speed command 2 and acceleration/deceleration 2	ON: Simultaneous input from F, SS2 and AD2
33	R+SS2+AD2	Combination of reverse run, preset-speed command 2 and acceleration/deceleration 2	ON: Simultaneous input from R, SS2 and AD2
34	F+SS3+AD2	Combination of forward run, preset-speed command 3 and acceleration/deceleration 2	ON: Simultaneous input from F, SS3 and AD2
35	R+SS3+AD2	Combination of reverse run, preset-speed command 3 and acceleration/deceleration 2	ON: Simultaneous input from R, SS3 and AD2
38	FCHG	Frequency command forced switching	ON: $F200 \neq 0$ (if $F200 = 0$ ) OFF: $F00d$
39	VF2	No.2 Switching of V/F setting	ON: No.2 V/F setting ( $Pt=0, F170, F171, F172, F173$ ) OFF: No.1 V/F setting (Set value of $Pt, vL, vLw, ub, tHr$ )
40	MOT2	No.2 motor switching (VF2+AD2+OCS2)	ON: No.2 motor ( $Pt=0, F170, F171, F172, F173, F185, F500, F501, F503$ ) OFF: No.1 motor (Set value of $Pt, vL, vLw, ub, tHr, RCr, dEc, F502, F504$ )
41	UP	Frequency UP signal input from external contacts	ON: Increase in frequency
42	DOWN	Frequency DOWN signal input from external contacts	ON: Reduction in frequency

■ Table of input terminal functions 2

Function No.	Code	Function	Action
43	CLR	Frequency UP/DOWN cancellation signal input from external contacts	OFF—ON: Resetting of UP/DOWN frequency by means of external contacts
44	CLR+RES	Combination of frequency UP/DOWN cancellation and reset by means of external contacts	ON: Simultaneous input from CLR and RES
45	EXTN	Inversion of trip stop command from external device	OFF: $\bar{E}$ Trip stop
46	OH	Thermal trip stop signal input from external device	ON: $\bar{O}H\bar{Z}$ Trip stop
47	OHN	Inversion of thermal trip stop command from external device	OFF: $\bar{O}H\bar{Z}$ Trip stop
48	SC/LC	Forced switching from remote to local control	Enabled when remote control is exercised ON: Local control (setting of $\bar{C}R\bar{O}d$ , $F\bar{R}\bar{O}d$ and $F\bar{Z}\bar{O}7$ ) OFF: Remote control
49	HD	Operation holding (stop of 3-wire operation)	ON: F (forward run)/R (reverse run) held, 3-wire operation OFF: Slowdown stop
51	CKWH	Display cancellation of the cumulative power amount (kWh)	ON: Monitor display cancellation of the cumulative power amount (kWh)
52	FORCE	Forced operation	ON: Forced operation mode in which operation is not stopped in the event of the occurrence of a soft fault ( $F\bar{Z}\bar{O}4$ Forced fire-speed setting frequency) OFF: Normal operation
53	FIRE	Fire-speed control	ON: Fire-speed operation ( $F\bar{Z}\bar{O}4$ Forced fire-speed setting frequency) OFF: Normal operation
54	STN	Coast stop (gate off)	ON: Coast stop (gate off)
55	RESN	Inversion of RES	ON: Acceptance of reset command OFF → ON: Trip reset
56	F+ST	Combination of forward run and standby	ON: Simultaneous input from F and ST
57	R+ST	Combination of reverse run and standby	ON: Simultaneous input from R and ST
61	OCS2	Forced switching of stall prevention level 2	ON: Enabled at the value of $F\bar{I}\bar{B}5$ OFF: Enabled at the value of $F\bar{E}\bar{G}1$
62	HDRY	Holding of RY-RC terminal output	ON: Once turned on, RY-RC are held on. OFF: The status of RY-RC changes in real time according to conditions.
64	PRUN	Cancellation (clearing) of operation command from panel	0: Operation command canceled (cleared) 1: Operation command retained
65	ICLR	PID control integral value clear	ON: PID control integral value always zero OFF: PID control permitted
66	ST+F+SS1	Combination of standby, forward run and pre-set-speed command 1	ON: Simultaneous input from ST, F and SS1
67	ST+R+SS1	Combination of standby, reverse run and pre-set-speed command 1	ON: Simultaneous input from ST, R and SS1
68	ST+F+SS2	Combination of standby, forward run and pre-set-speed command 2	ON: Simultaneous input from ST, F and SS2
69	ST+R+SS2	Combination of standby, reverse run and pre-set-speed command 2	ON: Simultaneous input from ST, R and SS2
70	ST+F+SS3	Combination of standby, forward run and pre-set-speed command 3	ON: Simultaneous input from ST, F and SS3
71	ST+R+SS3	Combination of standby, reverse run and pre-set-speed command 3	ON: Simultaneous input from ST, R and SS3
72	PIDSW	PID forward/reverse switching	ON: Reversing characteristic by $F\bar{Z}\bar{B}\bar{O}$ selection OFF: Characteristic by $F\bar{Z}\bar{B}\bar{O}$ selection

Note: When function 1, 10, 11, 16, 38, 41-47, 51-55, 62 or 64 is assigned to an input terminal board, the input terminal board is enabled even if the parameter command mode selection  $\bar{C}R\bar{O}d$  is set at 1 (panel).

■ Table of output terminal functions 1

Function No.	Code	Function	Action
0	LL	Frequency lower limit	ON: The output frequency is above the $L L$ set value. OFF: The output frequency is equal to or less than the $L L$ set value.
1	LLN	Inversion of frequency lower limit	Inversion of LL setting
2	UL	Frequency upper limit	ON: Output frequency is equal to or higher than $U L$ value. OFF: Output frequency is lower than $U L$ value.
3	ULN	Inversion of frequency upper limit	Inversion of UL setting
4	LOW	Low-speed detection signal	ON: Output frequency is equal to or higher than $F 100$ value. OFF: Output frequency is lower than $F 100$ value.
5	LOWN	Inversion of low-speed detection signal	Inversion of LOW setting
6	RCH	Designated frequency attainment signal (completion of acceleration/deceleration)	ON: The output frequency is equal to or less than the specified frequency $\pm$ frequency set with $F 102$ . OFF: The output frequency is above the specified frequency $\pm$ frequency set with $F 102$ .
7	RCHN	Inversion of designated frequency attainment signal (inversion of completion of acceleration/deceleration)	Inversion of RCH setting
8	RCHF	Set frequency attainment signal	ON: The output frequency is equal to or less than the frequency set with $F 101 \pm F 102$ . OFF: The output frequency is above the frequency set with $F 101 \pm F 102$ .
9	RCHFN	Inversion of set frequency attainment signal	Inversion of RCHF setting
10	FL	Failure signal (trip output)	ON: When inverter is tripped OFF: When inverter is not tripped
11	FLN	Inversion of failure signal (inversion of trip output)	Inversion of FL setting
12	OT	Over-torque detection	ON: Torque current is equal to or larger than $F 615$ set value and longer than $F 618$ set time. OFF: The torque current is equal to or less than ( $F 615$ set value - $F 619$ set value).
13	OTN	Inversion of over-torque detection	Inversion of OT
14	RUN	Start/Stop	ON: When operation frequency is output or during (d b) OFF: Operation stopped
15	RUNN	Inversion of RUN/STOP	Inversion of RUN setting
16	POL	OL pre-alarm	ON: 50% or more of calculated value of overload protection level OFF: Less than 50% of calculated value of overload protection level
17	POLN	Inversion of OL pre-alarm	Inversion of POL setting
20	POT	Over-torque detection pre-alarm	ON: Torque current is equal to or larger than 70% of $F 615$ set value. OFF: The torque current is below ( $F 615$ set value x 70% - $F 619$ set value).
21	POTN	Inversion of over-torque detection pre-alarm	Inversion of POT setting
22	PAL	Pre-alarm	One of the following is turned on: ON POL, POT, MOFF, UC, OT, LL stop, COT, and instantaneous power failure coast stop. or $\bar{C}$ , $P$ , $H$ issues an alarm All the following are turned off: OFF POL, POT, MOFF, UC, OT, LL stop, COT, and instantaneous power failure coast stop. or $\bar{C}$ , $P$ , $H$ issues no alarm

■ Table of output terminal functions 2

Function No.	Code	Function	Action
23	PALN	Inversion of pre-alarm	Inversion of PAL setting
24	UC	Small-current detection	ON: The output current is equal to or less than $F511$ set value for $F512$ set time. OFF: The output current is equal to or larger than $F511$ set value + 10%.
25	UCN	Inversion of small-current detection	Inversion of UC setting
26	HFL	Significant failure	ON: $ULR, UCL, UL, E, EEP1, EEPn, EPH0, Err2-5, OH2, UP1, EFC, UC, ELP, EHD$ OFF: Failure other than the above
27	HFLN	Inversion of significant failure	Inversion of HFL setting
28	LFL	Insignificant failure	ON: $UL1-3, UP1-3, OH, UL1-2$ OFF: Failure other than the above
29	LFLN	Inversion of insignificant failure	Inversion of LFL setting
30	RDY1	Ready for operation (including ST/RUN)	ON: Ready for operation (ST and RUN are also ON) OFF: Others
31	RDY1N	Inversion of ready for operation (including ST/RUN)	Inversion of RDY1 setting
32	RDY2	Ready for operation (excluding ST/RUN)	ON: Ready for operation (ST and RUN are not ON) OFF: Others
33	RDY2N	Inversion of ready for operation (excluding ST/RUN)	Inversion of RDY2
34	FCVIB	Frequency VIB selection	ON: VIB selected as frequency command OFF: Terminal other than VIB selected as frequency command
35	FCVIBN	Inversion of frequency VIB selection	Inversion of FCVIB
36	FLR	Fault signal (put out also at the time of a retry)	ON: When inverter trips or retries OFF: When inverter does not trip or retry
37	FLRN	Inversion of failure signal (put out also at the time of a retry)	Inversion of FLR
38	OUT0	Specified data output 1	ON: Specified data from remote control FA50: BIT0= 1 OFF: Specified data from remote control FA50: BIT0= 0
39	OUT0N	Inversion of specified data output 1	Inversion of OUT0 setting
42	COT	Cumulative operation time alarm	ON: Cumulative operation time is equal to or longer than $F521$ OFF: Cumulative operation time is shorter than $F521$
43	COTN	Inversion of cumulative operation time alarm	Inversion of COT
44	LTA	Parts replacement alarm	ON: Calculation for parts replacement time is equal to or longer than the preset time ON: Calculation for parts replacement time is shorter than the preset time
45	LTAN	Inversion of replacement alarm	Inversion of LTA
48	LI1	F terminal input signal	ON: The signal input to F terminal is ON OFF: The signal input to F terminal is OFF
49	LI1N	Inversion of F terminal input signal	Inversion of LI1
50	LI2	R terminal input signal	ON: The signal input to R terminal is ON OFF: The signal input to R terminal is OFF
51	LI2N	Inversion of R terminal input signal	Inversion of LI2
52	PIDF	Signal in accordance of frequency command (VIA)	ON: Frequency commanded by $F\beta\beta d$ or $F2\beta\gamma$ and that by VIA show the same value. OFF: Frequency commanded by $F\beta\beta d$ or $F2\beta\gamma$ and that by VIA show different values.



### ■ Table of output terminal functions 3

Function No.	Code	Function	Action
53	PIDFN	Inversion of signal in accordance of frequency command (VIA)	Inversion of PIDF setting
54	MOFF	Undervoltage detection	ON: Undervoltage detected OFF: Other than undervoltage
55	MOFFN	Inversion of undervoltage detection	Inversion of MOFF
56	LOC	Local/remote switching	ON: Local mode OFF: Remote mode
57	LOCN	Inversion of local/remote switching	Inversion of LOC
58	PTC	PTC thermal alarm	ON: 60% and over the protection level by PTC OFF: Normal condition
59	PTCN	Inversion of PTC thermal alarm	Inversion of PTC
60	PIDFB	Signal in accordance of frequency command (VIB)	ON: Frequency commanded by $F \overset{\sim}{n} \overset{\sim}{Q} \overset{\sim}{d}$ or $F \overset{\sim}{2} \overset{\sim}{Q} \overset{\sim}{?}$ and that by VIB show the same value. OFF: Frequency commanded by $F \overset{\sim}{n} \overset{\sim}{Q} \overset{\sim}{d}$ or $F \overset{\sim}{2} \overset{\sim}{Q} \overset{\sim}{?}$ and that by VIB show different values.
61	PIDFBN	Inversion of signal in accordance of frequency command (VIB)	Inversion of PIDFB setting
62	VIAD	Analog VIA detection	ON: The value of VIA is equal to or higher than $F \overset{\sim}{1} \overset{\sim}{B} \overset{\sim}{?} + F \overset{\sim}{1} \overset{\sim}{5} \overset{\sim}{?}$ OFF: The value of VIA is equal to or lower than $F \overset{\sim}{1} \overset{\sim}{B} \overset{\sim}{?} - F \overset{\sim}{1} \overset{\sim}{5} \overset{\sim}{?}$
63	VIADN	Inversion of Analog VIA detection	Inversion of VIAD setting
64	VIBD	Analog VIB detection	ON: The value of VIB is equal to or higher than $F \overset{\sim}{1} \overset{\sim}{B} \overset{\sim}{?} + F \overset{\sim}{1} \overset{\sim}{5} \overset{\sim}{?}$ OFF: The value of VIB is equal to or lower than $F \overset{\sim}{1} \overset{\sim}{B} \overset{\sim}{?} - F \overset{\sim}{1} \overset{\sim}{5} \overset{\sim}{?}$
65	VIBDN	Inversion of Analog VIB detection	Inversion of VIBD setting
66	RCHO	Over set frequency attainment signal	ON: The output frequency is equal to or higher than $F \overset{\sim}{1} \overset{\sim}{Q} \overset{\sim}{1} + F \overset{\sim}{1} \overset{\sim}{Q} \overset{\sim}{2}$ OFF: The output frequency is equal to or lower than $F \overset{\sim}{1} \overset{\sim}{Q} \overset{\sim}{1} - F \overset{\sim}{1} \overset{\sim}{Q} \overset{\sim}{2}$
67	RCHON	Inversion of over set frequency attainment signal	Inversion of RCHO setting
68-253	Disabled	Invalid settings, always OFF (ignored)	Invalid settings, always OFF (ignored)
254	AOFF	Always OFF	Always OFF
255	AON	Always ON	Always ON

# 12. Specifications

## 12.1 Models and their standard specifications

### ■ Standard specifications

Item		Specification											
Input voltage		3-phase 200V											
Applicable motor (kW)		0.4	0.75	1.5	2.2	4.0	5.5	7.5	11	15	18.5	22	30
Rating	Type	VFFS1											
	Form	2004PM	2007PM	2015PM	2022PM	2037PM	2055PM	2075PM	2110PM	2150PM	2185PM	2220PM	2300PM
	Capacity (kVA) Note 1)	1.1	1.8	2.9	4.0	6.7	9.2	12.2	17.6	23.2	28.5	33.5	44.6
	Rated output/current (A) Note 2)	2.8	4.6	7.5	10.6	17.5	24.2	32	46.2	61	74.8 (67.3)	88.0 (79.2)	117.0 (105.3)
	Output voltage Note 3)	3-phase 200V to 240V											
Overload current rating	110%-60 seconds, 180%-2 second												
Power supply	Voltage-frequency	3-phase 200V to 240V - 50/60Hz											
	Allowable fluctuation	Voltage + 10%, -15% Note 4), frequency ±5%											
	Protective method	IP20 Enclosed type										IP00 Open type Note 5)	
Cooling method	Forced air-cooled												
Color	Munsel 5Y-8/0.5												
Built-in filter	Basic filter												

Item		Specification															
Input voltage		3-phase 400V															
Applicable motor (kW)		0.4	0.75	1.5	2.2	4.0	5.5	7.5	11	15	18.5	22	30	37	45	55	75
Rating	Type	VFFS1															
	Form	4004PL	4007PL	4015PL	4022PL	4037PL	4055PL	4075PL	4110PL	4150PL	4185PL	4220PL	4300PL	4370PL	4450PL	4550PL	4750PL
	Capacity (kVA) Note 1)	1.1	1.6	2.8	3.9	6.9	9.1	12.2	17.1	23.2	28.2	33.2	44.6	60.2	71.6	88.4	121.9
	Rated output current (A) Note 2)	1.4	2.2	3.7	5.1	9.1	12.0	16.0	22.5	30.5	37.0 (33.3)	43.5 (38.2)	58.5 (52.7)	79.0 (71.1)	94.0 (84.6)	116.0 (104.4)	160.0 (128.0)
	Rated output voltage Note 3)	3-phase 380V to 480V															
Overload current rating	110%-60 seconds, 180% -2 second																
Power supply	Voltage-frequency	3-phase 380V to 480V - 50/60Hz															
	Allowable fluctuation	Voltage + 10%, -15% Note 4), frequency ±5%															
	Protective method,	IP20 Enclosed type										IP00 Open type Note 5)					
Cooling method	Forced air-cooled																
Color	Munsel 5Y-8/0.5																
Built-in filter	EMI filter																

Note 1: Capacity is calculated at 220V for the 200V models, at 440V for the 400V models.

Note 2: The rated output current in the parenthesis is at 12kHz of PWM carrier frequency ( $F_{300}$ ) setting.

Note 3: Maximum output voltage is the same as the input voltage.

Note 4: ±10% when the inverter is used continuously (load of 100%).

Note 5: Inverter, 22kW or greater, do not have wiring port covers, they have large openings, but there is no space to bend the external cables inside the unit. If they are fitted external to the cabinet, please use an optional wiring port cover.

## ■ Common specification

	Item	Specification
Principal control functions	Control system	Sinusoidal PWM control
	Rated output voltage	Adjustable within the range of 50 to 660V by correcting the supply voltage (not adjustable above the input voltage)
	Output frequency range	0.5 to 200.0Hz, default setting: 0.5 to 80Hz, maximum frequency: 30 to 200Hz
	Minimum setting steps of frequency	0.1Hz: analog input (when the max. frequency is 100Hz), 0.01Hz: Operation panel setting and communication setting.
	Frequency accuracy	Digital setting: within $\pm 0.01\%$ of the max. frequency (-10 to +60°C) Analog setting: within $\pm 0.5\%$ of the max. frequency (25°C $\pm 10^\circ\text{C}$ )
	Voltage/frequency characteristics	V/F constant, variable torque, automatic torque boost, vector control, automatic energy-saving, PM motor control. Auto-tuning. Base frequency (25 - 200Hz) adjusting to 1 or 2, torque boost (0 - 30%) adjusting to 1 or 2, adjusting frequency at start (0.5 - 10Hz)
	Frequency setting signal	External frequency potentiometer (connectable to a potentiometer with a rated impedance of 1 - 10k $\Omega$ ), 0 - 10Vdc (input impedance: VIA/VIB=30k $\Omega$ , 4 - 20mAdc (input impedance: 250 $\Omega$ ).
	Terminal board base frequency	The characteristic can be set arbitrarily by two-point setting. Possible to set individually for three functions: analog input (VIA and VIB) and communication command.
	Frequency jump	Three frequencies can be set. Setting of the jump frequency and the range.
	Upper- and lower-limit frequencies	Upper-limit frequency: 0 to max. frequency, lower-limit frequency: 0 to upper-limit frequency
PWM carrier frequency	Adjustable within a range of 6.0 to 16.0Hz (default: 8 or 12kHz).	
PID control	Setting of proportional gain, integral gain, differential gain and control wait time. Checking whether the amount of processing amount and the amount of feedback agree.	
Operation specifications	Acceleration/deceleration time	Selectable from among acceleration/deceleration times 1 and 2 (0.0 to 3200 sec.). Automatic acceleration/deceleration function. S-pattern acceleration/deceleration 1 and 2 and S-pattern adjustable. Control of forced rapid deceleration and dynamic rapid deceleration
	DC braking	Braking start-up frequency: 0 to maximum frequency, braking rate: 0 to 100%, braking time: 0 to 20 seconds, emergency DC braking
	Input terminal function (programmable)	Possible to select from among 58 functions, such as forward/reverse run signal input, operation base signal input and reset signal input, to assign to 4 input terminals. Logic selectable between sink and source.
	Output terminal functions (programmable)	Possible to select from among 64 functions, such as upper/lower limit frequency signal output, low speed detection signal output, specified speed reach signal output and failure signal output, to assign to FL relay output, RY output terminals.
	Forward/reverse run	The RUN and STOP keys on the operation panel are used to start and stop operation, respectively. The switching between forward run and reverse run can be done from one of the three control units: operation panel, terminal board and external control unit.
	Preset speed operation	Base frequency + 7-speed operation possible by changing the combination of 3 contacts on the terminal board.
	Retry operation	Capable of restarting automatically after a check of the main circuit elements in case the protective function is activated. 10 times (Max.) (selectable with a parameter)
	Various prohibition settings	Possible to write-protect parameters and to prohibit the change of panel frequency settings and the use of operation panel for operation, emergency stop or resetting.
	Auto-restart operation	In the event of a momentary power failure, the inverter reads the rotational speed of the coasting motor and outputs a frequency appropriate to the rotational speed in order to restart the motor smoothly. This function can also be used when switching to commercial power.
Drooping function	The motor is allowed to "slip" according to the load torque current.	
Failure detection signal	1c-contact output: (250Vac-0.5A-cos $\Phi$ =0.4)	

<Continued overleaf>

&lt;Continued&gt;

	Item	Specification
Protective function	Protective function	Stall prevention, current limitation, over-current, output short circuit, over-voltage, over-voltage limitation, undervoltage, ground fault, power supply phase failure, output phase failure, overload protection by electronic thermal function, armature over-current at start-up, load side over-current at start-up, over-torque, undercurrent, overheating, cumulative operation time, life alarm, emergency stop, various pre-alarms
	Electronic thermal characteristic	Switching between standard motor and constant-torque VF motor, switching between motors 1 and 2, setting of overload trip time, adjustment of stall prevention levels 1 and 2, selection of overload stall
	Reset function	Function of resetting by closing contact 1a or by turning off power or the operation panel. This function is also used to save and clear trip records.
Display function	Alarms	Stall prevention, overvoltage, overload, under-voltage, setting error, retry in process, upper/lower limits
	Causes of failures	Over-current, overvoltage, overheating, short-circuit in load, ground fault, overload on inverter, over-current through arm at start-up, over-current through load at start-up, CPU fault, EEPROM fault, RAM fault, ROM fault, communication error. (Selectable: Emergency stop, under-voltage, low voltage, over-torque, motor overload, output open-phase)
	Monitoring function	Operation frequency, operation frequency command, forward/reverse run, output current, voltage in DC section, output voltage, torque, torque current, load factor of inverter, input power, output power, information on input terminals, information on output terminals, version of CPU1, version of CPU2, version of memory, PID feedback amount, frequency command (after PID), integral input power, integral output power, rated current, output speed, communication counter, normal state communication counter, causes of past trips 1 through 4, parts replacement alarm, cumulative operation time
	Past trip monitoring function	Stores data on the past four trips: number of trips that occurred in succession, operation frequency, direction of rotation, load current, input voltage, output voltage, information on input terminals, information on output terminals, and cumulative operation time when each trip occurred.
	Output for frequency meter	Analog output: (1mAdc full-scale DC ammeter or 7.5Vdc full-scale DC ammeter / Rectifier-type AC voltmeter: 1mAdc, 7.5Vdc full-scale), 4 to 20mA/0 to 20mA output
	4-digit 7-segments LED	Frequency: inverter output frequency. Alarm: stall alarm "C", overvoltage alarm "P", overload alarm "L", overheat alarm "H". Status: inverter status (frequency, cause of activation of protective function, input/output voltage, output current, etc.) and parameter settings. Free-unit display: arbitrary unit (e.g. rotating speed) corresponding to output frequency.
	Indicator	Lamps indicating the inverter status by lighting, such as RUN lamp, MON lamp, PRG lamp, % lamp, Hz lamp, LOC/REM key lamp, UP/DOWN key lamp and RUN key lamp. The charge lamp indicates that the main circuit capacitors are electrically charged.
Environments	Use environments	Indoor, altitude: 1000m (Max.), not exposed to direct sunlight, corrosive gas, explosive gas or vibration (less than 5.9m/s <sup>2</sup> ) (10 to 55Hz)
	Ambient temperature	-10 to +60°C Note1) Note2)
	Storage temperature	-20 to +65°C
	Relative humidity	5 to 95% (free from condensation and vapor).

Note 1: Above 40°C: Remove the seal from the top of the inverter and use the inverter with the rated output current reduced.

Note 2: If inverters are installed side by side (with no sufficient space left between them): Remove the seal from the top of each inverter.

When installing the inverter where the ambient temperature will rise above 40°C, remove the seal from the top of the inverter and use the inverter with the rated output current reduced.

## 12.2 Outside dimensions and mass

### ■ Outside dimensions and mass

Voltage class	Applicable motor (kW)	Inverter type	Dimensions (mm)						Drawing	Approx. weight (kg)	
			W	H	D	W1	H1	H2			
3-phase 200V	0.4	VFFS1-2004PM									
	0.75	VFFS1-2007PM									
	1.5	VFFS1-2015PM	107	130	150	93	121.5	13	A	1.2	
	2.2	VFFS1-2022PM									
	4.0	VFFS1-2037PM	142	170	150	126	157	14	B	2.1	
	5.5	VFFS1-2055PM									
	7.5	VFFS1-2075PM	180	220	170	160	210	12	C	4.3	
	11	VFFS1-2110PM									
	15	VFFS1-2150PM	245	310	190	225	295	19.5	D	8.6	
	18.5	VFFS1-2185PM									8.9
22	VFFS1-2220PM	240	420	214	206	403	-	E	16.4		
30	VFFS1-2300PM	320	630	290	280	605	-	G	38.7		
3-phase 400V	0.4	VFFS1-4004PL									
	0.75	VFFS1-4007PL									
	1.5	VFFS1-4015PL	107	130	150	93	121.5	13	A	1.4	
	2.2	VFFS1-4022PL									
	4.0	VFFS1-4037PL									
	5.5	VFFS1-4055PL	142	170	150	126	157	14	B	2.4	
	7.5	VFFS1-4075PL									
	11	VFFS1-4110PL	180	220	170	160	210	12	C	4.7	
	15	VFFS1-4150PL									
	18.5	VFFS1-4185 PL	245	310	190	225	295	19.5	D	9.0	
	22	VFFS1-4220 PL									
	30	VFFS1-4300 PL	240	420	214	206	403	-	E	15.4	
	37	VFFS1-4370 PL									
45	VFFS1-4450 PL	240	550	214	206	529	-	F	23.5		
55	VFFS1-4550 PL										
75	VFFS1-4750 PL	320	630	290	280	605	-	G	39.7		

■ Outline drawing

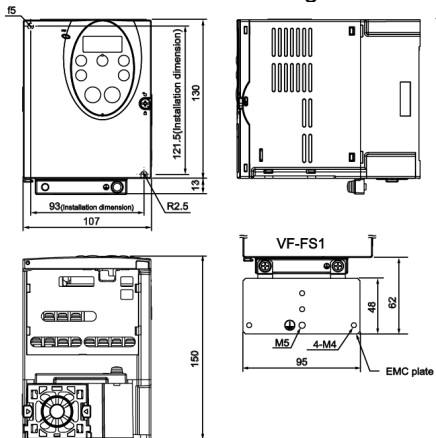

Fig.A

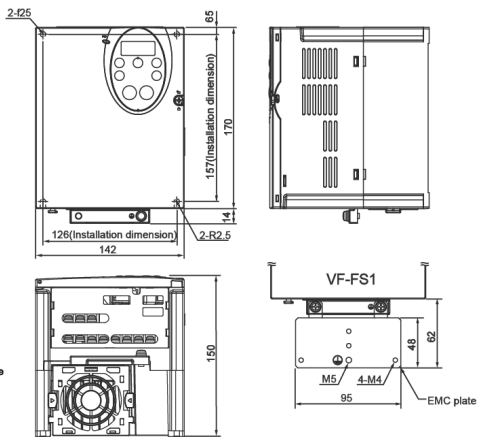

Fig.B

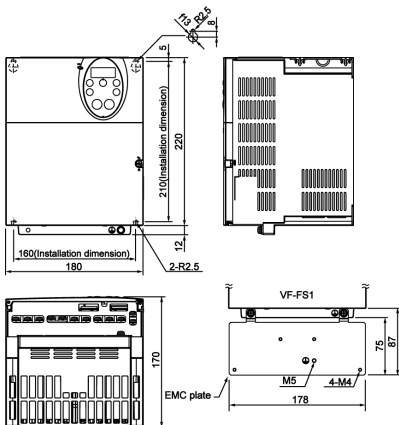

Fig.C

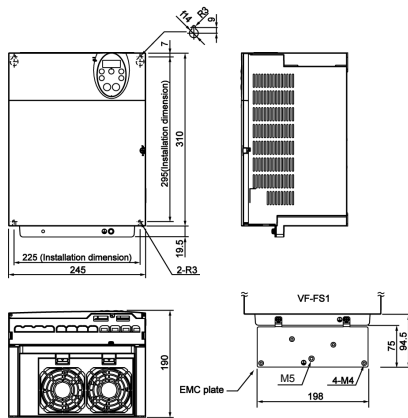
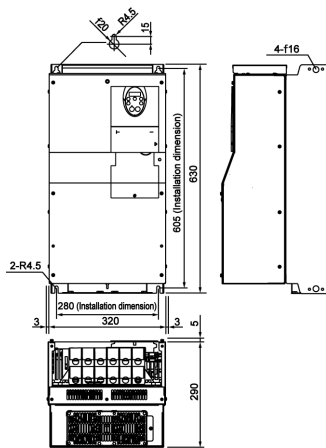
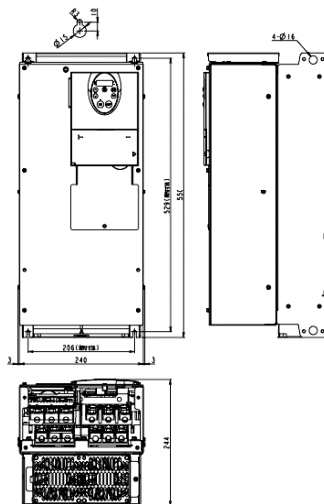
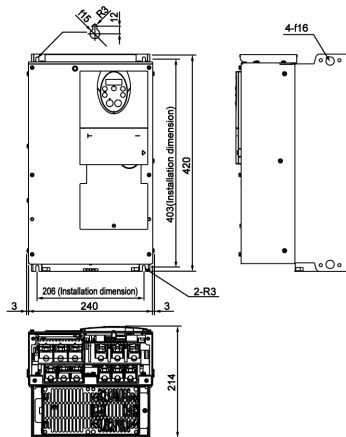

Fig.D



Note 1: To make it easier to grasp the dimensions of each inverter, dimensions common to all inverters in these figures are shown with numeric values but not with symbols.

Here are the meanings of the symbols used.

W: Width

H: Height

D: Depth

W1: Mounting dimension (horizontal)

H1: Mounting dimension (vertical)

H2: Height of EMC plate mounting area

Note 2: Here are the available EMC plate

Fig.A, Fig.B : EMP004Z (Approx. weight : 0.1kg)

Fig.C : EMP005Z (Approx. weight : 0.3kg)

Fig.D : EMP006Z (Approx. weight : 0.3kg)

Note 3: The models shown in Fig. A is fixed at two points: in the upper left and lower right corners.



# 13. Before making a service call

## - Trip information and remedies

### 13.1 Trip causes/warnings and remedies

When a problem arises, diagnose it in accordance with the following table.

If it is found that replacement of parts is required or the problem cannot be solved by any remedy described in the table, contact your Toshiba dealer.

[Trip information]

Error code	Failure code	Problem	Possible causes	Remedies
<i>OL1</i> <i>OL1P</i>	0001 0025	Overcurrent during acceleration Overcurrent flowing in element during acceleration	<ul style="list-style-type: none"> <li>The acceleration time <i>ACC</i> is too short.</li> <li>The V/F setting is improper.</li> <li>A restart signal is input to the rotating motor after a momentary stop, etc.</li> <li>A special motor (e.g. motor with a small impedance) is used.</li> <li>There is possibility of Ground fault trip.</li> </ul>	<ul style="list-style-type: none"> <li>Increase the acceleration time <i>ACC</i>.</li> <li>Check the V/F parameter.</li> <li>Use <i>F301</i> (auto-restart) and <i>F302</i> (coast stop).</li> <li>Adjust the carrier frequency <i>F300</i>.</li> <li>Set the carrier frequency control mode selection parameter <i>F315</i> to 1 or 3 (carrier frequency decreased automatically).</li> </ul>
<i>OL2</i> <i>OL2P</i>	0002 0026	Overcurrent during deceleration Overcurrent flowing in element during deceleration	<ul style="list-style-type: none"> <li>The deceleration time <i>DEC</i> is too short.</li> <li>There is possibility of Ground fault trip.</li> </ul>	<ul style="list-style-type: none"> <li>Increase the deceleration time <i>DEC</i>.</li> <li>Set the carrier frequency control mode selection parameter <i>F315</i> to 1 or 3 (carrier frequency decreased automatically).</li> </ul>
<i>OL3</i> <i>OL3P</i>	0003 0027	Overcurrent during constant speed operation Overcurrent flowing in element during operation	<ul style="list-style-type: none"> <li>The load fluctuates abruptly.</li> <li>The load is in an abnormal condition.</li> <li>There is possibility of Ground fault trip.</li> </ul>	<ul style="list-style-type: none"> <li>Reduce the load fluctuation.</li> <li>Check the load (operated machine).</li> <li>Set the carrier frequency control mode selection parameter <i>F315</i> to 1 or 3 (carrier frequency decreased automatically).</li> </ul>
<i>OL1P</i> <i>OL2P</i> <i>OL3P</i>	0025 0026 0027	Ground fault trip Arm overcurrent at start-up Overheat	<ul style="list-style-type: none"> <li>A current leaked from an output cable or the motor to ground.</li> <li>A main circuit elements is defective.</li> <li>See "OH" trip information in the next page. (for 200V: 11 to 18.5kW, 400V: 15 to 18.5kW models only)</li> </ul>	<ul style="list-style-type: none"> <li>Check cables, connectors, and so on for ground faults.</li> <li>Make a service call.</li> <li>See "OH" trip information in the next page. (for 200V: 11 to 18.5kW, 400V: 15 to 18.5kW models only)</li> </ul>
<i>OLL</i>	0004	Overcurrent (An overcurrent on the load side at start-up)	<ul style="list-style-type: none"> <li>The insulation of the output main circuit or motor is defective.</li> <li>The motor has too small impedance.</li> <li>200V: 11 to 18.5kW, 400V: 15 to 18.5kW model was started, although a current is leaked from an output cable or the motor to ground.</li> </ul>	<ul style="list-style-type: none"> <li>Check the cables and wires for defective insulation.</li> <li>When using 200V: 11 to 18.5kW, 400V: 15 to 18.5kW model, check cables, connectors, and so on for ground faults.</li> </ul>
<i>OLR</i>	0005	Arm overcurrent at start-up	<ul style="list-style-type: none"> <li>A main circuit elements is defective.</li> <li>There is possibility of Ground fault trip.</li> </ul>	<ul style="list-style-type: none"> <li>Make a service call.</li> </ul>
* <i>EPH1</i>	0008	Input phase failure	<ul style="list-style-type: none"> <li>A phase failure occurred in the input line of the main circuit.</li> <li>The input voltage fluctuates abnormally.</li> </ul>	<ul style="list-style-type: none"> <li>Check the main circuit input line for phase failure.</li> <li>Enable <i>F608</i> (input phase failure detection).</li> <li>Check the capacitor in the main circuit for exhaustion.</li> <li>Make a service call.</li> </ul>
* <i>EPHO</i>	0009	Output phase failure	<ul style="list-style-type: none"> <li>A phase failure occurred in the output line of the main circuit.</li> </ul>	<ul style="list-style-type: none"> <li>Check the main circuit output line, motor, etc. for phase failure.</li> <li>Enable <i>F605</i> (Output phase failure detection).</li> </ul>

\* You can select a trip ON/OFF by parameters. (Continued overleaf)

(Continued)

Error code	Failure code	Problem	Possible causes	Remedies
<b>OP1</b>	000A	Overvoltage during acceleration	<ul style="list-style-type: none"> <li>The input voltage fluctuates abnormally.</li> <li>(1) The capacity of power supply is high.</li> <li>(2) A power factor improvement capacitor is opened or closed.</li> <li>(3) A system using a thyristor is connected to the same power distribution line.</li> <li>A restart signal is input to the rotating motor after a momentary stop, etc.</li> <li>There is possibility of output phase failure.</li> </ul>	<ul style="list-style-type: none"> <li>Make a service call.</li> <li>Use <b>F301</b> (auto-restart) and <b>F302</b> (coast stop).</li> <li>Check the main circuit output line, motor, etc. for phase failure.</li> </ul>
<b>OP2</b>	000B	Overvoltage during deceleration	<ul style="list-style-type: none"> <li>The deceleration time <b>dE</b> is too short. (Regenerative energy is too large.)</li> <li><b>F305</b> (overvoltage limit operation) is off.</li> <li>The input voltage fluctuates abnormally.</li> <li>(1) The capacity of power supply is high.</li> <li>(2) A power factor improvement capacitor is opened and closed.</li> <li>(3) A system using a thyristor is connected to the same power distribution line.</li> <li>There is possibility of output phase failure.</li> </ul>	<ul style="list-style-type: none"> <li>Increase the deceleration time <b>dE</b>.</li> <li>Enable <b>F305</b> (overvoltage limit operation).</li> <li>Make a service call.</li> <li>Check the main circuit output line, motor, etc. for phase failure.</li> </ul>
<b>OP3</b>	000C	Overvoltage during constant-speed operation	<ul style="list-style-type: none"> <li>The input voltage fluctuates abnormally.</li> <li>(1) The capacity of power supply is high.</li> <li>(2) A power factor improvement capacitor is opened or closed.</li> <li>(3) A system using a thyristor is connected to the same power distribution line.</li> <li>The motor is in a regenerative state because the load causes the motor to run at a frequency higher than the inverter output frequency.</li> <li>There is possibility of output phase failure.</li> </ul>	<ul style="list-style-type: none"> <li>Make a service call.</li> <li>Check the main circuit output line, motor, etc. for phase failure.</li> </ul>
<b>OL1</b>	000D	Inverter overload	<ul style="list-style-type: none"> <li>The acceleration time <b>ACC</b> is too short.</li> <li>The DC braking amount is too large.</li> <li>The V/F setting is improper.</li> <li>A restart signal is input to the rotating motor after a momentary stop, etc.</li> <li>The load is too large.</li> </ul>	<ul style="list-style-type: none"> <li>Increase the acceleration time <b>ACC</b>.</li> <li>Reduce the DC braking amount <b>F251</b> and the DC braking time <b>F252</b>.</li> <li>Check the V/F parameter setting.</li> <li>Use <b>F301</b> (auto-restart) and <b>F302</b> (coast stop).</li> <li>Use an inverter with a larger rating.</li> </ul>
<b>OL2</b>	000E	Motor overload	<ul style="list-style-type: none"> <li>The V/F setting is improper.</li> <li>The motor is locked up.</li> <li>Low-speed operation is performed continuously.</li> <li>An excessive load is applied to the motor during operation.</li> </ul>	<ul style="list-style-type: none"> <li>Check the V/F parameter setting.</li> <li>Check the load (operated machine).</li> <li>Adjust <b>OL7</b> to the overload that the motor can withstand during operation in a low speed range.</li> </ul>
* <b>OH</b>	0020	Over-torque trip	<ul style="list-style-type: none"> <li>Over-torque reaches to a detection level during operation.</li> </ul>	<ul style="list-style-type: none"> <li>Enable <b>F615</b> (over-torque trip selection).</li> <li>Check system error.</li> </ul>
<b>OH</b>	0010	Overheat	<ul style="list-style-type: none"> <li>The cooling fan does not rotate.</li> <li>The ambient temperature is too high.</li> <li>The vent is blocked up.</li> <li>A heat generating device is installed close to the inverter.</li> <li>The thermistor in the unit is broken.</li> </ul>	<ul style="list-style-type: none"> <li>Restart the operation by resetting the inverter after it has cooled down enough.</li> <li>The fan requires replacement if it does not rotate during operation.</li> <li>Secure sufficient space around the inverter.</li> <li>Do not place any heat generating device near the inverter.</li> <li>Make a service call.</li> </ul>

\* You can select a trip ON/OFF by parameters.  
(Continued overleaf)

(Continued)

Error code	Failure code	Problem	Possible causes	Remedies
<i>OH2</i>	002E	External thermal trip	<ul style="list-style-type: none"> <li>An external thermal trip is input.</li> <li>PTC protection worked.</li> </ul>	<ul style="list-style-type: none"> <li>Check the external thermal input.</li> <li>Check the PTC in the motor.</li> </ul>
<i>E</i>	0011	Emergency stop	<ul style="list-style-type: none"> <li>During automatic operation or remote operation, a stop command is entered from the operation panel or a remote input device.</li> </ul>	<ul style="list-style-type: none"> <li>Reset the inverter.</li> </ul>
<i>EEP1</i>	0012	EEPROM fault 1	<ul style="list-style-type: none"> <li>A data writing error occurs.</li> </ul>	<ul style="list-style-type: none"> <li>Turn off the inverter, then turn it again. If it does not recover from the error, make a service call.</li> </ul>
<i>EEP2</i>	0013	EEPROM fault 2	<ul style="list-style-type: none"> <li>Power supply is cut off during <i>LYP</i> operation and data writing is aborted.</li> </ul>	<ul style="list-style-type: none"> <li>Turn the power off temporarily and turn it back on, and then try <i>LYP</i> operation again.</li> </ul>
<i>EEP3</i>	0014	EEPROM fault 3	<ul style="list-style-type: none"> <li>A data reading error occurred.</li> </ul>	<ul style="list-style-type: none"> <li>Turn off the inverter, then turn it again. If it does not recover from the error, make a service call.</li> </ul>
<i>Err2</i>	0015	Main unit RAM fault	<ul style="list-style-type: none"> <li>The control RAM is defective.</li> </ul>	<ul style="list-style-type: none"> <li>Make a service call.</li> </ul>
<i>Err3</i>	0016	Main unit ROM fault	<ul style="list-style-type: none"> <li>The control ROM is defective.</li> </ul>	<ul style="list-style-type: none"> <li>Make a service call.</li> </ul>
<i>Err4</i>	0017	CPU fault 1	<ul style="list-style-type: none"> <li>The control CPU is defective.</li> </ul>	<ul style="list-style-type: none"> <li>Make a service call.</li> </ul>
* <i>Err5</i>	0018	Communication error	<ul style="list-style-type: none"> <li>An error arises during serial communication.</li> </ul>	<ul style="list-style-type: none"> <li>Check the remote control device, cables, etc.</li> </ul>
<i>Err7</i>	001A	Current detector fault	<ul style="list-style-type: none"> <li>The current detector is defective.</li> </ul>	<ul style="list-style-type: none"> <li>Make a service call.</li> </ul>
<i>Err8</i>	001B	Network error	<ul style="list-style-type: none"> <li>The error was occurred during Network communication.</li> </ul>	<ul style="list-style-type: none"> <li>Check the Network device and wiring.</li> </ul>
* <i>UC</i>	001D	Low-current operation Trip	<ul style="list-style-type: none"> <li>The output current decreased to a low-current detection level during operation.</li> </ul>	<ul style="list-style-type: none"> <li>Enable <i>F510</i> (low-current detection).</li> <li>Check the suitable detection level for the system (<i>F511</i>, <i>F512</i>).</li> <li>Make a service call if the setting is correct.</li> </ul>
* <i>UP1</i>	001E	Undervoltage trip (main circuit)	<ul style="list-style-type: none"> <li>The input voltage (in the main circuit) is too low.</li> </ul>	<ul style="list-style-type: none"> <li>Check the input voltage.</li> <li>Enable <i>F527</i> (undervoltage trip selection).</li> <li>To cope with a momentary stop due to undervoltage, enable <i>F302</i> (coast stop) and <i>F301</i> (auto-restart).</li> </ul>
<i>EF2</i>	0022	Ground fault trip	<ul style="list-style-type: none"> <li>A ground fault occurs in the output cable or the motor.</li> </ul>	<ul style="list-style-type: none"> <li>Check the cable and the motor for ground faults.</li> </ul>
<i>Etn1</i>	0054	Auto-tuning error	<ul style="list-style-type: none"> <li>Check the motor parameter <i>F401</i> to <i>F494</i>.</li> <li>Check the base frequency <i>ub</i> and the base frequency voltage <i>uL</i>.</li> <li>The motor with the capacity of 2 classes or less than the inverter is used.</li> <li>The output cable is too thin.</li> <li>The motor is rotating.</li> <li>The inverter is used for loads other than those of three-phase induction motors.</li> </ul>	
<i>EtYP</i>	0029	Inverter type error	<ul style="list-style-type: none"> <li>Circuit board is changed. (Or main circuit/drive circuit board)</li> </ul>	<ul style="list-style-type: none"> <li>Make a service call.</li> </ul>
* <i>E-18</i>	0032	Brea in analog signal cable	<ul style="list-style-type: none"> <li>The signal input via VIA is below the analog signal detection level set with <i>F633</i>.</li> </ul>	<ul style="list-style-type: none"> <li>Check the cables for breaks. And check the setting of input signal or setting value of <i>F633</i>.</li> </ul>
<i>E-19</i>	0033	CPU communications error	<ul style="list-style-type: none"> <li>A communications error occurs between control CPUs.</li> </ul>	<ul style="list-style-type: none"> <li>Make a service call.</li> </ul>
<i>E-20</i>	0034	Excessive torque boosted	<ul style="list-style-type: none"> <li>The torque boost parameter <i>F402</i> is set too high.</li> <li>The torque boost parameter <i>ub</i> is set too high.</li> <li>The motor has too small impedance.</li> </ul>	<ul style="list-style-type: none"> <li>Re do the Auto-tuning then set <i>F402</i>.</li> <li>Re do the Auto-tuning then set <i>ub</i>.</li> <li>Decrease the setting of the torque boost parameter <i>ub</i>, <i>F402</i>.</li> </ul>
<i>E-21</i>	0035	CPU fault 2	<ul style="list-style-type: none"> <li>The control CPU is defective.</li> </ul>	<ul style="list-style-type: none"> <li>Make a service call.</li> </ul>
<i>SOUE</i>	002F	Step-out (For PM motor only)	<ul style="list-style-type: none"> <li>The motor shaft is locked.</li> <li>One output phase is open.</li> <li>An impact load is applied.</li> </ul>	<ul style="list-style-type: none"> <li>Unlock the motor shaft.</li> <li>Check the interconnect cables between the inverter and the motor.</li> </ul>

\* You can select a trip ON/OFF by parameters.

[Alarm information] Each message in the table is displayed to give a warning but does not cause the inverter to trip.

Error code	Problem	Possible causes	Remedies
<i>OFF</i>	ST terminal OFF	<ul style="list-style-type: none"> <li>The ST-CC circuit is opened.</li> </ul>	<ul style="list-style-type: none"> <li>Close the ST-CC circuit.</li> </ul>
<i>NOFF</i>	Undervoltage in main circuit	<ul style="list-style-type: none"> <li>The supply voltage between R, S and T is under voltage.</li> </ul>	<ul style="list-style-type: none"> <li>Measure the main circuit supply voltage. If the voltage is at a normal level, the inverter requires repairing.</li> </ul>
<i>rt r y</i>	Retry in process	<ul style="list-style-type: none"> <li>The inverter is in the process of retry.</li> <li>A momentary stop occurred.</li> </ul>	<ul style="list-style-type: none"> <li>The inverter is normal if it restarts after several tens of seconds.</li> <li>The inverter restarts automatically. Be careful of the machine because it may suddenly restart.</li> </ul>
<i>Err 1</i>	Frequency point setting error alarm	<ul style="list-style-type: none"> <li>The frequency setting signals at points 1 and 2 are set too close to each other.</li> </ul>	<ul style="list-style-type: none"> <li>Set the frequency setting signals at points 1 and 2 apart from each other.</li> </ul>
<i>CLR</i>	Clear command acceptable	<ul style="list-style-type: none"> <li>This message is displayed when pressing the STOP key while an error code is displayed.</li> </ul>	<ul style="list-style-type: none"> <li>Press the STOP key again to clear the trip.</li> </ul>
<i>EOFF</i>	Emergency stop command acceptable	<ul style="list-style-type: none"> <li>The operation panel is used to stop the operation in automatic control or remote control mode.</li> </ul>	<ul style="list-style-type: none"> <li>Press the STOP key for an emergency stop.</li> <li>To cancel the emergency stop, press any other key.</li> </ul>
<i>H I / L O</i>	Setting error alarm / An error code and data are displayed alternately twice each.	<ul style="list-style-type: none"> <li>An error is found in a setting when data is reading or writing.</li> </ul>	<ul style="list-style-type: none"> <li>Check whether the setting is made correctly.</li> </ul>
<i>HEAd / End</i>	Display of first/last data items	<ul style="list-style-type: none"> <li>The first and last data item in the <i>RUH</i> data group is displayed.</li> </ul>	<ul style="list-style-type: none"> <li>Press MODE key to exit the data group.</li> </ul>
<i>db</i>	DC braking	<ul style="list-style-type: none"> <li>DC braking in process</li> </ul>	<ul style="list-style-type: none"> <li>The message goes off in several tens of seconds if no problem occurs. Note</li> </ul>
<i>dban</i>	Shaft fixing control	<ul style="list-style-type: none"> <li>Motor shaft fixing control is in process.</li> </ul>	<ul style="list-style-type: none"> <li>Normal if the message disappears when a stop command is entered (or the operation command is canceled).</li> </ul>
<i>E 1</i>	Flowing out of excess number of digits	<ul style="list-style-type: none"> <li>The number of digits such as frequencies is more than 4. (The upper digits have a priority.)</li> </ul>	<ul style="list-style-type: none"> <li>Lower the frequency free unit magnification <i>F 7 0 2</i>.</li> </ul>
<i>STOP</i>	Instantaneous power failure coast stop function activated.	<ul style="list-style-type: none"> <li>The coast stop function set with <i>F 3 0 2</i> (Instantaneous power failure coast stop) is activated.</li> </ul>	<ul style="list-style-type: none"> <li>To restart operation, reset the inverter or input an operation signal again.</li> </ul>
<i>LSTOP</i>	Auto-stop because of continuous operation at the lower-limit frequency	<ul style="list-style-type: none"> <li>The automatic stop function selected with <i>F 2 5 6</i> was activated.</li> </ul>	<ul style="list-style-type: none"> <li>To deactivate the automatic stop function, increase the frequency command above the lower-limit frequency (LL) + 0.2 Hz or turn off the operation command.</li> </ul>
<i>in It</i>	Parameters in the process of initialization	<ul style="list-style-type: none"> <li>Parameters are being initialized to default values.</li> </ul>	<ul style="list-style-type: none"> <li>Normal if the message disappears after a while (several seconds to several tens of seconds).</li> </ul>
<i>E - 17</i>	Operation panel key fault	<ul style="list-style-type: none"> <li>The RUN or STOP key is held down for more than 20 seconds.</li> <li>The RUN or STOP key is faulty.</li> </ul>	<ul style="list-style-type: none"> <li>Check the operation panel.</li> </ul>
<i>At n 1</i>	Auto-tuning	<ul style="list-style-type: none"> <li>Auto-tuning in process</li> </ul>	<ul style="list-style-type: none"> <li>Normal if the message disappears after a few seconds.</li> </ul>
<i>ALOS</i>	Break in analog signal cable	<ul style="list-style-type: none"> <li>The signal input via VIA is below the analog signal detection level set with <i>F 6 3 3</i> and setting value of <i>F 6 4 4</i> is one or more.</li> </ul>	<ul style="list-style-type: none"> <li>Check the cables for breaks. And check the setting of input signal or setting value of <i>F 6 3 3</i> and <i>F 6 4 4</i>.</li> </ul>
<i>h999</i>	Integral input power	<ul style="list-style-type: none"> <li>Integral input power is more than 999.99kWh.</li> </ul>	<ul style="list-style-type: none"> <li>Press and hold down the ENT key for 3 seconds or more when power is off or when the input terminal function CKWH is turned on or displayed.</li> </ul>
<i>H999</i>	Integral output power	<ul style="list-style-type: none"> <li>Integral output power is more than 999.99kWh.</li> </ul>	<ul style="list-style-type: none"> <li>Press and hold down the ENT key for 3 seconds or more when power is off or when the input terminal function CKWH is turned on or displayed.</li> </ul>

Note: When the ON/OFF function is selected for DC braking (DB), using the input terminal selection parameter, you can judge the inverter to be normal if "d b" disappears when opening the circuit between the terminal and CC.

[Prealarm display]

$\overline{C}$	Overcurrent alarm	Same as $\overline{O C}$ (overcurrent)
$\overline{P}$	Overvoltage alarm	Same as $\overline{O V}$ (overvoltage)
$\overline{L}$	Overload alarm	Same as $\overline{O L 1}$ and $\overline{O L 2}$ (overload)
$\overline{H}$	Overheat alarm	Same as $\overline{O H}$ (overheat)

If two or more problems arise simultaneously, one of the following alarms appears and blinks.

$\overline{C P}$ ,  $\overline{P L}$ ,  $\overline{C P L}$

The blinking alarms  $\overline{C}$ ,  $\overline{P}$ ,  $\overline{L}$ ,  $\overline{H}$  are displayed in this order from left to right.

## 13.2 Restoring the inverter from a trip

Do not reset the inverter when tripped because of a failure or error before eliminating the cause. Resetting the tripped inverter before eliminating the problem causes it to trip again.

The inverter can be restored from a trip by any of the following operations:

- (1) By turning off the power (Keep the inverter off until the LED turns off.)  
Note:  $\Rightarrow$  See section 6.17.3 (inverter trip retention selection  $F B O P$ ) for details.
- (2) By means of an external signal (Short circuit between RES and CC on terminal board  $\rightarrow$  Open)
- (3) By operation panel operation
- (4) By inputting a trip clear signal from a remote input device  
(Refer to the remote input device operating manual for details.)

To reset the inverter by operation panel operation, follow these steps.

1. Press the  $\text{STOP}$  key and make sure that  $\overline{C L r}$  is displayed.
2. Pressing the  $\text{STOP}$  key again will reset the inverter if the cause of the trip has already been eliminated.

- ★ In case of a trip due to overheating ( $\overline{O H}$ ), the inverter checks the temperature within. Wait until the temperature in the inverter falls sufficiently before resetting the inverter.

[Caution]

Turning the inverter off then turning it on again resets the inverter immediately. You can use this mode of resetting if there is a need to reset the inverter immediately. Note, however, that this operation may damage the system or the motor if it is repeated frequently.

## 13.3 If the motor does not run while no trip message is displayed ...

If the motor does not run while no trip message is displayed, follow these steps to track down the cause.

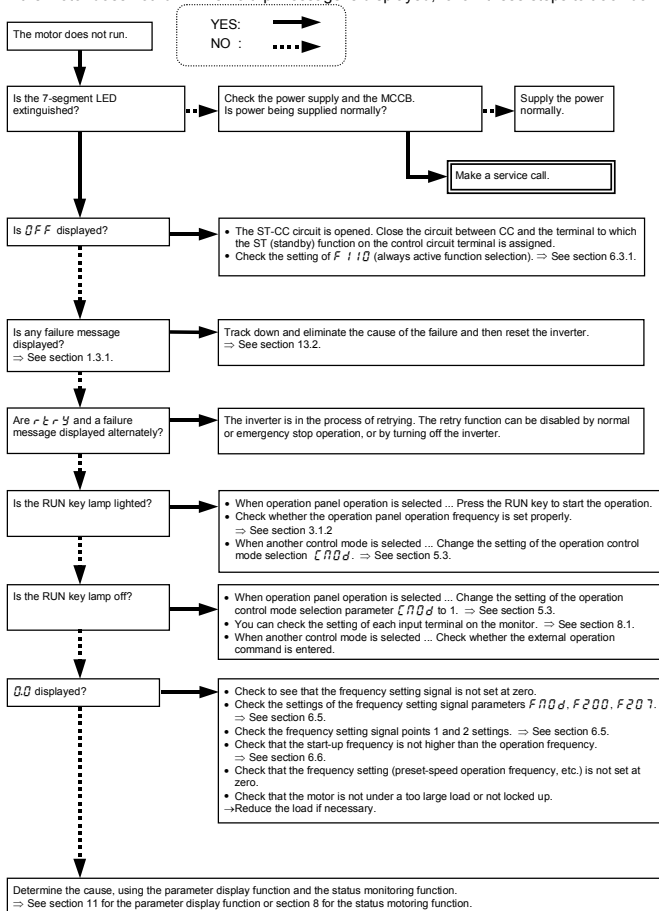

## 13.4 How to determine the causes of other problems



The following table provides a listing of other problems, their possible causes and remedies.

Problems	Causes and remedies
The motor runs in the wrong direction.	<ul style="list-style-type: none"> <li>• Invert the phases of the output terminals U, V and W.</li> <li>• Invert the forward/reverse run-signal terminals of the external input device. ⇒ See section 6.3 "Assignment of functions to control terminals".</li> <li>• Change the setting of the parameter <math>F_r</math> in the case of panel operation.</li> </ul>
The motor runs but its speed does not change normally.	<ul style="list-style-type: none"> <li>• The load is too heavy. Reduce the load.</li> <li>• The soft stall function is activated. Disable the soft stall function. ⇒ See section 5.12.</li> <li>• The maximum frequency <math>F_H</math> and the upper limit frequency <math>U_L</math> are set too low. Increase the maximum frequency <math>F_H</math> and the upper limit frequency <math>U_L</math>.</li> <li>• The frequency setting signal is too low. Check the signal set value, circuit, cables, etc.</li> <li>• Check the setting characteristics (point 1 and point 2 settings) of the frequency setting signal parameters. ⇒ See section 6.5.</li> <li>• If the motor runs at a low speed, check to see that the stall prevention function is activated because the torque boost amount is too large. Adjust the torque boost amount (<math>\alpha b</math>) and the acceleration time (<math>R_L</math>). ⇒ See section 5.11 and 5.1.</li> </ul>
The motor does not accelerate or decelerate smoothly.	<ul style="list-style-type: none"> <li>• The acceleration time (<math>R_L</math>) or the deceleration time (<math>dE</math>) is set too short. Increase the acceleration time (<math>R_L</math>) or the deceleration time (<math>dE</math>).</li> </ul>
A too large current flows into the motor.	<ul style="list-style-type: none"> <li>• The load is too heavy. Reduce the load.</li> <li>• If the motor runs at a low speed, check whether the torque boost amount is too large. ⇒ See section 5.11.</li> </ul>
The motor runs at a higher or lower speed than the specified one.	<ul style="list-style-type: none"> <li>• The motor has an improper voltage rating. Use a motor with a proper voltage rating.</li> <li>• The motor terminal voltage is too low. Check the setting of the base frequency voltage parameter (<math>\alpha L</math>). ⇒ See section 6.12.5. Replace the cable with a cable larger in diameter.</li> <li>• The reduction gear ratio, etc., are not set properly. Adjust the reduction gear ratio, etc.</li> <li>• The output frequency is not set correctly. Check the output frequency range.</li> <li>• Adjust the base frequency. ⇒ See section 5.9.</li> </ul>
The motor speed fluctuates during operation.	<ul style="list-style-type: none"> <li>• The load is too heavy or too light. Reduce the load fluctuation.</li> <li>• The inverter or motor used does not have a rating large enough to drive the load. Use an inverter or motor with a rating large enough.</li> <li>• Check whether the frequency setting signal changes.</li> <li>• If the V/F control selection parameter <math>P_L</math> is set at <math>\bar{3}</math>, check the vector control setting, operation conditions, etc. ⇒ See section 5.10.</li> </ul>
Parameter settings cannot be changed.	<p>Change the setting of the parameter <math>F_{\bar{7}\bar{8}\bar{8}}</math> (prohibition of change of parameter setting) to <math>\bar{0}</math> (permitted) if it is set at <math>\bar{1}</math> (prohibited).</p> <p>* For reasons of safety, some parameters cannot be reprogrammed while the inverter is running. ⇒ See section 4.2.6.</p>

### How to cope with parameter setting-related problems

If you forget parameters which have been reset	<ul style="list-style-type: none"> <li>• You can search for all reset parameters and change their settings. ⇒ See section 4.2.3 for details.</li> </ul>
If you want to return all reset parameters to their respective default settings	<ul style="list-style-type: none"> <li>• You can return all parameters which have been reset to their default settings. ⇒ See section 4.2.7 for details.</li> </ul>

## 14. Inspection and maintenance

 Warning	
 Mandatory	<ul style="list-style-type: none"> <li>• The equipment must be inspected every day. If the equipment is not inspected and maintained, errors and malfunctions may not be discovered which could lead to accidents.</li> <li>• Before inspection, perform the following steps.             <ol style="list-style-type: none"> <li>(1) Shut off all input power to the inverter.</li> <li>(2) Wait at least ten minutes and check to make sure that the charge lamp is no longer lit.</li> <li>(3) Use a tester that can measure DC voltages (800V DC or more), and check that the voltage to the DC main circuits (across PA/+ and PC/-) does not exceed 45V.</li> </ol> </li> </ul> <p style="text-align: center;">Performing an inspection without carrying out these steps first could lead to electric shock.</p>

Be sure to inspect the inverter regularly and periodically to prevent it from breaking down because of the environment of use, such as temperature, humidity, dust and vibration, or deterioration of its components with aging.

### 14.1 Regular inspection

Since electronic parts are susceptible to heat, install the inverter in a cool, well-ventilated and dust-free place. This is essential for increasing the service life.

The purpose of regular inspections is to maintain the correct environment of use and to find any sign of failure or malfunction by comparing current operation data with past operation records.

Subject of inspection	Inspection procedure			Criteria for judgement
	Inspection item	Inspection cycle	Inspection method	
1. Indoor environment	1) Dust, temperature and gas	Occasionally	1) Visual check, check by means of a thermometer, smell check	1) Improve the environment if it is found to be unfavorable. 2) Check for any trace of water condensation. 3) Max. temperature: 60°C
	2) Drop of water or other liquid	Occasionally	2) Visual check	
	3) Room temperature	Occasionally	3) Check by means of a thermometer	
2. Units and components	1) Vibration and noise	Occasionally	Tactile check of the cabinet	Is something unusual is found, open the door and check the transformer, reactors, contactors, relays, cooling fan, etc., inside. If necessary, stop the operation.
3. Operation data (output side)	1) Load current	Occasionally	Moving-iron type AC ammeter	To be within the rated current, voltage and temperature. No significant difference from data collected in a normal state.
	2) Voltage (*)	Occasionally	Rectifier type AC voltmeter	
	3) Temperature	Occasionally	Thermometer	

\*) The voltage measured may slightly vary from voltmeter to voltmeter. When measuring the voltage, always take readings from the same circuit tester or voltmeter.



## ■ Check points

1. Something unusual in the installation environment
2. Something unusual in the cooling system
3. Unusual vibration or noise
4. Overheating or discoloration
5. Unusual odor
6. Unusual motor vibration, noise or overheating
7. Adhesion or accumulation of foreign substances (conductive substances)

## ■ Cautions about cleaning



To clean the inverter, wipe dirt off only its surface with a soft cloth but do not try to remove dirt or stains from any other part. If stubborn stains persist, remove them by wiping gently with a cloth dampened with neutral detergent or ethanol.

Never use any of the chemicals in the table below; the use of any of them may damage or peel the coating away from molded parts (such as plastic covers and units) of the inverter.

Acetone	Ethylene chloride	Tetrachloroethane
Benzen	Ethyl acetate	Trichloroethylene
Chloroform	Glycerin	Xylene

## 14.2 Periodical inspection

Make a periodical inspection at intervals of 3 or 6 months depending on the operating conditions.

 <b>Warning</b>	
 Mandatory	<ul style="list-style-type: none"> <li>• Before inspection, perform the following steps.               <ol style="list-style-type: none"> <li>(1) Shut off all input power to the inverter.</li> <li>(2) Wait at least ten minutes and check to make sure that the charge lamp is no longer lit.</li> <li>(3) Use a tester that can measure DC voltages (800V DC or more), and check that the voltage to the DC main circuits (across PA/+ and PC/-) does not exceed 45V.</li> </ol> </li> </ul> <p><b>Performing an inspection without carrying out these steps first could lead to electric shock.</b></p>
 Prohibited	<ul style="list-style-type: none"> <li>• Never replace any part.</li> </ul> <p>This could be a cause of electric shock, fire and bodily injury. To replace parts, call the local sales agency.</p>

## ■ Check items

1. Check to see if all screwed terminals are tightened firmly. If any screw is found loose, tighten it again with a screwdriver.
2. Check to see if all caulked terminals are fixed properly. Check them visually to see that there is no trace of overheating around any of them.
3. Check all cables and wires for damage. Check them visually.
4. Remove dirt and dust. With a vacuum cleaner, remove dirt and dust. When cleaning, clean the vents and the printed circuit boards. Always keep them clean to prevent an accident due to dirt or dust.

5. If no power is supplied to the inverter for a long time, the performance of its capacity electrolytic capacitor declines.  
When leaving the inverter unused for a long time, supply it with electricity once every two years, for 5 hours or more each, to recover the performance of the capacity electrolytic capacitor. And also check the function of the inverter. It is advisable not to supply the commercial power directly to the inverter but to gradually increase the power supply voltage with a transformer, etc.
6. If the need arises, conduct an insulation test on the main circuit terminal board only, using a 500V insulation tester. Never conduct an insulation test on control terminals other than terminals on the printed circuit board or on control terminals. When testing the motor for insulation performance, separate it from the inverter in advance by disconnecting the cables from the inverter output terminals U, V and W. When conducting an insulation test on peripheral circuits other than the motor circuit, disconnect all cables from the inverter so that no voltage is applied to the inverter during the test.

Note: Before an insulation test, always disconnect all cables from the main circuit terminal board and test the inverter separately from other equipment..

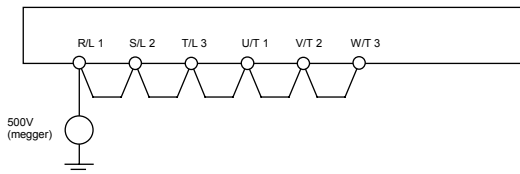

7. Never test the inverter for pressure. A pressure test may cause damage to its components.
8. Voltage and temperature check

Recommended voltmeter : Input side ... Moving-iron type voltmeter (⚡)

Output side ... Rectifier type voltmeter (▶|◀)

It will be very helpful for detecting a defect if you always measure and record the ambient temperature before, during and after the operation.

## ■ Replacement of expendable parts

The inverter is composed of a large number of electronic parts including semiconductor devices. The following parts deteriorate with the passage of time because of their composition or physical properties. The use of aged or deteriorated parts leads to degradation in the performance or a breakdown of the inverter. To avoid such trouble, the inverter should be checked periodically.

Note: Generally, the life of a part depends on the ambient temperature and the conditions of use. The life spans listed below are applicable to parts when used under normal environmental conditions (the ambient temperature : 35 degree, the load factor : 80%, all day running).

## 1) Cooling fan

The fan, which cools down heat-generating parts, has a service life of about 30,000 hours (about 2 or 3 years of continuous operation). The fan also needs to be replaced if it makes a noise or vibrates abnormally.

## 2) Smoothing capacitor

## • Main circuit

The smoothing capacitors applied to this inverter in the main circuit DC section are film type capacitors. Those life time in design value is 15 years, but it is recommended to replace them after it is used for about 10 years under normal conditions. Since the smoothing capacitors are mounted on a printed circuit board, it needs to be replaced together with the circuit board.

## • Control circuit

The smoothing aluminum electrolytic capacitor degrades in performance because of ripple current, etc. The life time in design value is 15 years, but it is recommended to replace them after it is used for about 10 years under normal conditions. Since the smoothing capacitors are mounted on a printed circuit board, it needs to be replaced together with the circuit board.

<Criteria for appearance check>

- Absence of liquid leak
- Absence of case damaged

Note: The operation time is helpful for roughly determining the time of replacement. For the replacement of parts, contact your nearest Toshiba inverter distributor. For safety's sake, never replace any part on your own. (Parts replacement alarms can be known by monitor and alarm output, if it is set.

⇒ See section 6.17.14.

## ■ Standard replacement cycles of principal parts

As guides, the table below lists part replacement cycles that were estimated based on the assumption that the inverter would be used in a normal use environment under normal conditions (ambient temperature, ventilation conditions, and energizing time). The replacement cycle of each part does not mean its service life but the number of years over which its failure rate does not increase significantly.

Part name	Standard replacement cycle	Replacement mode and others
Cooling fan	2 to 3 years	Replacement with a new one
Main circuit smoothing electrolytic capacitor	10 years	Replacement with a new one
Relay and contactor	-	Whether to replace or not depends on the check results
Aluminum electrolytic capacitor mounted on a printed circuit board	10 years	Replace with a new circuit board

Note: The life of a part greatly varies depending on the environment of use.

---

## 14.3 Making a call for servicing

---

For the Toshiba service network, refer to the back cover of this instruction manual. If defective conditions are encountered, please contact the Toshiba service section in charge via your Toshiba dealer.

When making a call for servicing, please inform us of the contents of the rating label on the right panel of the inverter, the presence or absence of optional devices, etc., in addition to the details of the failure.

---

## 14.4 Keeping the inverter in storage

---

Take the following precautions when keeping the inverter in storage temporarily or for a long period of time.

1. Store the inverter in a well-ventilated place away from heat, damp, dust and metal powder.
2. If the printed circuit board in your inverter has an anti-static cover (black cover), do not leave it detached from the circuit board during storage. The cover must be detached before turning on the inverter.
3. If no power is supplied to the inverter for a long time, the performance of its capacity electrolytic capacitor declines.

When leaving the inverter unused for a long time, supply it with electricity once every two years, for 5 hours or more each, to recover the performance of the capacity electrolytic capacitor. And also check the function of the inverter. It is advisable not to supply the commercial power directly to the inverter but to gradually increase the power supply voltage with a transformer, etc.

## 15. Warranty

Any part of the inverter that proves defective will be repaired and adjusted free of charge under the following conditions:

1. This warranty applies only to the inverter main unit.
2. Any part of the inverter which fails or is damaged under normal use within twelve months from the date of delivery shall be repaired free of charge.
3. For the following kinds of failure or damage, the repair cost shall be borne by the customer even within the warranty period.
  - Failure or damage caused by improper or incorrect use or handling, or unauthorized repair or modification of the inverter
  - Failure or damage caused by the inverter falling or an accident during transportation after the purchase
  - Failure or damage caused by fire, salty water or wind, corrosive gas, earthquake, storm or flood, lightning, abnormal voltage supply, or other natural disasters
  - Failure or damage caused by the use of the inverter for any purpose or application other than the intended one
4. All expenses incurred by Toshiba for on-site services shall be charged to the customer, unless a service contract is signed beforehand between the customer and Toshiba, in which case the service contract has priority over this warranty.

## 16. Disposal of the inverter



### Caution



Mandatory

- If you throw away the inverter, have it done by a specialist in industry waste disposal(\*). If you throw away the inverter by yourself, this can result in explosion of capacitor or produce noxious gases, resulting in injury.

(\* ) Persons who specialize in the processing of waste and known as "industrial waste product collectors and transporters" or "industrial waste disposal persons." If the collection, transport and disposal of industrial waste is done by someone who is not licensed for that job, it is a punishable violation of the law. (Laws in regard to cleaning and processing of waste materials)

For safety's sake, do not dispose of the disused inverter yourself but ask an industrial waste disposal agent.

Disposing of the inverter improperly could cause its capacitor to explode and emit toxic gas, causing injury to persons.

---

# TOSHIBA

## TOSHIBA INDUSTRIAL PRODUCTS SALES CORPORATION

International Operations  
9-11, Nihonbashi-honcho 4-chome,  
Chuo-ku, Tokyo 103-0023, Japan  
TEL: +81-(0)3-5644-5509  
FAX: +81-(0)3-5644-5519

## TOSHIBA INTERNATIONAL CORPORATION

13131 West Little York RD., Houston,  
TX 77041, U.S.A  
TEL: +1-713-466-0277  
FAX: +1-713-466-8773

## TOSHIBA ASIA PACIFIC PTE., LTD

152 Beach Rd., #16-00 Gateway East,  
Singapore 189721  
TEL: +65-6297-0990  
FAX: +65-6297-5510

## TOSHIBA CHINA CO., LTD

HSBC Tower, 1000 Lujiazui Ring Road,  
Pudong New Area, Shanghai  
200120, The People's Republic of China  
TEL: +86-(0)21-6841-5666  
FAX: +86-(0)21-6841-1161

## TOSHIBA INTERNATIONAL CORPORATION PTY., LTD

2 Morton Street Parramatta, NSW2150, Australia  
TEL: +61-(0)2-9768-6600  
FAX: +61-(0)2-9890-7542

## TOSHIBA INFORMATION, INDUSTRIAL AND POWER SYSTEMS TAIWAN CORP.

6F, No66, Sec1 Shin Sheng N.RD, Taipei, Taiwan  
TEL: +886-(0)2-2581-3639  
FAX: +886-(0)2-2581-3631



\*E6581381REV02\*

- For further information, please contact your nearest Toshiba Liaison Representative or International Operations - Producer Goods.
- The data given in this manual are subject to change without notice.