

TOSHIBA

TOSHIBA
Leading Innovation >>>



H9 Adjustable Speed Drive



H9 ASD 
Installation and Operation Manual

Document Number: 58682-003

Date: March, 2011

H9 ASD Installation and Operation Manual

Document Number: 58682-003

Date: March, 2011



Introduction

Congratulations on the purchase of the new **H9 Adjustable Speed Drive!**

The **H9 Adjustable Speed Drive (ASD)** is a solid-state AC drive that features Toshiba International Corporation's (TIC) **Vector Control Algorithm** enables the motor to develop high starting torque and provide compensation for motor slip, which results in smooth, quick starts and highly efficient operation. The H9 ASD uses digitally-controlled pulse width modulation. The programmable functions may be accessed via the easy-to-use menu or via the Direct Access Numbers (see [page 76](#)). This feature, combined with TIC's high-performance software, delivers unparalleled motor control and reliability.

The H9 ASD is a very powerful tool, yet surprisingly simple to operate. The user-friendly **Electronic Operator Interface (EOI)** of the H9 ASD has an easy-to-read LCD screen. There is also a read-only LED screen with enhanced visibility that can be read from a greater distance. The EOI provides easy access to the many monitoring and programming features of the H9 ASD.

The motor control software is menu-driven, which allows for easy access to the motor control parameters and quick changes when required.

To maximize the abilities of your new H9 ASD, a working familiarity with this manual will be required. This manual has been prepared for the ASD installer, user, and maintenance personnel. This manual may also be used as a reference guide or for training. With this in mind, use this manual to develop a system familiarity before attempting to install or operate the device.

Important Notice

The instructions contained in this manual are not intended to cover all details or variations in equipment types, nor may it provide contingency concerning the installation, operations, or maintenance of this equipment. Should additional information be required contact your TIC Sales Representative.

The contents of this manual shall not become a part of or modify any prior or existing agreement, commitment, or relationship. The sales contract contains the entire obligation of Toshiba International Corporation. The warranty contained in the contract between the parties is the sole warranty of Toshiba International Corporation and any statements contained herein do not create new warranties or modify the existing warranty.

Any electrical or mechanical modifications to this equipment without prior written consent of Toshiba International Corporation may void all warranties and may void the UL/CSA listing or other safety certifications. Unauthorized modifications may also result in a safety hazard or equipment damage.

Misuse of this equipment could result in injury and equipment damage. In no event will Toshiba International Corporation be responsible or liable for direct, indirect, special, or consequential damage or injury that may result from the misuse of this equipment.

About This Manual

This manual was written by the TIC Technical Publications Group. This group is tasked with providing technical documentation for the **H9 Adjustable Speed Drive**. Every effort has been made to provide accurate and concise information to you, our customer.

At Toshiba International Corporation we are continuously striving for better ways to meet the constantly changing needs of our customers. E-mail your comments, questions, or concerns about this publication to Technical-Publications-Dept@tic.toshiba.com.

Manual's Purpose and Scope

This manual provides information on how to safely install, operate, maintain, and dispose of your **H9 Adjustable Speed Drive**. The information provided in this manual is applicable to the **H9 Adjustable Speed Drive** only.

This manual provides information on the various features and functions of this powerful cost-saving device, including

- Installation,
- System operation,
- Configuration and menu options, and
- Mechanical and electrical specifications.

Included is a section on general safety instructions that describe the warning labels and symbols that are used throughout the manual. Read the manual completely before installing, operating, performing maintenance, or disposing of this equipment.

This manual and the accompanying drawings should be considered a permanent part of the equipment and should be readily available for reference and review. Dimensions shown in the manual are in metric and/or the English equivalent.

Because of our commitment to continuous improvement, Toshiba International Corporation reserves the right, without prior notice, to update information, make product changes, or to discontinue any product or service identified in this publication.

Toshiba International Corporation (TIC) shall not be liable for direct, indirect, special, or consequential damages resulting from the use of the information contained within this manual.

This manual is copyrighted. No part of this manual may be photocopied or reproduced in any form without the prior written consent of Toshiba International Corporation.

© Copyright 2011 Toshiba International Corporation.

TOSHIBA® is a registered trademark of Toshiba Corporation. All other product or trade references appearing in this manual are registered trademarks of their respective owners.

All rights reserved.

Printed in the U.S.A.

Contacting TIC's Customer Support Center

TIC's Customer Support Center can be contacted to obtain help in resolving any **Adjustable Speed Drive** system problem that you may experience or to provide application information.

The Support Center is open from 8 a.m. to 5 p.m. (CST), Monday through Friday. The Center's toll free number is US (800) 231-1412/Fax (713) 937-9349 CAN (800) 872-2192 MEX 01 (800) 527-1204. For after-hours support follow the directions in the outgoing message when calling.

You may also contact Toshiba International Corporation by writing to:

Toshiba International Corporation

13131 West Little York Road

Houston, Texas 77041-9990

Attn: ASD Product Manager.

For further information on TIC's products and services, please visit our website at www.toshiba.com/ind/.

TOSHIBA INTERNATIONAL CORPORATION

H9 Adjustable Speed Drive

Please complete the Warranty Card supplied with the H9 ASD and return it to Toshiba International Corporation by prepaid mail. This will activate the 12 month warranty from the date of installation; but, shall not exceed 18 months from the shipping date.

Complete the following information and retain for your records.

Model Number: _____

Serial Number: _____

Project Number (if applicable): _____

Date of Installation: _____

Inspected By: _____

Name of Application: _____

Table of Contents

General Safety Information	1
Safety Alert Symbol	1
Signal Words	1
Special Symbols	2
Equipment Warning Labels	2
Qualified Personnel	2
Equipment Inspection	3
Handling and Storage	3
Disposal	3
Installation Precautions	4
Location and Ambient Requirements	4
Mounting Requirements	4
Conductor Routing and Grounding	5
Power Connections	6
Protection	6
System Integration Precautions	7
Personnel Protection	7
System Setup Requirements	8
Operational and Maintenance Precautions	9
Motor Characteristics	10
Motor Autotuning	10
Pulse Width Modulation Operation	10
Low-Speed Operation	10
Overload Protection Adjustment	10
Operation Above 60 Hz	10
Power Factor Correction	11
Light Load Conditions	11
Motor/Load Combinations	11
Load-Produced Negative Torque	12
Motor Braking	12
ASD Characteristics	13
Over-Current Protection	13
ASD Capacity	13
Using Vector Control	13
Installation and Connections	14
Installation Notes	14
Mounting the ASD	15

Connecting the ASD	16
Lead Length Specifications	20
I/O and Control	21
Electronic Operator Interface	28
EOI Operation	28
Battery Backup	28
EOI Remote Mounting	29
EOI Features	30
EOI Remote Mounting	33
Command Mode and Frequency Mode Control	36
Command Control (F003)	36
Frequency Control (F004)	37
Override Operation	38
System Configuration and Menu Options	41
Root Menu	41
System Operation	70
Initial Setup	70
Startup Wizard Parameters	70
Operation (Local)	73
Default Setting Changes	74
Save User Settings	75
Direct Access Parameter Information	76
Direct Access Parameters/Numbers	76
Alarms, Trips, and Troubleshooting	244
Alarms and Trips	244
User Notification Codes	245
Alarms	246
Trips/Faults	248
Enclosure and Conduit Plate Dimensions	254
Enclosure Dimensions	254
Conduit Plate Dimensions	259
Current/Voltage Specifications	262
Cable/Terminal/Torque Specifications	264
Dynamic Braking System Specifications	266
Short Circuit Protection Recommendations	268
H9 ASD Optional Devices	269

General Safety Information

DO NOT attempt to install, operate, maintain, or dispose of this equipment until you have read and understood all of the product safety information and directions that are contained in this manual.

Safety Alert Symbol

The **Safety Alert Symbol** is comprised of an equilateral triangle enclosing an exclamation mark. This indicates that a potential personal injury hazard exists.



Signal Words

Listed below are the signal words that are used throughout this manual followed by their descriptions and associated symbols. When the words **DANGER**, **WARNING**, and **CAUTION** are used in this manual they will be followed by important safety information that must be carefully followed.

The word **DANGER** preceded by the safety alert symbol indicates that an imminently hazardous situation exists that, if not avoided or if instructions are not followed precisely, will result in serious injury to personnel or loss of life.



The word **WARNING** preceded by the safety alert symbol indicates that a potentially hazardous situation exists that, if not avoided or if instructions are not followed precisely, could result in serious injury to personnel or loss of life.



The word **CAUTION** preceded by the safety alert symbol indicates that a potentially hazardous situation exists that, if not avoided or if instructions are not followed precisely, may result in minor or moderate injury.



The word **CAUTION** without the safety alert symbol indicates a potentially hazardous situation exists that, if not avoided or if instructions are not followed precisely, may result in equipment and property damage.

CAUTION

Special Symbols

To identify special hazards, other symbols may appear in conjunction with the **DANGER**, **WARNING**, and **CAUTION** signal words. These symbols indicate areas that require special and/or strict adherence to the procedures to prevent serious injury to personnel or loss of life.

Electrical Hazard Symbol

A symbol that is comprised of an equilateral triangle enclosing a lightning bolt indicates a hazard of injury from electrical shock or burn.



Explosion Hazard Symbol

A symbol that is comprised of an equilateral triangle enclosing an explosion indicates a hazard of injury from exploding parts.



Equipment Warning Labels

DO NOT attempt to install, operate, perform maintenance, or dispose of this equipment until you have read and understood all of the product labels and user directions that are contained in this manual.

Warning labels that are attached to the equipment will include the exclamation mark within a triangle. **DO NOT** remove or cover any of these labels. If the labels are damaged or if additional labels are required, contact your TIC Sales Representative.

Labels attached to the equipment are there to provide useful information or to indicate an imminently hazardous situation that may result in serious injury, severe property and equipment damage, or loss of life if safe procedures or methods are not followed as outlined in this manual.

Qualified Personnel

Installation, operation, and maintenance shall be performed by **Qualified Personnel Only**. A Qualified Person is one that has the skills and knowledge relating to the construction, installation, operation, and maintenance of the electrical equipment and has received safety training on the hazards involved (Refer to the latest edition of NFPA 70E for additional safety requirements).

Qualified Personnel shall:

- Have carefully read the entire manual.
- Be familiar with the construction and function of the ASD, the equipment being driven, and the hazards involved.
- Be able to recognize and properly address hazards associated with the application of motor-driven equipment.
- Be trained and authorized to safely energize, de-energize, ground, lock out/tag out circuits and equipment, and clear faults in accordance with established safety practices.
- Be trained in the proper care and use of protective equipment such as safety shoes, rubber gloves, hard hats, safety glasses, face shields, flash clothing, etc., in accordance with established safety practices.

For further information on workplace safety visit www.osha.gov.

Equipment Inspection

- Upon receipt of the equipment inspect the packaging and equipment for shipping damage.
- Carefully unpack the equipment and check for parts that may have been damaged during shipping, missing parts, or concealed damage. If any discrepancies are discovered, it should be noted with the carrier prior to accepting the shipment, if possible. File a claim with the carrier if necessary and immediately notify your TIC Sales Representative.
- **DO NOT** install the ASD if it is damaged or if it is missing any component(s).
- Ensure that the rated capacity and the model number specified on the nameplate conform to the order specifications.
- Modification of this equipment is dangerous and is to be performed by factory trained personnel. When modifications are required contact your TIC Sales Representative.
- Inspections may be required after moving equipment.
- Contact your TIC Sales Representative to report discrepancies or for assistance if required.

Handling and Storage

- Use proper lifting techniques when moving the ASD; including properly sizing up the load, getting assistance, and using a forklift if required.
- Store in a well-ventilated location and preferably in the original carton if the equipment will not be used upon receipt.
- Store in a cool, clean, and dry location. Avoid storage locations with extreme temperatures, rapid temperature changes, high humidity, moisture, dust, corrosive gases, or metal particles.
- The storage temperature range of the H9 ASD is -13° to 149° F (-25° to 65° C).
- Do not store the unit in places that are exposed to outside weather conditions (i.e., wind, rain, snow, etc.).
- Store in an upright position.

Disposal

Never dispose of electrical components via incineration. Contact your state environmental agency for details on disposal of electrical components and packaging in your area.

Installation Precautions

Location and Ambient Requirements

- The TIC ASD is intended for permanent installations only.
- Installation should conform to the **National Electrical Code — Article 110** (*Requirements For Electrical Installations*), all regulations of the **Occupational Safety and Health Administration**, and any other applicable national, regional, or industry codes and standards.

Note: For ALL references to the National Electrical Code (NEC), see the latest release of the National Electrical Code.

- Select a mounting location that is easily accessible, has adequate personnel working space, and adequate illumination for adjustment, inspection, and maintenance of the equipment (refer to NEC Article 110-13).
- **DO NOT** mount the ASD in a location that would produce catastrophic results if it were to fall from its mounting location (equipment damage or injury).
- **DO NOT** mount the ASD in a location that would allow it to be exposed to flammable chemicals or gases, water, solvents, or other fluids.
- Avoid installation in areas where vibration, heat, humidity, dust, fibers, metal particles, explosive/corrosive mists or gases, or sources of electrical noise are present.
- The installation location shall not be exposed to direct sunlight.
- Allow proper clearance spaces for installation. Do not obstruct the ventilation openings. Refer to the section titled [Installation and Connections on pg. 14](#) for further information on ventilation requirements.
- The ambient operating temperature range of the H9 ASD is 14° to 104° F (-10 to 40° C).

Mounting Requirements

- Only **Qualified Personnel** should install this equipment.
- Install the unit in a secure and upright position in a well-ventilated area.
- As a minimum, the installation of the equipment should conform to the **NEC — Article 110**, OSHA, as well as any other applicable national, regional, or industry codes and standards.
- Installation practices should conform to the latest revision of NFPA 70E Electrical Safety Requirements for Employee Workplaces.
- It is the responsibility of the ASD installer/maintenance personnel to ensure that the unit is installed into an enclosure that will protect personnel against electric shock.

Conductor Routing and Grounding



- Use separate metal conduits for routing the input power, output power, and control circuits.
- A separate ground cable should be run inside the conduit with the input power, output power, and control circuits.
- **DO NOT** connect CC to earth ground.
- Use ICC terminal as the return for the V/I input.
- Always ground the unit to prevent electrical shock and to help reduce electrical noise.
- It is the responsibility of the ASD installer/maintenance personnel to provide proper grounding and branch circuit protection in accordance with the NEC and any applicable local codes.

— **The Metal Of Conduit Is Not An Acceptable Ground** —

Grounding Capacitor Switch

The ASD is equipped with noise reduction capacitors which are used to reduce the EMI leakage via the 3-phase power-input circuit and for compliance with the **Electromagnetic Compatibility Directive** (EMC).

The effective value of the capacitor may be increased, reduced, or removed entirely via the **Selector Switch**, **Switching Bar**, or the **Switching Screw** — the type used is typeform-specific.

The **Grounding Capacitor Switch** allows the user to quickly change the value of the capacitance of the 3-phase input circuit without the use of tools.

See the section titled [System Grounding on pg. 18](#) for more on the [Grounding Capacitor](#).

See figures [4](#), [5](#), [6](#), and [7 on pg. 19](#) for an electrical depiction of the leakage-reduction functionality of the [Grounding Capacitor](#) and the methods used to set the capacitance value.

Power Connections



Contact With Energized Wiring Will Cause Severe Injury Or Loss Of Life.

- Turn off, lock out, and tag out all power sources before proceeding to connect the power wiring to the equipment.
- After ensuring that all power sources are turned off and isolated in accordance with established lock out/tag out procedures, connect the 3-phase power source wiring of the correct voltage to the correct input terminals and connect the output terminals to a motor of the correct voltage and type for the application (refer to the NEC Article 300 – Wiring Methods and Article 310 – Conductors For General Wiring). Size the branch circuit conductors in accordance with the NEC Table 310.16.
- Ensure that the 3-phase input power is **NOT** connected to the output of the ASD. This will damage the ASD and may cause injury to personnel.
- **DO NOT** connect resistors across terminals PA – PC or PO – PC. This may cause a fire.
- Ensure the correct phase sequence and the desired direction of motor rotation in the **Bypass** mode (if applicable).

Protection

- Ensure that primary protection exists for the input wiring to the equipment. This protection must be able to interrupt the available fault current from the power line. The equipment may or may not be equipped with an input disconnect (option).
- All cable entry openings must be sealed to reduce the risk of entry by vermin and to allow for maximum cooling efficiency.
- External dynamic braking resistors must be thermally protected.
- It is the responsibility of the ASD installer/maintenance personnel to setup the **Emergency Off** braking system of the ASD. The function of the **Emergency Off** braking function is to remove output power from the drive in the event of an emergency. A supplemental braking system may also be engaged in the event of an emergency. For further information on braking systems, see parameters [F250](#) and [F304](#).

***Note:** A supplemental emergency stopping system should be used with the ASD. Emergency stopping should not be a task of the ASD alone.*

- Follow all warnings and precautions and do not exceed equipment ratings.

System Integration Precautions

The following precautions are provided as general guidelines for the setup of the ASD within the system.

- The TIC ASD is a general-purpose product. It is a system component only and the system design should take this into consideration. Please contact your TIC Sales Representative for application-specific information or for training support.
- The TIC ASD is part of a larger system and the safe operation of the ASD will depend upon observing certain precautions and performing proper system integration.
- Improperly designed or improperly installed system interlocks may render the motor unable to start or stop on command.
- The failure of external or ancillary components may cause intermittent system operation (i.e., the system may start the motor without warning).
- A detailed system analysis and job safety analysis should be performed by the systems designer and/or systems integrator before the installation of the ASD component. Contact your TIC Sales Representative for options availability and for application-specific system integration information if required.

Personnel Protection

- Installation, operation, and maintenance shall be performed by **Qualified Personnel Only**.
- A thorough understanding of the ASD will be required before the installation, operation, or maintenance of the ASD.



- Rotating machinery and live conductors can be hazardous and shall not come into contact with personnel. Personnel should be protected from all rotating machinery and electrical hazards at all times.
- Insulators, machine guards, and electrical safeguards may fail or be defeated by the purposeful or inadvertent actions of workers. Insulators, machine guards, and electrical safeguards are to be inspected (and tested where possible) at installation and periodically after installation for potential hazardous conditions.
- **DO NOT** allow personnel near rotating machinery. Warning signs to this effect shall be posted at or near the machinery.
- **DO NOT** allow personnel near electrical conductors. Contact with electrical conductors can be fatal. Warning signs to this effect shall be posted at or near the hazard.
- Personal protection equipment shall be provided and used to protect employees from any hazards inherent to system operation.

System Setup Requirements

- When using the ASD as an integral part of a larger system, it is the responsibility of the ASD installer/maintenance personnel to ensure that there is a fail-safe in place (i.e., an arrangement designed to switch the system to a safe condition if there is a fault or failure).
- Power factor improvement capacitors or surge absorbers **MUST NOT** be installed on the output of the ASD.
- Use of the built-in system protective features is highly recommended (i.e., E-Off, Overload Protection, etc.).
- The operating controls and system status indicators should be clearly readable and positioned where the operator can see them without obstruction.
- Additional warnings and notifications shall be posted at the equipment installation location as deemed required by [Qualified Personnel](#).

CAUTION

- System safety features should be employed and designed into the integrated system in a manner such that system operation, even in the event of system failure, will not cause harm or result in system damage or injury to personnel (i.e., E-Off, Auto-Restart settings, System Interlocks, etc.).
- The programming setup and system configuration of the ASD may allow it to start the motor unexpectedly. A familiarity with the **Auto-Restart (F301)** settings are a requirement to use this product.
- There may be thermal or physical properties, or ancillary devices integrated into the overall system that may allow for the ASD to start the motor without warning. Signs to this effect must be posted at the equipment installation location.
- If a secondary magnetic contactor (MC) or an ASD output disconnect is used between the ASD and the load, it should be interlocked to halt the ASD before the secondary contact opens. If the output contactor is used for bypass operation, it must be interlocked such that commercial power is never applied to the ASD output terminals (U, V, or W).
- When using an ASD output disconnect, the ASD and the motor must be stopped before the disconnect is either opened or closed. Closing the output disconnect while the 3-phase output of the ASD is active may result in equipment damage or injury to personnel.

Operational and Maintenance Precautions



- Turn off, lock out, and tag out the main power, the control power, and instrumentation connections before inspecting or servicing the drive, opening the door of the enclosure, or connecting/disconnecting the power wiring to the equipment.
- The capacitors of the ASD maintain a residual charge for a period of time after turning the ASD off. The required time for each ASD typeform is indicated with a cabinet label and a **Charge LED** (shown for smaller ASDs in [Figure 2 on pg. 16](#); LED is located on the front panel of larger ASDs). Wait at least the minimum time indicated on the enclosure-mounted label and ensure that the **Charge LED** has gone out before opening the door of the ASD once the ASD power has been turned off.
- Turn the power on only after attaching (or closing) the front cover and **DO NOT** remove or open the front cover of the ASD when the power is on.
- **DO NOT** attempt to disassemble, modify, or repair the ASD. Call your TIC Sales Representative for repair information.
- **DO NOT** place any objects inside of the ASD.
- If the ASD should emit smoke, or an unusual odor or sound, turn the power off immediately.
- The heat sink and other components may become extremely hot to the touch. Allow the unit to cool before coming in contact with these items.
- The **Auto-Restart (F301)** programmable functions of the ASD may allow for the system to start or stop unexpectedly. Signs to this effect are to be clearly posted at the installation location.
- Remove power from the ASD during extended periods of non-use.
- The system should be inspected periodically for damaged or improperly functioning parts, cleanliness, and to ensure that the connectors are tightened securely.

Motor Characteristics

Listed below are some variable speed AC motor control concepts with which the user of the ASD should become familiar.

Motor Autotuning

Motor production methods may cause minor differences in the motor operation. The negative effects of these differences may be minimized by using the **Autotune** feature of the ASD. **Autotuning** is a function of the ASD that measures several parameters of the connected motor and places these readings in a stored table. The software uses the information in the table to help optimize the response of the ASD to application-specific load and operational requirements. The **Autotuning** function may be enabled for automatic tuning, configured manually at [F400](#), or disabled.

The measured parameters include the rotor resistance, the stator resistance, the required excitation inductance, rotational inertia values, and leakage inductance values.

Pulse Width Modulation Operation

The ASD uses sinusoidal **Pulse Width Modulation** (PWM) control. The output current waveform generated by the ASD approaches that of a perfect sine wave; however, the output waveform is slightly distorted. For this reason, the motor may produce more heat, noise, and vibration when operated by an ASD, rather than directly from commercial power.

Low-Speed Operation

Operating a general-purpose motor at lower speeds may cause a decrease in the cooling ability of the motor. Reducing the torque requirement of the motor at lower speeds will decrease the generated heat at lower speeds.

When the motor is to be operated at low speed (less than 50% of full speed) and at the rated torque continuously, a TIC VF motor (designed for use in conjunction with an ASD) is recommended.

Overload Protection Adjustment

The ASD software monitors the output current of the system and determines when an overload condition occurs. The overload current level is a percentage of the rating of the motor. This function protects the motor from overload.

The default setting for the overload detection circuit is set to the maximum rated current of the ASD at the factory. This setting will have to be adjusted to match the rating of the motor with which the ASD is to be used. To change the overload reference level, see [Motor Overload Protection Level 1 on pg. 182](#).

Operation Above 60 Hz

A motor produces more noise and vibration when it is operated at frequencies above 60 Hz. Also, when operating a motor above 60 Hz, the rated limit of the motor or its bearings may be exceeded; this may void the motor warranty.

Contact the motor manufacturer for additional information before operating the motor above 60 Hz.

Power Factor Correction

DO NOT connect a power factor correction capacitor or surge absorber to the output of the ASD.

If the ASD is used with a motor that is equipped with a capacitor for power factor correction, remove the capacitor from the motor.

Connecting either of these devices to the output of the ASD may cause the ASD to malfunction and trip, or the output device may cause an over-current condition resulting in damage to the device or the ASD.

Light Load Conditions

When a motor is operated under a continuous light load (i.e., at a load of less than 50% of its rated capacity) or it drives a load which produces a very small amount of inertia, it may become unstable and produce abnormal vibration or trips because of an over-current condition. In such a case, the carrier frequency may be lowered to compensate for this undesirable condition (see Program ⇒ Special ⇒ Carrier Frequency ⇒ [PWM Carrier Frequency](#)).

Note: When operating in the **Vector Control** mode the carrier frequency should be set to 2.2 kHz or above.

Motor/Load Combinations

When the ASD is used in combination with one of the following motors or loads, it may result in unstable operation.

- A motor with a rated capacity that exceeds the motor capacity recommended for the ASD.
- An explosion-proof motor.

When using the ASD with an explosion-proof motor or other special motor types, lower the carrier frequency to stabilize the operation. **DO NOT** set the carrier frequency below 2.2 kHz if operating the system in the vector control mode.

Note: When operating in the **Vector Control** mode the carrier frequency should be set to 2.2 kHz or above.

If the motor being used is coupled to a load that has a large backlash or if coupled to a reciprocating load, use one of the following procedures to stabilize motor operation.

- Adjust the **S-pattern** acceleration/deceleration setting,
- If operating in the **Vector** control mode, adjust the response time, or
- Switch to the **Constant Torque** control mode.

Load-Produced Negative Torque

When the ASD is used with a load that produces negative torque (an overhauling load), the over-voltage or over-current protective functions of the ASD may cause nuisance tripping.

To minimize the undesirable effects of negative torque the dynamic braking system may be used. The dynamic braking system converts the regenerated energy into heat that is dissipated using a braking resistor. The braking resistor must be suitably matched to the load. Dynamic braking is very effective in reducing the DC bus voltage during a momentary over-voltage condition.

CAUTION

If under extreme conditions the dynamic braking system or a component of this system were to fail, the dynamic braking resistor may experience an extended over-current condition. The DBR circuit was designed to dissipate excessive amounts of heat and if the extended over-current condition were allowed to exceed the circuit parameters, this condition could result in a fire hazard.

To combat this condition, the 3-phase input may be connected using contactors that are configured to open in the event of an extended DBR over-current condition or an internal circuit failure. Using a thermal sensor and/or overload protection as the 3-phase input contactor drive signal, the contactors will open and remove the 3-phase input power in the event of an extended DBR over-current or system over-voltage condition. See [Dynamic Braking System Specifications on pg. 266](#) for more information on using Dynamic Braking with the H9 ASD.

Motor Braking

The motor may continue to rotate and coast to a stop after being shut off due to the inertia of the load. If an immediate stop is required, a braking system should be used. The two most common types of motor braking systems used with the ASD are **DC Injection Braking** and **Dynamic Braking**.

For further information on braking systems, see [DC Injection Braking on pg. 124](#) and [Dynamic Braking on pg. 136](#).

ASD Characteristics

Over-Current Protection

Each ASD model is designed for a specified operating power range. The ASD will incur a trip if the design specifications are exceeded.

However, the ASD may be operated at 100% of the specified output-current range continuously or at 120% for a limited amount of time as indicated in the section titled [Current/Voltage Specifications on pg. 262](#). Also, the [Stall Prevention Level](#) may be adjusted to help with nuisance over-current trips (see [F601](#)).

When using the ASD for an application to control a motor that is rated significantly less than the maximum current rating of the ASD, the over-current limit (Thermal Overload Protection) setting will have to be changed to match the FLA of the motor. For further information on this parameter, see [Motor Overload Protection Level 1 on pg. 182](#).

ASD Capacity

The ASD must not be used with a motor that has a larger capacity than the ASD, even if the motor is operated under a small load. An ASD being used in this way will be susceptible to a high-output peak current which may result in nuisance tripping.

Do not apply a level of input voltage to an ASD that is beyond that which the ASD is rated. The input voltage may be stepped down when required with the use of a step-down transformer or some other type of voltage-reduction system.

Using Vector Control

Using **Vector Control** enables the system to produce very high torque over the entire operating range even at extremely low speeds. **Vector Control** may be used with or without feedback. However, using feedback increases the speed accuracy for applications requiring precise speed control.

See [F015 on pg. 81](#) for further information on using **Vector Control**.

Installation and Connections

The **H9 Adjustable Speed Drive** may be set up initially by performing a few simple configuration settings. To operate properly, the ASD must be securely mounted and connected to a power source (3-phase AC input at the R/L1, S/L2, and T/L3 terminals). The control terminals of the ASD may be used by connecting the terminals of the **Terminal Board** to the proper sensors or signal input sources (see the section titled **I/O and Control** on pg. 21 and **Figure 9** on pg. 24).

System performance may be further enhanced by assigning a function to the output terminals of the **Terminal Board** and connecting the terminals to the proper indicators or actuators (LEDs, relays, contactors, etc.).

Note: The optional ASD interface boards may be used to expand the I/O functionality of the ASD.

Installation Notes

CAUTION

When a brake-equipped motor is connected to the ASD, it is possible that the brake may not release at startup because of insufficient voltage. To avoid this, **DO NOT** connect the brake or the brake contactor to the output of the ASD.

If an output contactor is used for bypass operation, it must be interlocked such that commercial power is never applied to the output terminals of the ASD (U/T1, V/T2, and W/T3).

DO NOT apply commercial power to the ASD output terminals **U/T1, V/T2, and W/T3**.

If a secondary magnetic contactor (MC) is used between the output of the ASD and the motor, it should be interlocked such that the **ST – CC** connection is disconnected before the output contactor is opened.

DO NOT open and then close a secondary magnetic contactor between the ASD and the motor unless the ASD is off and the motor is not rotating.

Note: Re-application of power via a secondary contact while the ASD is on or while the motor is still turning may cause ASD damage.

The ASD input voltage should remain within 10% of the specified input voltage range. Input voltages approaching the upper or lower-limit settings may require that the over-voltage and under-voltage stall protection level parameters be adjusted. Voltages outside of the permissible tolerance should be avoided.

The frequency of the input power should be ± 2 Hz of the specified input frequency.

DO NOT use an ASD with a motor that has a current rating higher than the rated current of the ASD.

The H9 ASD is designed to operate NEMA B motors. Consult with your TIC Sales Representative before using the ASD for special applications such as with an explosion-proof motor or applications with a piston load.

Disconnect the ASD from the motor before megging or applying a bypass voltage to the motor.

Interface problems may occur when an ASD is used in conjunction with some types of process controllers. Signal isolation may be required to prevent controller and/or ASD malfunction (contact your TIC Sales Representative or the process controller manufacturer for additional information about compatibility and signal isolation).

Use caution when setting the output frequency. Over speeding a motor decreases its ability to deliver torque and may result in damage to the motor and/or the driven equipment.

Not all H9 ASDs are equipped with internal primary power input fuses (HP dependent). When connecting two or more drives that have no internal fuse to the same power line as shown in [Figure 1](#), select a circuit-breaking configuration that will ensure that if a short circuit occurs in ASD 1, only MCCB2 trips, not MCCB1. If it is not feasible to use this configuration, insert a fuse between MCCB2 and ASD 1.

Figure 1. Typical Circuit Breaker Configuration.

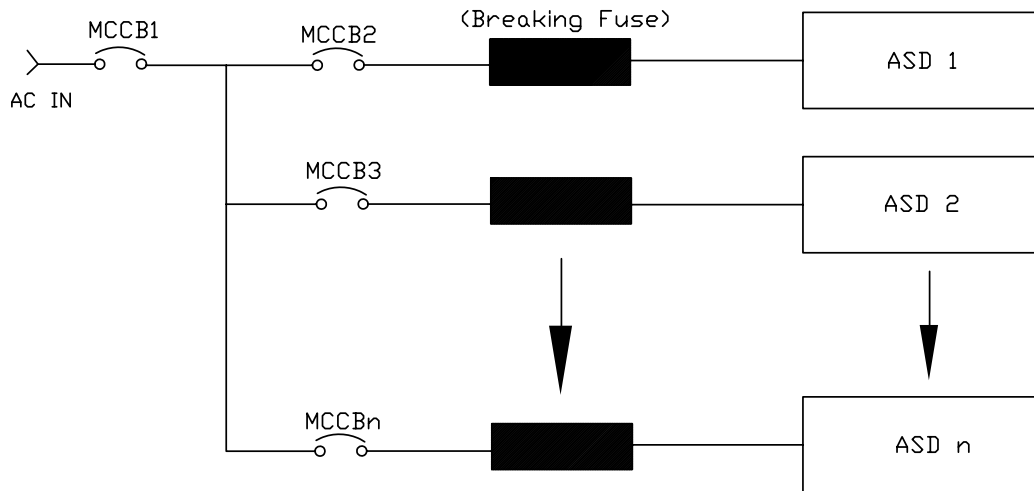

Mounting the ASD

CAUTION

— The following thermal specifications apply to the 230-volt and 460-volt ASDs ONLY —

Install the unit securely in a well ventilated area that is out of direct sunlight.

The process of converting AC to DC, and then back to AC produces heat. During normal ASD operation, up to 5% of the input energy to the ASD may be dissipated as heat. If installing the ASD in a cabinet, ensure that there is adequate ventilation.

DO NOT operate the ASD with the enclosure door open.

The ambient operating temperature rating of the 3.0 to 20 HP H9 ASD is 14° to 104° F (-10° to 40° C).

When installing adjacent ASDs horizontally TIC recommends at least 5 cm of space between adjacent units. However, horizontally mounted ASDs may be installed side-by-side with no space in between the adjacent units — side-by-side installations require that the top cover be removed from each ASD.

For 150 HP and above ASDs, a minimum of 50 cm of space is required above and below adjacent units and any obstruction. This space is the recommended minimum space requirement for the ASD and ensures that adequate ventilation is provided for each unit. More space will provide a better environment for cooling (see the section titled [Enclosure and Conduit Plate Dimensions](#) on [pg. 254](#) for additional information on mounting space requirements).

Note: Ensure that the ventilation openings are not obstructed.

Connecting the ASD



Refer to the section titled [Installation Precautions on pg. 4](#) and the section titled [Lead Length Specifications on pg. 20](#) before attempting to connect the ASD and the motor to electrical power.

Power Connections



Contact With 3-Phase Input/Output Terminals May Cause An Electrical Shock Resulting In Injury Or Loss Of Life.

See the [Typical Connection Diagram on pg. 26](#) for a system I/O connectivity schematic.

An inductor (DCL) may be connected across the **PO** and **PA/+** terminals to provide additional filtering. When not used, a jumper must be connected across these terminals (see [Typical Connection Diagram on pg. 26](#)).

PA/+ and **PB** are used for the DBR connection if using a braking resistor.

PC/- is the negative terminal of the DC bus.

R/L1, **S/L2**, and **T/L3** are the 3-phase input supply terminals for the ASD.

U/T1, **V/T2**, and **W/T3** are the output terminals of the ASD that connect to the motor.

The location of the **Charge LED** for the smaller typeform ASD is provided in [Figure 2](#). The **Charge LED** is located on the front door of the enclosure of the larger ASDs.

Figure 2. Typical H9 ASD Input/output Terminals and the [Grounding Capacitor Switch](#).

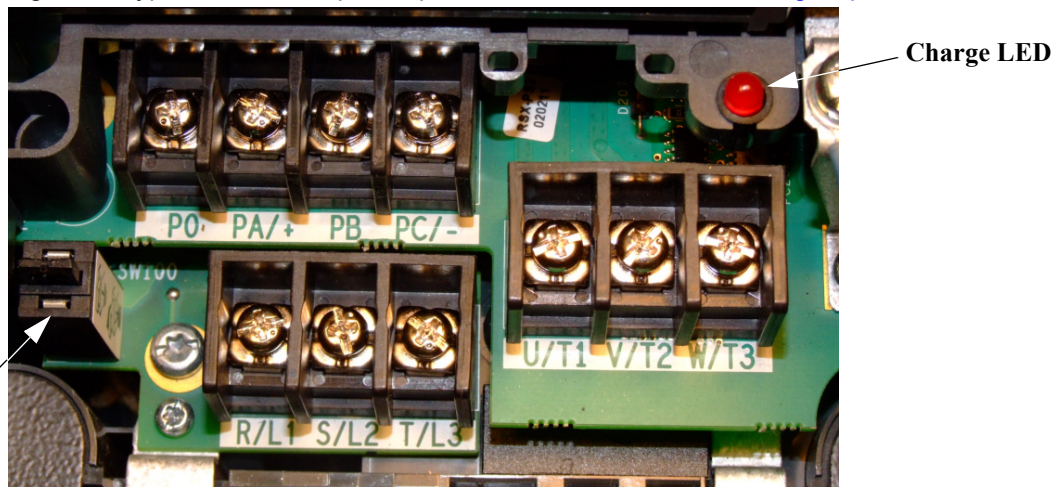

Grounding Capacitor Switch — Pull for **Small** capacitance/push for **Large** capacitance.

Power Connection Requirements

Connect the 3-phase input power to the input terminals of the ASD at **R/L1**, **S/L2**, and **T/L3** (see [Figure 3](#) for the typical electrical connection scheme). Connect the output of the ASD to the motor from the ASD terminals **U/T1**, **V/T2**, and **W/T3**. The input and output conductors and terminal lugs used shall be in accordance with the requirements listed in the section titled [Current/Voltage Specifications](#) on [pg. 262](#).

If multiple conductors are used in parallel for the input or output power and it is necessary to use separate conduits, each parallel set shall have its own conduit and not share its conduit with other parallel sets (i.e., place U1, V1, W1, and a ground wire in one conduit and U2, V2, W2 and a ground wire in another; refer to the NEC Article 300.20 and Article 310.4). National and local electrical codes should be referenced if three or more power conductors are run in the same conduit (refer to the NEC Article 310 adjustment factors).

Note: *National and local codes should be referenced when running more than three conductors in the same conduit.*

Install a molded case circuit breaker (MCCB) or fuse between the 3-phase power source and the ASD in accordance with the fault current setting of the ASD and the **NEC Article 430**.

The ASD is designed and tested to comply with UL Standard 508C. Modifications to the ASD system or failure to comply with the short circuit protection requirements outlined in this manual may disqualify the UL rating. See [Table 22](#) on [pg. 268](#) for typeform-specific short circuit protection recommendations.

As a minimum, the installation of the ASD shall conform to the **NEC Article 110**, the **Occupational Safety and Health Administration** requirements, and to any other local and regional industry codes and standards.

Note: *In the event that the motor rotates in the wrong direction when powered up, reverse any two of the three ASD output power leads (U, V, or W) connected to the motor.*

Figure 3. H9 ASD/Motor Typical Connection Diagram.

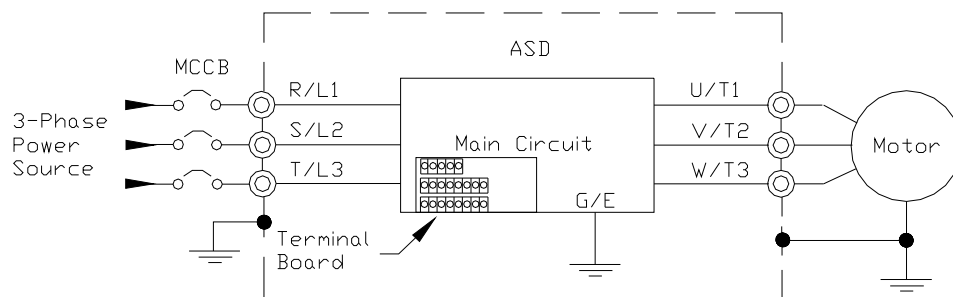

System Grounding

Proper grounding helps to prevent electrical shock and to reduce electrical noise. The ASD is designed to be grounded in accordance with **Article 250** of the NEC or **Section 10/Part One** of the **Canadian Electrical Code (CEC)**.

The grounding conductor shall be sized in accordance with **Article 250-122** of the NEC or **Part One-Table 6** of the CEC.

— The Metal Of Conduit Is Not An Acceptable Ground —

The input, output, and control lines of the system shall be run in separate metal conduits and each shall have its own ground conductor.

ASDs produce high-frequency noise — take steps to avoid the negative effects of noise. Listed below are some examples of measures that will help to combat noise problems.

- **DO NOT** install the input power and output power wires in the same duct or in parallel with each other, and do not bind them together.
- **DO NOT** install the input/output power wires and the wires of the control circuit in the same duct or in parallel with each other, and do not bind them together.
- Use shielded wires or twisted wires for the control circuits.
- Ensure that the grounding terminals (G/E) of the ASD are securely connected to ground.
- Connect a surge suppressor to every electromagnetic contactor and every relay installed near the ASD.
- Install noise filters as required.

Grounding Capacitor

The **Grounding Capacitor** plays a role in minimizing the effects of leakage current through the ASD system and through ground paths to other systems. Leakage current may cause the improper operation of earth-leakage current breakers, leakage-current relays, ground relays, fire alarms, and other sensors — and it may cause superimposed noise on CRT screens.

The **Grounding Capacitor Switch** allows the user to quickly change the value of the leakage-reduction capacitance of the 3-phase input circuit. See figures 4, 5, 6, and 7 on pg. 19 for an electrical depiction of the leakage-reduction functionality and the methods used to change the capacitance value. The method used is typeform-specific.

If using a 460-volt 5 HP ASD or a 460-volt ASD that is in the range of 7.5 HP to 25 HP, and the **U/T1**, **V/T2**, and **W/T3** connections to the motor are 100 meters or more in length, the ASD **Carrier Frequency** must be set to 4 kHz or less when activating or deactivating the **Grounding Capacitor Switch**. ASD overheating may occur if the **Carrier Frequency** is set above 4 kHz when activating or deactivating the **Grounding Capacitor Switch**.

See pg. 5 for more information on the **Grounding Capacitor Switch** and pg. 16 for the location.

Figure 4. The **Grounding Capacitor Switch** is used on typeforms **230-volt** 0.75 HP to 10 HP and the **25** and **30 HP/460-volt** 1.0 HP to 25 HP. The value may be set to **Maximum** (default setting) or to **Zero** by pushing or pulling the switch actuator, respectively.

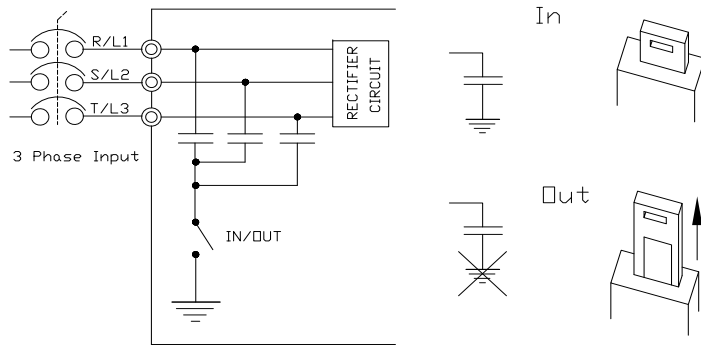

Figure 5. The **Grounding Capacitor Switch** is used on typeforms **230-volt** 15 HP to 20 HP and the **40 HP to 60 HP/460-volt** 30 HP to 100 HP. The value may be set to **Large** (default setting) or **Small** by pushing or pulling the switch actuator, respectively.

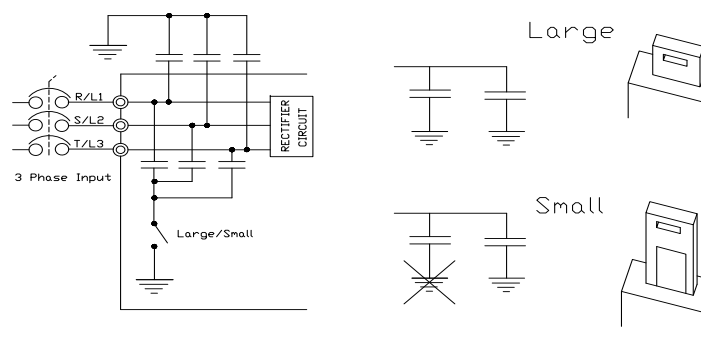

Figure 6. The **Grounding Capacitor Bar** is used on typeforms **230-volt** 75 HP and the **100 HP/460-volt** 125 HP and the **150 HP**. The value may be set to **Large** or **Small** (default setting) by connecting or disconnecting the switching bar, respectively.

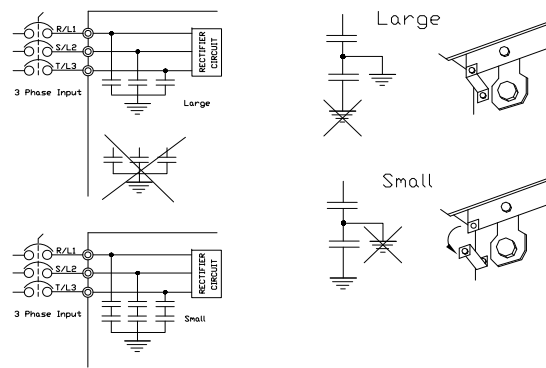
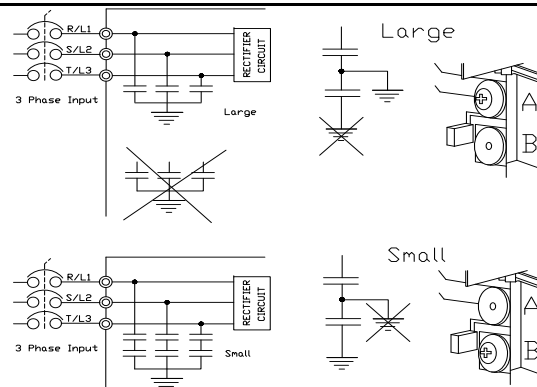

Figure 7. The **Grounding Capacitor Screw** is used on typeforms **460-volt** 200 HP and above. The value may be set to **Large** or **Small** (default setting) by placing the screw in the **A** position or by placing the screw in the **B** position, respectively.



Lead Length Specifications

Adhere to the NEC and any local codes during the installation of ASD/motor systems. Excessive lead lengths may adversely effect the performance of the motor. Special cables are not required. Lead lengths from the ASD to the motor in excess of those listed in [Table 1](#) may require filters to be added to the output of the ASD. [Table 1](#) lists the suggested maximum lead lengths for the listed motor voltages.

Table 1. Lead Length Recommendations.

Model	PWM Carrier Frequency	NEMA MG1 Part 31 Compliant Motors	NEMA MG1 Part 30 Compliant Motors
230-Volt	All	1000 feet	450 feet
460-Volt	< 5 kHz	600 feet	200 feet
	≥ 5 kHz	300 feet	100 feet

Note: *Contact the TIC Customer Support Center for application assistance when using lead lengths in excess of those listed.*

Exceeding the peak voltage rating or the allowable thermal rise time of the motor insulation will reduce the life expectancy of the motor.

*When operating in the **Vector Control** mode the carrier frequency should be set to 2.2 kHz or above.*

I/O and Control

The H9 ASD can be controlled by several input types and combinations thereof, as well as operate within a wide range of output frequency and voltage levels. This section discusses the ASD control methods and supported I/O functions.

The **Terminal Board** supports discrete and analog I/O functions and is shown in [Figure 9 on pg. 24](#).

[Table 2](#) lists the names, functions, and settings (default settings of programmable terminals) of the input and output terminals of the **Terminal Board**.

Note: To use the input lines of the **Terminal Board** to provide **Run** commands the **Command Mode** setting must be set to **Terminal Block**.

[Typical Connection Diagram on pg. 26](#) shows the typical connection diagram for the H9 ASD system.

Table 2. Terminal Board Terminal Names and Functions.

Terminal Name	Input/Output	Function (Default Setting If Programmable) (See Terminal Descriptions on pg. 22)	Circuit Config.
ST	Discrete Input Connect to CC to activate (Sink mode).	Standby — Multifunctional programmable discrete input. Activation required for normal ASD operation.	Figure 10 on pg. 25 .
RES		Reset — Multifunctional programmable discrete input. Resets ASD.	
F		Forward — Multifunctional programmable discrete input.	
R		Reverse — Multifunctional programmable discrete input.	
S1		Preset Speed 1 — Multifunctional programmable discrete input.	
S2		Preset Speed 2 — Multifunctional programmable discrete input.	
S3		Preset Speed 3 — Multifunctional programmable discrete input.	
S4		Preset Speed 4 — Multifunctional programmable discrete input.	
O1A/B (OUT1)	Switched Output	Low Speed — Multifunctional programmable discrete output.	Figure 16 on pg. 25 .
O2A/B (OUT2)		Reach Frequency — Multifunctional programmable discrete output.	
FLA		Fault relay (N.O.).	Figure 19 on pg. 25 .
FLB		Fault relay (N.C.).	
FLC	Fault relay (common).		
RR	Analog Input	Frequency Mode 1 — Multifunction programmable analog input. (0.0 to 10 VDC input — 0 Hz to Maximum Frequency).	Figure 11 on pg. 25 .
RX		Multifunctional programmable analog input (-10 to +10 VDC input).	Figure 12 on pg. 25 .
V/I (Select V or I via SW301)		Unassigned — V — Multifunctional programmable isolated analog voltage input (0 to 10 VDC input)	Figure 13 on pg. 25 .
		Frequency Mode 2 (default SW301 setting) — I — Multifunctional programmable isolated analog current input (4 [0] to 20 mADC input — 0 Hz to Maximum Frequency).	
AM	Analog Output	Output Current — Current output that is proportional to the output current of the ASD or to the magnitude of the function assigned to this terminal (see Table 8 on pg. 239 for assignment listing).	Figure 18 on pg. 25
FM		Output Frequency — Current or Voltage output that is proportional to the output frequency of the ASD or to the magnitude of the function assigned to this terminal (see Table 8 on pg. 239). Select Current or Voltage at F681 .	
SU+	DC Input	Externally-supplied 24 VDC backup control power (1.1 A min.).	
P24	DC Output	24 VDC output (200 mA max.).	Figure 14 on pg. 25 .
PP		10.0 VDC/10 mA voltage source for an external potentiometer.	Figure 15 on pg. 25 .
FP	Pulsed Output	Frequency Pulse — Multifunctional programmable output pulse train of a frequency based on the output frequency of the ASD (see Table 6 on pg. 237).	Figure 17 on pg. 25 .
IICC	—	Return for the V/I input terminal. (see IICC on pg. 105).	DO NOT connect to Earth Gnd or to each other.
CCA	—	Return for the RR, RX, P24, and the PP terminals.	
CC	—	Return for the AM, FM, SU+, and the discrete input terminals.	

Terminal Descriptions

Note: *The programmable terminal assignments may be accessed and changed from the default settings as mapped on [pg. 46](#) or via the **Direct Access** method: Program ⇒ Direct Access ⇒ **Applicable Parameter Number**. See the section titled [Program Mode Menu Navigation on pg. 46](#) for the applicable **Direct Access** parameter numbers. For further information on terminal assignments and default setting changes, see the sections titled [Terminal on pg. 47](#) and [Default Setting Changes on pg. 74](#).*

Note: *See the section titled [Cable/Terminal/Torque Specifications on pg. 264](#) for the ASD conductor and terminal electrical specifications.*

ST — The default setting for this terminal is the **Standby** mode controller. As the default setting, this terminal must be activated for normal system operation. The **ST** terminal is activated by connecting **CC** to this terminal (Sink mode). When deactivated, **OFF** is flashed on the LED screen and the **Not-Ready-to-Run** icon is displayed on the LCD screen as shown in [Figure 22 on pg. 32](#). This input terminal may be programmed to any of the functions listed in [Table 5 on pg. 234](#) (see [F113](#)).

RES — The default setting for this terminal is **Reset**. The **RES** terminal is activated by connecting **CC** to this terminal (Sink mode). A momentary connection to **CC** resets the ASD and any fault indications from the display. **Reset** is effective when faulted only. This input terminal may be programmed to any of the functions listed in [Table 5 on pg. 234](#) (see [F114](#)).

F — The default setting for this terminal is the **Forward** run command. The **F** terminal is activated by connecting **CC** to this terminal (Sink mode). This input terminal may be programmed to any of the functions listed in [Table 5 on pg. 234](#) (see [F111](#)).

R — The default setting for this terminal is the **Reverse** run command. The **R** terminal is activated by connecting **CC** to this terminal (Sink mode). This input terminal may be programmed to any of the functions listed in [Table 5 on pg. 234](#) (see [F112](#)).

S1 — The default setting for this terminal is the **Preset Speed 1** (see [Preset Speed 1 on pg. 83](#)). The **S1** terminal is activated by connecting **CC** to this terminal (Sink mode). This input terminal may be programmed to any of the functions listed in [Table 5 on pg. 234](#) (see [F115](#)).

S2 — The default setting for this terminal is the **Preset Speed 2** (see [Preset Speed 2 on pg. 83](#)). The **S2** terminal is activated by connecting **CC** to this terminal (Sink mode). This input terminal may be programmed to any of the functions listed in [Table 5 on pg. 234](#) (see [F116](#)).

S3 — The default setting for this terminal is the **Preset Speed 3** (see [Preset Speed 3 on pg. 84](#)). The **S3** terminal is activated by connecting **CC** to this terminal (Sink mode). This input terminal may be programmed to any of the functions listed in [Table 5 on pg. 234](#) (see [F117](#)).

S4 — The default setting for this terminal is the **Preset Speed 4** (see [Preset Speed 4 on pg. 84](#)). The **S4** terminal is activated by connecting **CC** to this terminal (Sink mode). This input terminal may be programmed to any of the functions listed in [Table 5 on pg. 234](#) (see [F118](#)).

RR — The default function assigned to this terminal is **Frequency Mode 1**. The **RR** terminal accepts a 0 – 10 VDC input signal that is used to control the function assigned to this terminal. This input terminal may be programmed to control the speed or torque of the motor via an amplitude setting or regulate by setting a limit. The gain and bias of this terminal may be adjusted for application-specific suitability (see [F210 – F215](#)). See [pg. 26](#) for an electrical depiction of the **RR** terminal.

RX — The default function assigned to this terminal is **Torque Command**. The **RX** terminal accepts a ±10 VDC input signal that is used to control the function assigned to this terminal. This input terminal may be programmed to raise or lower the speed or torque of the motor via an amplitude setting or this terminal may be used to regulate the speed or torque of a motor by setting a limit. The gain and bias of this terminal may be adjusted for application-specific suitability (see [F216 – F221](#)).

V/I — The V/I terminal has the dual function of being able to receive an input voltage or current. The function as a voltage input is to receive a 0 – 10 VDC input signal. The function as a current input is to receive a 0 – 20 mA input signal. Using either input type, the function is to control the 0.0 – Maximum Frequency output or the 0.0 to 250% torque output of the ASD. This is an isolated input terminal. This terminal may be programmed to control the speed or torque of the motor and cannot process both input types simultaneously. **SW301** must be set to V or I to receive a voltage or current, respectively (see [Figure 9 on pg. 24](#)). Terminal scaling and the selection of speed or torque control is accomplished via parameters **F201 – F206**. The gain and bias of this terminal may be adjusted for application-specific suitability (see [F470](#) and [F471](#)).

SU+ — **Control Power Supply Backup** input terminal. This terminal accepts the user-supplied 24 VDC backup power to the control circuits (only). Backup power is used in the event of an open MCCB or during a momentary loss of the 3-phase input power. Parameter settings, real-time clock information, and trip history information are retained with the use of the **SU+** backup power. See the section titled [Battery Backup on pg. 28](#) for more information on system backup features.

P24 — +24 VDC at 200 mA power supply for customer use.

PP — The function of output **PP** is to provide a 10 VDC/10 mADC (max.) output that may be divided using a potentiometer. The tapped voltage is applied to the **RR** input to provide manual control of the **RR** programmed function.

O1A/B (OUT1A/B) — The default function assigned to this terminal is **Output Low-Speed**. This output may be programmed to provide an indication (open or closed) that any of the functions listed in [Table 8 on pg. 239](#) has occurred or is active. This function may be used to signal external equipment (e.g., activate the brake) (see [F130](#)). The **OUT1** terminal is rated at 2 A/120 VAC and 2 A/30 VDC.

O2A/B (OUT2A/B) — The default function assigned to this terminal is **ACC/DEC Complete**. This output may be programmed to provide an indication (open or closed) that any of the functions listed in [Table 8 on pg. 239](#) has occurred or is active. This function may be used to signal external equipment (e.g., activate the brake) (see [F131](#)). The **OUT2** terminal is rated at 2A/120 VAC and 2A/30 VDC.

FP — The default function of this output terminal is to output a series of pulses at a rate that is a function of the ASD output frequency (50 mA max. at 1.0 kHz to 43.3 kHz). As the output frequency of the ASD goes up so does the **FP** output pulse rate. This terminal may be programmed to provide an output pulse rate that is proportional to the magnitude of the user-selected item from [Table 6 on pg. 237](#). For further information on this terminal see [F676 on pg. 193](#).

AM — This output terminal produces an output current that is proportional to the output frequency of the ASD or of the magnitude of the function assigned to this terminal. The available assignments for this output terminal are listed in [Table 6 on pg. 237](#). For further information on this terminal see [F670 on pg. 192](#).

FM — This output terminal produces an output current or voltage that is proportional to the output frequency of the ASD or of the magnitude of the function assigned to this terminal. The available assignments for this output terminal are listed in [Table 6 on pg. 237](#). For further information on this terminal see [F005 on pg. 78](#). The Voltage/Current output selection is performed at [F681](#).

FLA — One of two normally open contacts that, under user-defined conditions, connect to **FLC**.

FLB — One of two normally closed contacts that, under user-defined conditions, connect to **FLC**.

FLC — **FLC** is the common leg of a single-pole double-throw form C relay. The **FL** relay is the **Fault Relay** by default, but may be programmed to any of the selections of [Table 8 on pg. 239](#). For further information on this terminal see [F132](#) and [Figure 8](#).

Note: The **FLA**, **FLB**, and **FLC** contacts are rated at 2A/120 VAC and 2A/30 VDC.

Figure 8. FLA, FLB, and FLC Switching Contacts Shown in the Normal Operating Condition.

Note: The relay is shown in the normal operating condition. During a **faulted** condition the relay connection is **FLC-to-FLA**.

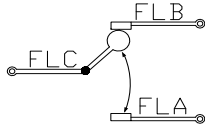
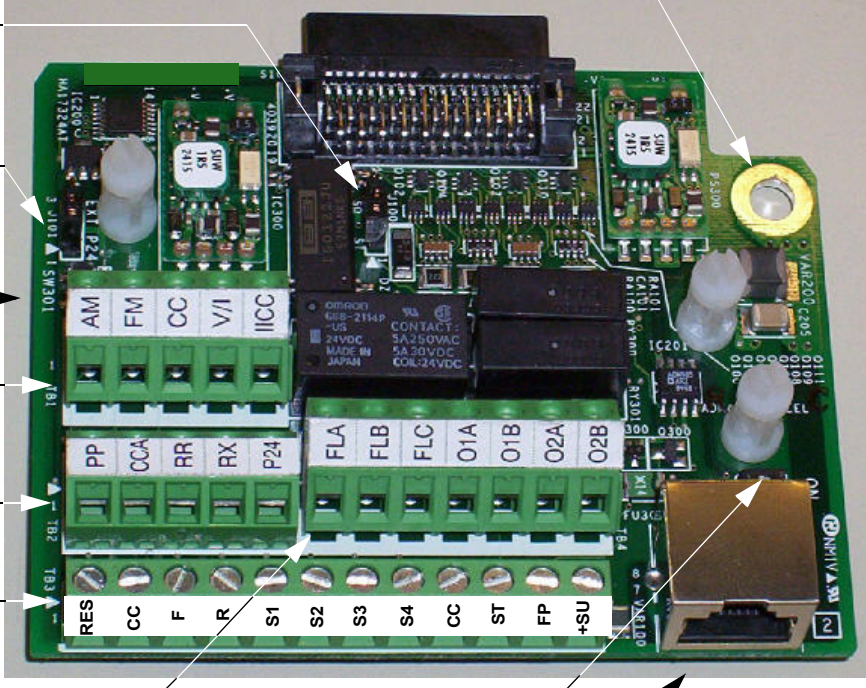

Figure 9. Terminal Board.

CAUTION Ensure that the ground screw is securely in place to prevent arcing, intermittent operation, or system failure.



J100
1 to 2 = Sink (*)
2 to 3 = Source

J101 (24V)
1 to 2 = Sys. Supplied (*)
2 to 3 = Ext. Supplied

SW301
V/I Switch (*)

TB1

TB2

TB3

TB4

SW200
Half / Full Duplex (*) Switch

S4
RS485 4-Wire Communication

* = Default Setting

See [Typical Connection Diagram on pg. 26](#) for more information on the Terminal

See the section titled [Terminal Descriptions on pg. 22](#) for terminal descriptions.

See the section titled [Cable/Terminal/Torque Specifications on pg. 264](#) for information on the proper cable/terminal sizes and torque specifications when making **Terminal Board** connections.

I/O Circuit Configurations

Figure 10. Discrete Input.

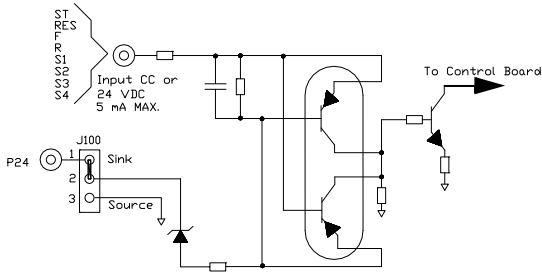

Figure 11. RR Input.

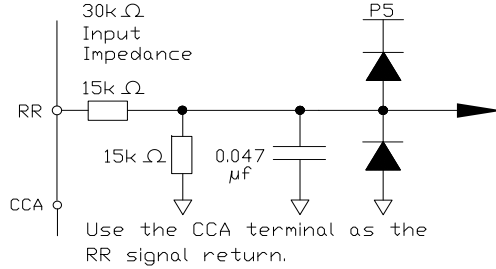

Figure 12. RX Input.

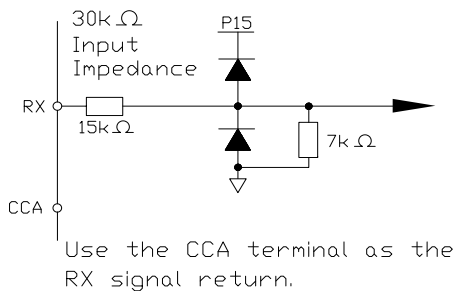

Figure 13. V/I Isolated Input.

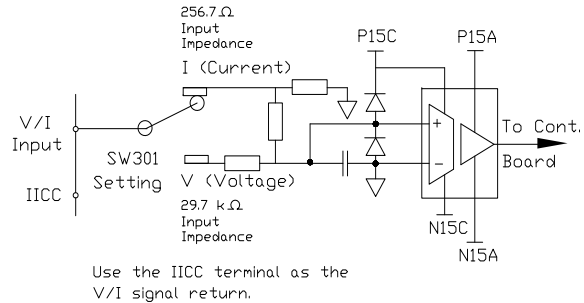

Figure 14. P24 Output.

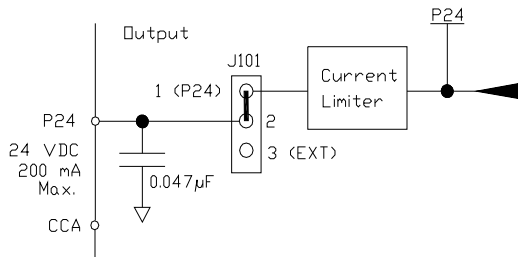

Figure 15. PP Output.

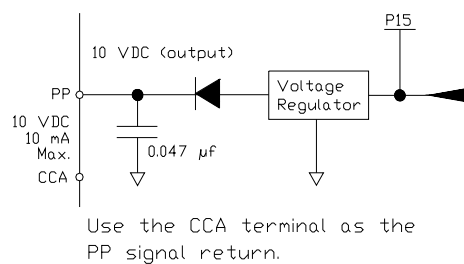

Figure 16. OUT1/OUT2 Output.

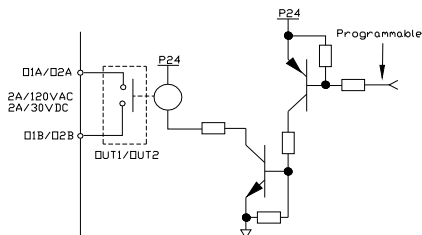

Figure 17. FP Output.

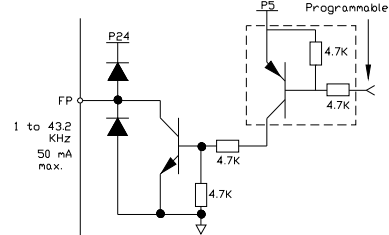

Figure 18. AM/FM Output.

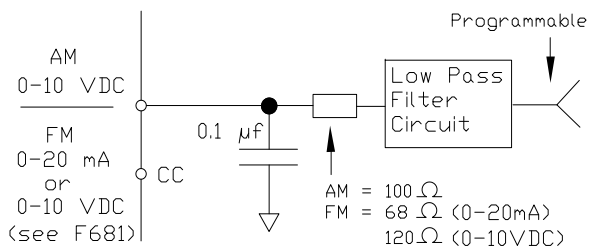
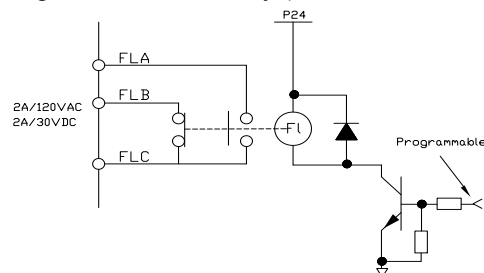

Figure 19. Fault Relay (shown not faulted).



Typical Connection Diagram

Figure 20. The H9 ASD Typical Connection Diagram.

Note: When connecting multiple wires to the PA, PB, PC, or PO terminals, do not connect a solid wire and a stranded wire to the same terminal.

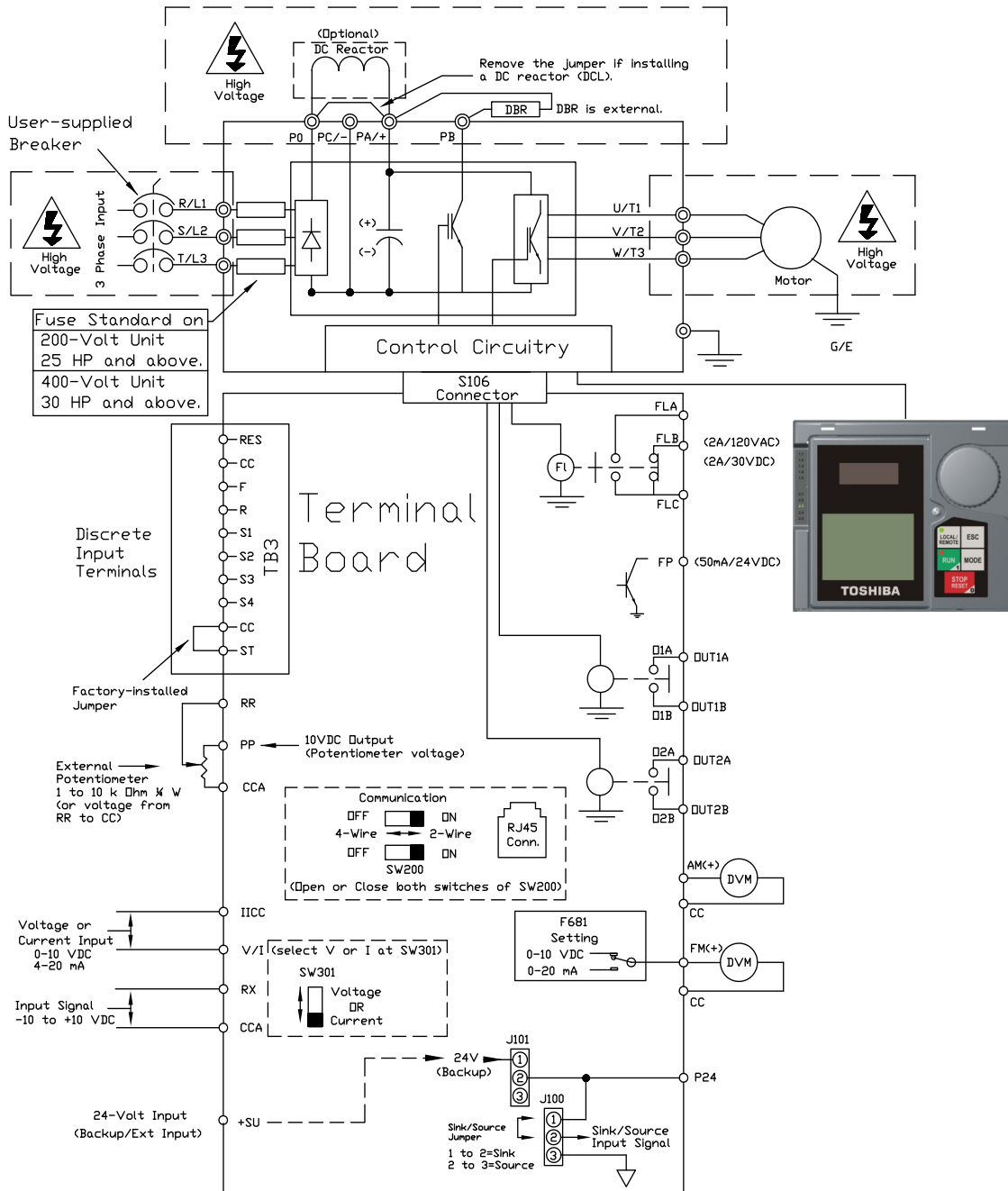

Note: The AM, FM, and the +SU analog terminals are referenced to CC.
 The RR, RX, P24, and the PP analog terminals are referenced to CCA.
 The isolated V/I analog terminal references IICC.

Startup and Test



DANGER

Before turning on the ASD ensure that:

- **R/L1, S/L2, and T/L3** are connected to the 3-phase input power.
- **U/T1, V/T2, and W/T3** are connected to the motor.
- The 3-phase input voltage is within the specified tolerance.
- There are no shorts and all grounds are secured.
- All personnel are at a safe distance from the motor and the motor-driven equipment.

Electronic Operator Interface

The H9 ASD **Electronic Operator Interface** (EOI) is comprised of an LED screen, an LCD screen, two LEDs, a rotary encoder, and five keys. These items are shown and described on [pg. 30](#).

EOI Operation

The **EOI** is the primary input/output device for the user. The **EOI** may be used to monitor system functions, input data into the system, perform diagnostics, and view performance data (e.g., motor frequency, bus voltage, torque, etc.).

The software used with the H9 ASD is menu driven; thus, making it a select and click environment. The operating parameters of a motor may be selected and viewed or changed using the **EOI** (or via communications).

Battery Backup

The EOI is equipped with a battery backup system. The function of the backup system is to retain the EOI SRAM programming in the event of a power outage, or if an EOI removal and installation from one system to another is required without the loss of programming.

Listed below are the items retained by the battery backup system:

[Trip History](#),

[EOI Contrast](#),

[Real-Time Clock](#) Information,

[Monitored Items](#),

[Password and Lock Out](#) Information,

[Alarms](#) Information,

[Main Monitor](#) Items,

[Prohibited](#) Items, and

[Save User Settings](#) Information (Parameter settings may be saved by the user).

The battery backup system must be activated by the installer or maintenance personnel to use the backup function.

To activate the battery backup system, remove the Phillips screw from the front of the LED/LCD display unit. Remove the LED/LCD display unit from the ASD. From the circuit side of the display unit, remove the jumper at **J1**, pins **2** and **3**. Place the jumper at **J1**, pins **1** and **2**.

The expected battery life cycle is four and a half years.

Note: *The Battery backup system does not supply power to the LED/LCD display*

LED/LCD Screen Installation Note

When installing the LED/LCD display unit of the EOI, ensure that the left side of the display is inserted first with the top and bottom catches (see Phillips screws at underside of display) securely in place. This ensures the proper alignment and electrical connection of the CNX connector of the LED/LCD display unit PCB. Gently hold the display in place while securing the Phillips mounting screw.

If improperly seated, the periphery of the LED/LCD display unit will not be flush with the EOI surface and the unit will not function properly.

EOI Remote Mounting

The EOI may be mounted remotely using the optional **ASD-MTG-KIT9**. The kit contains all of the hardware required to mount the EOI of the 9-Series ASD remotely.

System operation and EOI operation while using the remotely-mounted EOI are the same as with the ASD-mounted configuration.

See the section titled [EOI Remote Mounting on pg. 33](#) for more information on mounting the EOI remotely.

EOI Features

Figure 21. The H9 ASD Electronic Operator Interface Features.

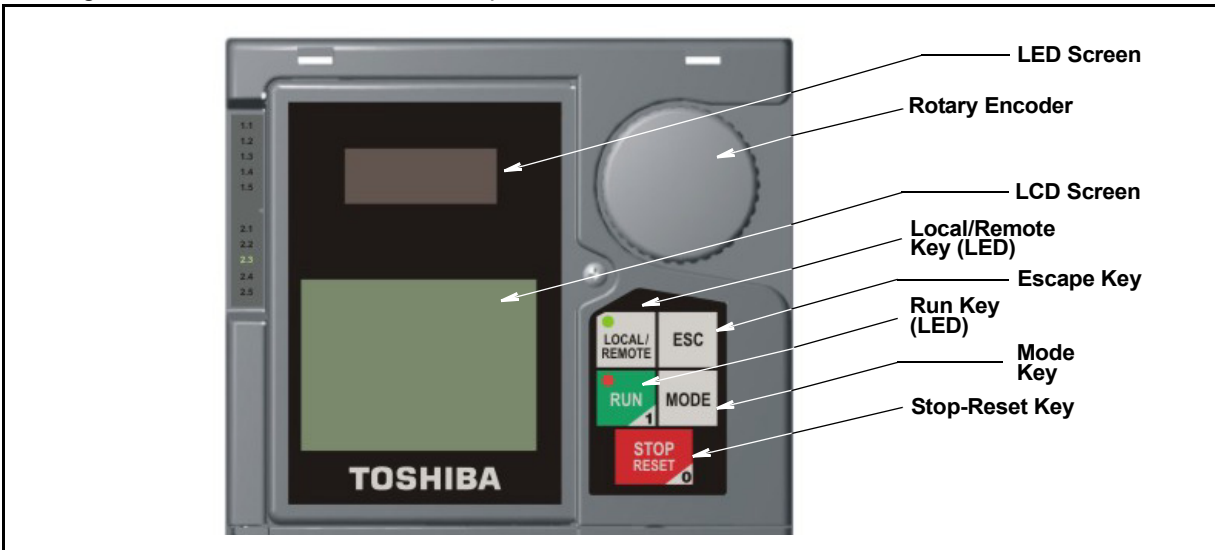

LED Screen — Displays the running frequency, active **Fault**, or active **Alarm** information.

Rotary Encoder — Used to access the H9 ASD menu selections, change the value of a displayed parameter, and performs the **Enter** key function. Turn the **Rotary Encoder** either clockwise or counterclockwise to perform the **Up** or **Down** functions of the displayed menu selection. Press the **Rotary Encoder** to perform the **Enter** (select) function. Press while turning for times-ten increment/decrement.

LCD Screen — Displays configuration information, performance data (e.g., output frequency, bus voltage, torque, etc.), diagnostic information, and **LED** screen information in expanded normal text.

Local/Remote Key — Toggles the system to and from the **Local** and **Remote** modes. The **Local/Remote** key is disabled while the **Fault** screen is active. The **Local/Remote** key LED is on when the system is in the **Local** mode. The **Local** mode allows the **Command** and **Frequency** control functions to be carried out via the **EOI**.

The **Remote** mode enables the **Command** and **Frequency** control functions to be carried out via the **Terminal Board**, **RS485**, **Communication Board**, **Pulse Input**, or the settings of **F003/F004**. The (**F003/F004**) selection may be made via Program ⇒ Fundamental ⇒ Standard Mode Selection ⇒ **Command Mode** and **Frequency Mode 1**, respectively.

The availability of **Local** mode control (**Command** and **Frequency** control) may be disabled via Program ⇒ Utilities ⇒ Prohibition ⇒ **Local/Remote Key Command Override** and **Local/Remote Key Frequency Override**. The availability of the **Local** mode of operation may be reinstated by changing this setting or performing a **Reset** (see **F007**).

ESC Key — Returns the system to the previous level of the menu tree, toggles between the **EOI Command** screen and the **Frequency Command** screen, or cancels changes made to a field if pressed while still in the reverse video mode (dark background/light text). The three functions are menu-specific.

Run Key — Issues the **Run** command while in the **Local** mode. The **Run** key LED illuminates green while stopped or red while running to alert personnel.

Mode Key — Provides a means to access the three root menus. Pressing the **Mode** key repeatedly loops the system through the three root menus (see [Figure 27 on pg. 41](#)). While looping through the root menus, the **Program** menu will display the root menu screen or the **Program** sub-menu item being accessed prior to pressing the **Mode** key.

Stop-Reset Key — This key has three functions.

1. Issues the **Off** command (decelerates to **Stop** at the programmed rate) if pressed once while in the **Local** mode in accordance with the setting of **F721**.
2. Initiates an **Emergency Off Fault** if pressed twice quickly from the **Local** or **Remote** modes. The **Emergency Off** function terminates the H9 ASD output and stops the motor in accordance with the setting of **F603**.
3. Resets active **Faults** and/or active **Alarms** if pressed twice quickly. The source of the **Faults** or **Alarms** must be determined and corrected before normal ASD operation can resume.

LED/LCD Screen

The LED screen is used to display the output frequency, active alarms and/or active faults.

If there are no active alarms or faults, the output frequency is displayed.

During an active alarm, the display toggles to and from the running frequency and the active alarm.

During an active fault, the fault is displayed.

Loss of the **ST-to-CC** connection flashes **Off**.

LED Character/Font Information

Characters displayed on the LED screen will be of the seven-segment format. Not all alpha-numeric characters are used with the LED screen.

Listed are the seven-segment characters used with the LED screen along with the same characters as they are displayed on the LCD screen.

LCD Character/Font Information

All alpha-numeric characters are available.

LED/LCD Screen Information			
LED	LCD	LED	LCD
À	A	1	1
À	b	2	2
À	C	3	3
À	d	4	4
À	E	5	5
À	F	6	6
À	G	7	7
À	H	8	8
À	I	9	9
À	J	0	0
À	L		
À	M		
À	n		
À	O		
À	P		
À	q		
À	r		
À	S		
À	t		
À	U		
À	v		
À	y		
-	-		

LCD Screen

The **LCD** screen is the primary user input/output information center. Parameter settings may be viewed or changed using the LCD display unit of the **EOI**. To view or change a parameter setting using the LCD screen, press the **Mode** key until the **Program** menu is displayed. Turn the **Rotary Encoder** until the desired **Primary Menu** item (see [pg. 46](#)) is within the cursor block. Press the **Rotary Encoder** to select the item from the **Primary Menu** (repeat the press-to-select for submenu items).

See the section titled [Default Setting Changes on pg. 74](#) for more information on changing parameter settings.

Upon reaching the desired parameter selection, the current setting may be viewed, or selected and changed by pressing the **Rotary Encoder** and the setting will take on the reverse video format (dark background/light text). Turn the **Rotary Encoder** to change the parameter setting. Press the **ESC** key while the new parameter setting is in the reverse video mode to exit the selection without saving the change or press the **Rotary Encoder** while the parameter setting is in the reverse video mode to accept the change.

Repeated **ESC** key entries at any time takes the menu back one level each time the **ESC** key is pressed until the **Frequency Command** screen is reached. Further **ESC** entries will toggle the system to and from the **Frequency Command** screen and the **EOI Command** menu.

*Note: Changes carried out from the **EOI Command** screen will be effective for EOI-controlled ASD operation only. See the section titled [EOI Command Mode on pg. 42](#) for further information on **EOI Command Mode** operations.*

Primary Menus of the LCD Screen

The three primary screens of the LCD screen are displayed while accessing the associated operating mode: the **Frequency Command**, **Monitor**, and the **Program Menu** screens.

Figure 22. **Frequency Command** Screen.

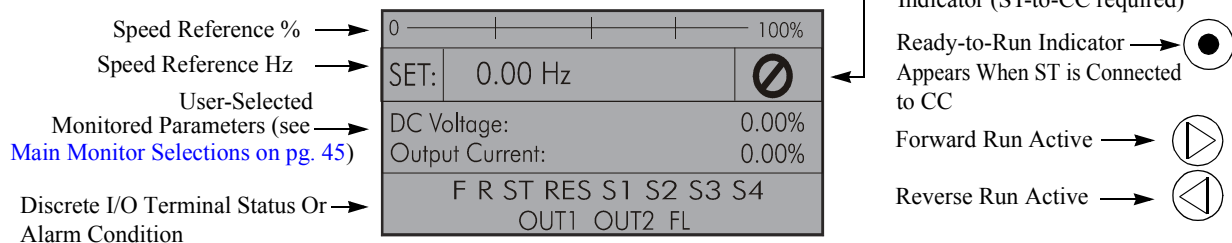

Figure 23. **Monitor** Screen (see [pg. 43](#) for more on the Monitor screen items).

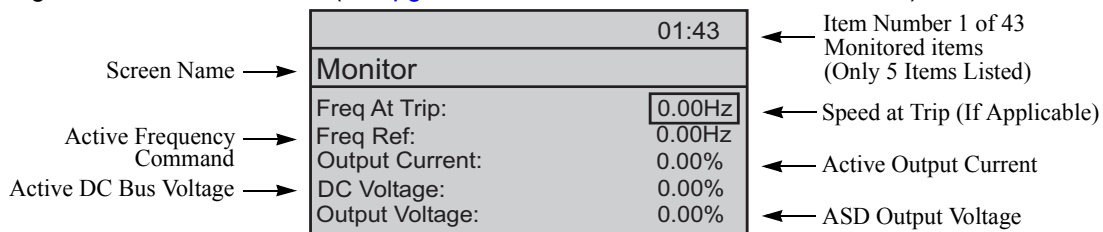
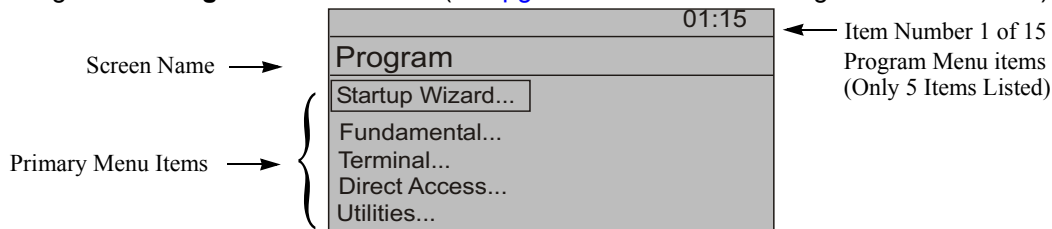

Figure 24. **Program Menu** Screen (see [pg. 46](#) for more on the Program Menu Screen).



EOI Remote Mounting

The H9 ASD may be controlled from a remotely-mounted EOI. For safety and application-specific reasons, some ASD installations will warrant that the operator not be in the vicinity during operation or that the EOI not be attached to the ASD housing. Remote mounting will also allow for multiple EOI mountings at one location if controlling and monitoring several ASDs from a central location is required.

The door-mounted EOI of the 230-volt 30-HP and above ASDs and the 460-volt 40 HP and above ASDs use the remote mounting kit **58333** to allow for the door-mount EOI configuration.

The ease of installation and mounting distance away from the ASD may be increased with the use of the optional remote mounting kit **ASD-MTG-KIT9**.

An EOI extender cable is required for remote mounting. The EOI extender cable is available in a 10-ft. length and may be ordered through your TIC Sales Representative. Remote mounting may be extended up to the distance supported by standard RS485 communication — typically 4000 feet (1200 meters) maximum.

The optional dust cover (P/N ASD-BPC) may be used to cover the EOI opening of the ASD housing after removing the EOI.

Remote EOI Hardware

EOI Mounting Hardware

- EOI Remote-Mount Housing — P/N 58333 (included with the 230-volt 30-HP and above; and with the 460-volt 40 HP and above)
- 6-32 x 5/16” Pan Head Screw — P/N 50595 (4 ea.)
- #6 Split-Lock Washer — P/N 01884 (4 ea.)
- #6 Flat Washer — P/N 01885 (4 ea.)

Bezel Plate Mounting Hardware

- Bezel Plate — P/N 52291
- 10-32 Hex Nut — P/N 01922 (4 ea.)
- #10 Split-Lock Washer — P/N 01923 (4 ea.)
- #10 Flat Washer — P/N 01924 (4 ea.)
- Dust Cover — P/N ASD-BPC (Optional)

Extender Cable

- ASD-CAB10F: Cable, 10 ft.

EOI Remote Mounting Using the ASD-MTG-KIT9

Note: See [Figure 26](#) for the dimensions and the item locations referenced in steps 1 through 6.

1. At the EOI mounting location, mark the 4.60" by 4.50" hole and the four 11/32" screw holes.
2. Cut the 4.60" by 4.50" rectangular hole.
3. Drill the four 11/32" holes for the Bezel Plate mount.
4. Attach and secure the Bezel Plate to the front side of the mounting location using the four 10-32 hex nuts, #10 split lock washers, and the #10 flat washers.
5. Attach and secure the EOI to the front side of the Bezel Plate using the four 6-32 x 5/16" pan head screws, #6 split lock washers, and the #6 flat washers.
6. Connect the extension cable.

EOI ASD-MTG-KIT9 Mounting Dimensions

Figure 26. EOI Bezel Plate Mounting Dimensions.

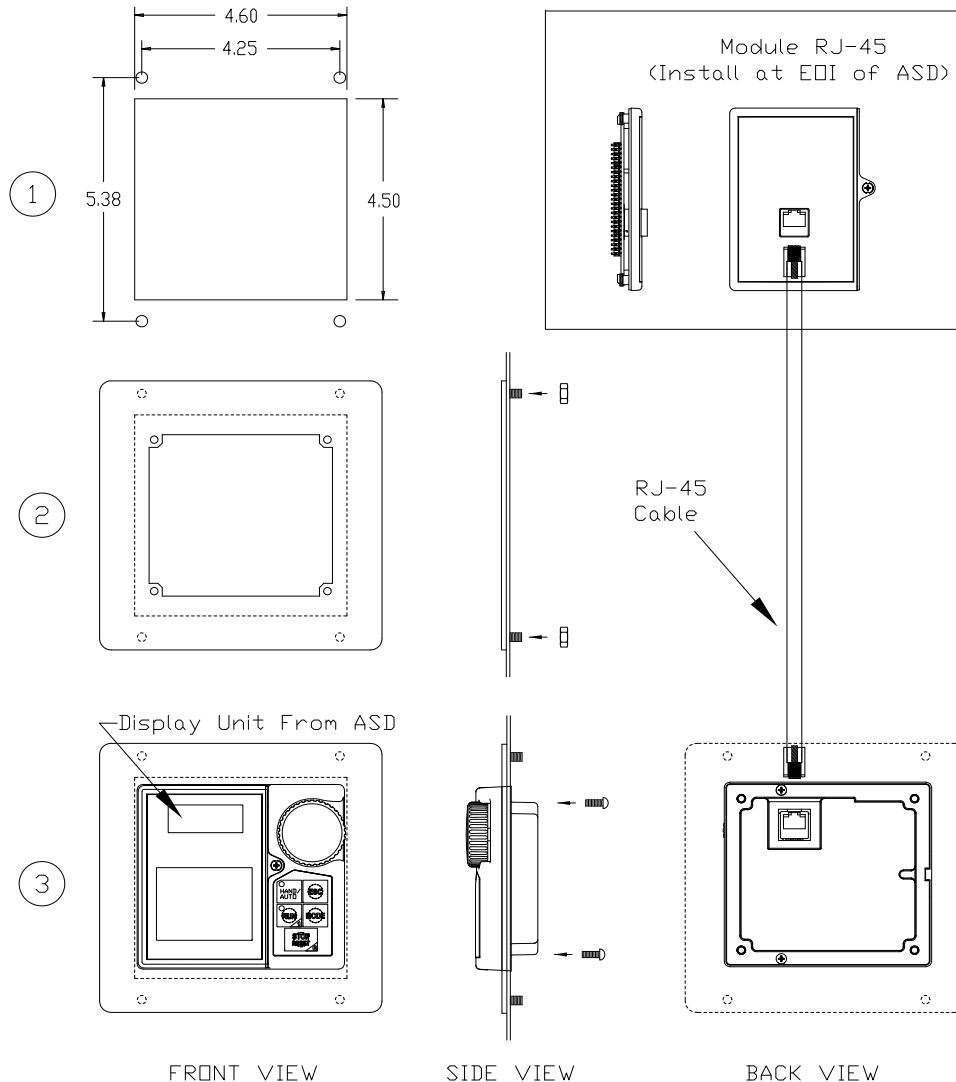

Command Mode and Frequency Mode Control

Command control includes instructions such as **Stop**, **Run**, **Jog**, etc. The source of the **Command** signal must be established for normal operation.

Frequency commands control the output speed of the H9 ASD. The source of the frequency control signal must be established for normal operation.

The source of the command control and frequency control may be either internal or external. Once the source signal is selected for either function, the system may be configured to use the selected signal all of the time or switch under user-defined conditions.

Command and **Frequency** control may be carried out using any one of several control methods (signal sources) or combinations thereof. In the event that multiple control commands are received, the signal sources are assigned priority levels. The primary control method for **Command** and **Frequency** control uses the settings of **F003** and **F004**, respectively.

Command Control (F003)

The **Command Mode** selection of **F003** establishes the primary source of the command input for the ASD. However, the **Override** feature may supersede the **F003** setting as indicated in [Table 3](#).

[Table 3 on pg. 38](#) shows the hierarchy of the control sources managed by the **Override** function. The level of the control item of the hierarchy is listed from left to right, most to least, respectively. As indicated in the table, the **Override** setting may supersede the **F003** setting.

Placing the EOI in the **Local** mode selects the **RS485** (2-wire) as the **Command Mode** control source. **Local** mode operation may be superseded by other **Override** settings.

Example: With the EOI set to **Local**, **Communication Board** input or **RS485** (4-wire) input will supersede EOI control input.

The remaining control sources may be placed into the **Override Mode** using communications.

The source of the **Command** control signal may be selected by:

- The **F003** setting,
- Placing an item from the **Command** signal source selections in the **Override Mode** via communications, or
- Placing the EOI in the **Local** mode (places only the RS485 [2-wire] or the RS485 [4-wire] in the **Override Mode**).

Possible **Command** signal source selections include the following:

- Terminal Block (default),
- EOI (Keypad),
- RS485,
- Communication Option Board, or
- **F003** setting (is used if no signal sources are in the **Override Mode**).

Note: *The **Terminal Board** is placed in the **Override Mode** for **Command** functions by assigning a discrete terminal to **Command Terminal Board Priority** and connecting the terminal to **CC**. Once activated (Run command required), the **Terminal Board** settings will be used for **Override Command** control (F, R, Preset Speeds, etc.).*

01:06
Standard Mode Selection
(F003) Command Mode Selection
Terminal Block

Frequency Control (F004)

02:06
Standard Mode Selection
(F004) Frequency Mode 1
RR

The **Frequency Mode 1** (or the Frequency Mode 2) setting establishes the user-selected source of the frequency-control input for the H9 ASD. The signal source selected here is used for speed control unless the **Reference Priority Selection** parameter is configured to switch this setting automatically (see F200) or if the **Override** feature is enabled.

Table 3 on pg. 38 shows the hierarchy of the control sources managed by the **Override** function. The level of the control item of the hierarchy is listed from left to right, most to least, respectively. As indicated in the table, the **Override** setting may supersede the selection at F004.

Placing the EOI in the **Local** mode selects the **RS485** (2-wire) as the **Frequency Mode 1** control source. **Local** mode operation may be superseded by other **Override** settings.

Example: With the EOI set to **Local**, the **Communication Board** input or the **RS485** (4-wire) input will supersede EOI control input.

The remaining control sources may be placed into the **Override Mode** using communications.

The source of the **Frequency** control signal may be selected by:

- The **F004** setting,
- Placing an item from the **Frequency** control source selections in the **Override Mode** via communications, or
- Placing the EOI in the **Local** mode (places only the **RS485** [2-wire] in the **Override Mode**).

Possible **Frequency** control source selections include the following:

- Communication Board,
- RS485,
- EOI (Keypad),
- Terminal Block (the default setting), or
- **F004** setting (used if no other items are in the **Override mode**).

Note: The **Terminal Board** is placed in the **Override Mode** for **Speed** control functions by assigning a discrete terminal to **V/I Terminal Priority** and connecting the terminal to **CC**. Once the discrete terminal is activated, **V/I** is used as the **Terminal Board Override** control item.

Command and Frequency Control Selections

The user may select only one **Command** source and only one source for **Frequency** control. The default settings for **Command** and **Frequency** control are **Terminal Block** and **RR**, respectively.

The H9 ASD has a command register for each item listed as a **Command** or **Frequency** source. The registers store the **Override** setting for each control source. The registers are continuously scanned to determine if any of the listed items are in the **Override Mode**.

For each scan cycle, the command registers of the control sources are scanned for the **Override** setting in the order that they are listed in Table 3. The first item of the **Command** section and the first item of the **Frequency** section detected as being in the **Override Mode** will be used for **Command** and **Frequency** control, respectively. If no items are detected as being in the **Override Mode**, the settings of **F003** and **F004** will be used for **Command** and **Frequency** control, respectively.

Any or all of the **Command** and **Frequency** control input sources may be placed in the **Override Mode**.

Placing the H9 ASD in the **Local** mode (Local/Remote LED on) via the EOI places the **RS485** (2-wire) control selection in the **Override Mode** for **Command** and **Frequency** input (see the section titled [Override Operation on pg. 38](#) for the proper setting). The **Local/Remote** control **Override** feature for **Command** and **Frequency** (or either) may be enabled/disabled at Program ⇒ Utilities ⇒ Prohibition ⇒ **Local/Remote Key** (Command or Frequency) **Override**.

Communications may be used to place the remaining **Command** and eligible **Frequency** control input sources in the **Override Mode**. Once placed in the **Override Mode** this setting is valid until it is cancelled, the power supply is turned off, or the H9 ASD is reset.

Override Operation

The signal sources of [Table 3](#) are scanned from left to right in the order that they are listed to determine which input sources are in the **Override Mode** (active Command or Frequency command present). The first item detected as having the **Override** function turned on is the selection that is used for **Command** or **Frequency** control input.

The **Override** control setting supersedes the setting of the **Command** mode setting (**F003**) and the **Frequency** mode setting (**F004**). However, the **F003** and **F004** settings will be used in the event that the register scan returns the condition that none of the listed items have the **Override** feature turned on or a discrete input terminal is set to **Serial/Local Switch** and is activated.

Command and Frequency-Control Override Hierarchy

[Table 3](#) lists the input conditions and the resulting output control source selections for **Command** and **Frequency** control **Override** operation.

From left to right in [Table 3](#), the active signal source has priority over any adjacent active signal sources to the right.

Table 3. Command and Frequency Control Hierarchy.

1	2	3	4	5	6	Priority Level
Forced F003/ F004 by I/P Terminal (Assign to Serial/ Local Switch)	Comm. Board	RS485 (4-Wire)	RS485 (2-Wire)	Terminal Board (Binary/BCD Input)	F003/F004	Command/ Frequency Mode
1	X	X	X	X	X	F003/F004 Setting
0	1	X	X	X	X	Communication Board
0	0	1	X	X	X	RS485 (4-Wire)
0	0	0	1	X	X	RS485 (2-Wire)
0	0	0	0	1	X	Terminal Board
0	0	0	0	0	F003/F004 Setting	F003/F004 Setting

Note: 1 = Override feature is turned on for that control input source; 0 = Override Off; X = Don't Care.

Command Control Selections

The following is a listing with descriptions of the **Command Mode (F003)** selections (Program ⇒ Fundamental ⇒ Standard Mode Selection ⇒ **Command Mode Selection**).

Settings:

0 — Terminal Block

Allows for **Command** control input via the **Terminal Board**.

1 — Not Used

Unused.

2 — EOI (Keypad)

Used for EOI command control.

3 — RS485

Used to transfer commands to the ASD via 4-wire RS485.

4 — Communication Option Board

Use this setting if using the optional **Communication Board** for command control.

01:06
Standard Mode Selection
(F003) Command Mode Selection
Terminal Block ← (Default)

Frequency Control Selections

The following is a listing with descriptions of the **Frequency Mode (F004)** selections (Program ⇒ Fundamental ⇒ Standard Mode Selection ⇒ **Frequency Mode 1**).

Settings:

1 — V/I

Used when a 0 to 10 VDC analog input or a 0 – 20 mADC current input is used as the speed control input. Only one input signal type may be used at a time. Set [SW301](#) to the desired signal type.

2 — RR

Used for a 0 to 10 VDC analog input signal.

3 — RX

Used for a -10 to +10 VDC analog input signal.

4 — Not Used

Unused.

5 — EOI (Keypad)

Used for EOI frequency control.

6 — RS485

Used to transfer speed commands to the ASD via 4-wire RS485.

02:06
Standard Mode Selection
(F004) Frequency Mode 1
RR ← (Default)

7 — Communication Option Board

Use this setting if using the optional **Communication Board** for frequency control.

8 — RX2 Option (AI1)

Used for a -10 to +10-volt DC analog input signal.

9 — Option V/I

Allows for the use of the optional voltage/current frequency-control interface.

10 — UP/DOWN Frequency

A discrete terminal may be configured to increase or decrease the speed of the motor by momentarily connecting the assigned discrete input terminal to **CC**. See [F264 on pg. 128](#) for further information on this feature.

11 — Pulse Input Option

Used to allow the system to use a pulsed input for frequency control. See [PG Input Point 1 Setting on pg. 122](#) for further information on this feature.

12 — Pulse Input (motor CPU)

Used to allow the system to use a pulsed input for frequency control. See [PG Input Point 1 Setting on pg. 122](#) for further information on this feature.

13 — Binary/BCD Input Option

Allows for the discrete terminals to be used for frequency-control input. Input may be provided as binary or binary coded decimal.

System Configuration and Menu Options

Root Menus

The **Mode** key accesses the three primary modes of the H9 ASD: the **Frequency Command** mode, the **Monitor** mode, and the **Program** mode. From either mode, press the **Mode** key to loop through to the other two modes (see [Figure 27](#)). While in the **Frequency Command** mode, pressing the **ESC** key toggles the menu to and from the **EOI Command** mode and the **Frequency Command** mode.

The **Alarm** or **Fault** information will be displayed in the event of an active **Alarm** or **Fault**. **Alarm** text will be displayed on the **Frequency Command** screen and on the LED screen when active. **Fault** information will be displayed via the **Fault** screen. See [Alarms and Trips on pg. 244](#) for more information on **Alarms** and **Trips**.

Figure 27. H9 ASD Root Menu Navigation.

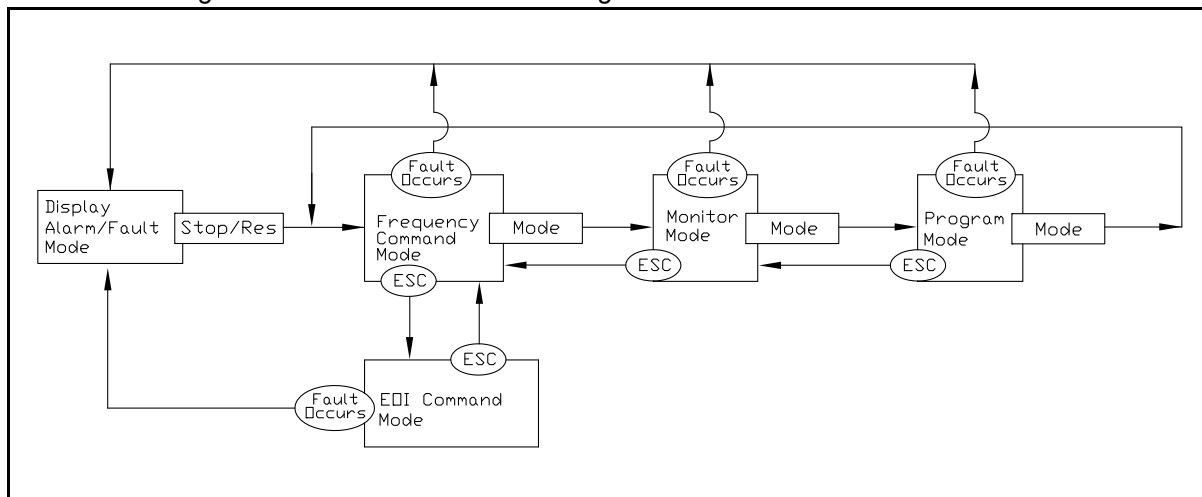

Frequency Command Mode

Frequency Setting

While operating in the **Local** mode (**Local** LED is illuminated on the EOI), the running frequency of the motor may be set from the **Frequency Command** screen. Using the **Rotary Encoder**, enter the **Frequency Command** value, connect **ST** to **CC**, and provide a **Run** command (F and/or R) and then press the **Run** key. The motor will run at the **Frequency Command** speed and may be changed while running. See [Figure 22 on pg. 32](#) and [Operation \(Local\) on pg. 73](#) for more information on the **Frequency Command** mode.

EOI Command Mode

The **EOI Command** mode is accessed by pressing the **ESC** key from the **Frequency Command** screen.

The control settings of the **EOI Command** menu are effective for **EOI** control only.

The **EOI Command** mode provides quick access to the following menu parameters:

Direction — **Forward** or **Reverse**.

Stop Pattern — The **Decel Stop** or **Coast Stop** settings determines the method used to stop the motor when using the **Stop-Reset** key of the **EOI**. The **Decel Stop** setting enables the **Dynamic Braking** system setup at [F304](#) or the **DC Injection Braking** system setup at [F250](#), [F251](#), and [F252](#). The **Coast Stop** setting allows the motor to stop at the rate allowed by the inertia of the load.

Note: The **Stop Pattern** setting has no effect on the **Emergency Off** settings of [F603](#).

V/f Group — One of 4 **V/f** profiles may be selected and run. Each **V/f** profile is comprised of 4 user settings: **Base Frequency**, **Base Frequency Voltage**, **Manual Torque Boost**, and **Electronic Thermal Protection**. Expanded descriptions of these parameters may be found in the section titled [Direct Access Parameter Information on pg. 76](#).

Accel/Decel Group — One of 4 **Accel/Decel** profiles may be selected and run. Each of the **Accel/Decel** profiles is comprised of three user settings: **Acceleration**, **Deceleration**, and **Pattern**. Expanded descriptions of these parameters may be found in the section titled [Direct Access Parameter Information on pg. 76](#) (or see [F009](#)).

Feedback in Panel Mode — This feature enables or disables the **PID** feedback function.

Torque Limit Group — This parameter is used to select 1 of 4 preset positive torque limits to apply to the active motor (of a multiple motor configuration). The settings of profiles 1 – 4 may be setup at [F441](#), [F444](#), [F446](#), and [F448](#), respectively.

Monitor Mode

The **Monitor** mode allows the user to monitor motor performance variables, control settings, and configuration data during motor operation. There are 43 items that may be monitored from this mode. The items are listed and described below.

Note: The **Monitor** mode is a read-only mode. The settings cannot be changed from the **Monitor** mode. For information on how to change the values, see the section titled [Default Setting Changes on pg. 74](#).

Note: Any two of the Underlined monitored items may be selected for display at the **Frequency Command** screen while running via Program ⇒ Utilities ⇒ [Main Monitor Selections](#).

Note: The **F701** setting will determine if the **Current** and **Voltage** values displayed appear as **A (Amps)** and **V (Voltage)**, or if the value is shown as a % (percentage) of the **ASD** rating.

Frequency at Trip — Displays the at-trip frequency.

Frequency Reference — Displays the **Frequency Setpoint**.

Output Current — Displays the **Output Current** as a percentage of the rated capacity of the H9 ASD.

DC Bus Voltage — Displays the **Bus Voltage** as a percentage of the rated capacity of the H9 ASD.

Output Voltage — Displays the **Output Voltage** as a percentage of the rated capacity of the H9 ASD.

AM Output — Displays the **AM** output terminal value for the function assigned to the **AM** terminal.

FM Output — Displays the **FM** output terminal value for the function assigned to the **FM** terminal.

Motor OL (Overload) Real — Displays the real-time **Motor Overload** value as a percentage of the rated capacity of the motor.

Motor OL (Overload) Trip — Displays the **Motor Overload Trip** value as a percentage of the rated capacity of the motor.

Motor Load — Displays the real-time **Motor Load** as a percentage of the rated capacity of the motor.

ASD OL (Overload) Real — Displays the real-time **ASD Overload** as a percentage of the rated capacity of the H9 ASD.

ASD OL (Overload) Trip — Displays the **ASD Overload Trip** value as a percentage of the rated capacity of the ASD.

ASD Load — Displays the **ASD Load** as a percentage of the rated capacity of the H9 ASD.

Run Time — Displays the **Cumulative Run Time** in hours.

Compensation Frequency — Displays the **Output Frequency** after the application of the slip compensation correction value (Post Compensation Frequency).

DBR OL (Overload) Real — Displays the real-time **DBR Overload** value as a percentage of the **Dynamic Braking Resistor** capacity.

DBR OL (Overload) Trip — Displays the **DBR Overload Trip** value as a percentage of the **Dynamic Braking Resistor** capacity.

DBR Load — Displays the **DBR Load** as a percentage of the **Dynamic Braking Resistor** capacity.

Feedback (Inst) — Provides a status of the **Real Time Feedback** in Hz.

Feedback (1 Second) — Provides a status of the **1-Second Averaging** feedback in Hz.

Torque — Displays the **Output Torque** as a percentage of the rated capacity of the H9 ASD.

Torque Reference — Displays the **Torque Reference** as a percentage of the maximum torque available.

Torque Current — Displays the torque-producing current value.

Excitation Current — Displays the current value required to produce the excitation field.

PID Feedback — Provides a status of the **PID Real Time Feedback** in Hz.

Input Power — Displays the **Input Power** in Kilowatts (kW).

Output Power — Displays the **Output Power** in Kilowatts (kW).

Pattern Group Number — Displays the active **Pattern Run Group Number**.

Pattern Group Cycle — Displays the cycle number of the active **Pattern Run Group**.

Pattern Group Preset — Displays the active **Preset Speed** being run of the active **Pattern Run Group**.

Pattern Time — Displays the remaining time for the active **Pattern Run Group**.

RR — Displays the **RR** input value as a percentage of the full range of the **RR** value (potentiometer input).

V/I — Displays the **V/I** input setting as a percentage of the full range of the **V/I** value.

*Note: The isolated V/I input terminal may receive **Current** or **Voltage** to control the output speed or the output torque. The input signal type must be selected at [SW301](#) on the **Terminal Board**.*

The V input setting of [SW301](#) is used for the 0 – 10 VDC analog input signal and the I input setting of [SW301](#) is used for the 0 – 20 mA analog input signal. Either may be used as a frequency or torque command source. See parameter [F201](#) for more information on the setup of this terminal.

RX — Displays the **RX** input setting as a percentage of the full range of the **RX** value (-10 to +10 VDC input).

RX2 Option (AI1) — Displays the **RX2** input setting as a percentage of the full range of the **RX2** value.

*Note: The RX2 function is available on the **Expansion IO Card Option 1** option board (P/N ETB003Z) only.*

Trip Code — Displays **None** if there are no errors, or displays one of the associated **Fault Codes** listed in [Table 14 on page 248](#) if there is an active **Fault** (e.g., **E** = **Emergency Off**).

Past Trip 1 — This function records and displays the last trip incurred. Subsequent trips will replace **Past Trip 1**. As trip records are replaced they are shifted to the next level of the **Past Trip** locations until being deleted (i.e., **Past Trip 1** is moved to **Past Trip 2** and then to **Past Trip 3** until being shifted out of **Past Trip 4**). Once shifted out of **Past Trip 4** the record is deleted. If no trips have occurred since the last reset, **No Error** is displayed for each trip record.

Past Trip 2 — Past trip information or **None**.

Past Trip 3 — Past trip information or **None**.

Past Trip 4 — Past trip information or **None**.

Note: An improper H9 ASD setup may cause some trips — reset the H9 ASD to the **Factory Default** settings before pursuing a systemic malfunction (Program ⇒ Utilities ⇒ Type Reset ⇒ **Reset to Factory Settings**).

Direction — Displays the **Direction** command (forward/reverse).

Discrete Input Terminals — Displays the status (activated = reverse video) of the discrete input terminals of the **Terminal Board**.

Discrete Output Terminals — Displays the status (activated = reverse video) of the discrete output lines of the **Terminal Board**.

Main Monitor Selections

Two (2) **Monitor Mode** items may be selected from the **Main Monitor Selections** screen to be displayed on the **Frequency Command** screen while the H9 ASD is running.

The selected items, along with their real-time values, are displayed on the **Frequency Command** screen while running. Not all **Monitor Mode** items are available for display on the **Frequency Command** screen. The available items are underlined on [pg. 43](#) and [pg. 44](#).

Any two of the underlined items may be selected from the listing at Program ⇒ Utilities ⇒ **Main Monitor Selections**. Select an item from the **Monitor 1** listing and another item from the **Monitor 2** listing to be displayed as shown in [Figure 22 on pg. 32](#).

Program Mode Menu Navigation

The following table lists the menu items of the **Program** mode and maps the flow of the menu selections. The **Parameter Numbers** for the listed functions are provided where applicable.

The functions listed may be viewed, or selected and changed as mapped below or via the **Direct Access** method: Program ⇒ Direct Access ⇒ *Applicable Parameter Number*.

Program Mode Menu Navigation			
Primary Menu	Sub Menu	Parameter Name	Parameter Number
STARUP WIZARD	See the section titled Initial Setup on pg. 70 for Startup Wizard Requirements.		
FUNDAMENTAL	Accel/Decel 1 Settings	Automatic Acceleration/Deceleration	F000
		Acceleration Time 1	F009
		Deceleration Time 1	F010
		Acceleration/Deceleration Suspended Function	F349
		Acceleration Suspend Frequency	F350
		Acceleration Suspend Time	F351
		Deceleration Suspend Frequency	F352
		Deceleration Suspend Time	F353
	Frequency Settings	Maximum Frequency	F011
		Upper-Limit Frequency	F012
		Lower-Limit Frequency	F013
		V/f Pattern	F015
		Time Limit for Lower-Limit Frequency Operation	F256
	Motor Set 1	Automatic Torque Boost	F001
		Base Frequency 1	F014
		Manual Torque Boost 1	F016
		Motor Overload Protection Level 1	F600
	Standard Mode Selection	Command Mode	F003
		Frequency Mode 1	F004
		Forward/Reverse Run	F008
		Frequency Priority	F200
		Frequency Mode 2	F207
		Frequency Mode Priority Switching Frequency	F208
TERMINAL	Analog Output Terminals	FM Output Terminal Function	F005
		FM Output Terminal Adjustment	F006

Program Mode Menu Navigation			
Primary Menu	Sub Menu	Parameter Name	Parameter Number
TERMINAL	Analog Output Terminals	FM Output Gradient Characteristic	F682
		FM Bias Adjustment	F683
		FM Voltage/Current Output Switching	F681
		AM Output Terminal Function	F670
		AM Output Terminal Adjustment	F671
		AM Output Gradient Characteristic	F685
		AM Bias Adjustment	F686
		MON 1 Terminal Meter Selection	F672
		MON 1 Terminal Meter Adjustment	F673
		MON 1 Output Gradient Characteristic	F689
		MON 1 Bias Adjustment	F690
		MON 1 Voltage/Current Output Switching	F688
		MON 2 Terminal Meter Selection	F674
		MON 2 Terminal Meter Adjustment	F675
		MON 2 Output Gradient Characteristic	F692
		MON 2 Bias Adjustment	F693
		MON 2 Voltage/Current Output Switching	F691
		Pulse Output Function	F676
		Pulse Output Frequency	F677
		Input Special Functions	Forward/Reverse Run Priority When Both Are Activated
	Input Terminal Priority		F106
	16-Bit Binary/BCD Input		F107
	V/I Analog Input Broken Wire Detection Level		F633
	Input Terminal Delays	Input Terminal 1 (F) Response Time	F140
		Input Terminal 2 (R) Response Time	F141
		Input Terminal 3 (ST) Response Time	F142
		Input Terminal 4 (RES) Response Time	F143
		Input Terminal 5–12 Response Time	F144
		Input Terminal 13–20 Response Time	F145

Program Mode Menu Navigation

Primary Menu	Sub Menu	Parameter Name	Parameter Number
TERMINAL	Input Terminals	Always ON Terminal Function	F110
		Input Terminal 1 (F) Function	F111
		Input Terminal 2 (R) Function	F112
		Input Terminal 3 (ST) Function	F113
		Input Terminal 4 (RES) Function	F114
		Input Terminal 5 (S1) Function	F115
		Input Terminal 6 (S2) Function	F116
		Input Terminal 7 (S3) Function	F117
		Input Terminal 8 (S4) Function	F118
		Input Terminal 9 (LI1) Function	F119
		Input Terminal 10 (LI2) Function	F120
		Input Terminal 11 (LI3) Function	F121
		Input Terminal 12 (LI4) Function	F122
		Input Terminal 13 (LI5) Function	F123
		Input Terminal 14 (LI6) Function	F124
		Input Terminal 15 (LI7) Function	F125
		Input Terminal 16 (LI8) Function	F126
		Input Terminal 17 (B12) Function	F164
		Input Terminal 18 (B13) Function	F165
		Input Terminal 19 (B14) Function	F166
		Input Terminal 20 (B15) Function	F167
		Virtual Input Terminal Selection 1	F973
		Virtual Input Terminal Selection 2	F974
	Virtual Input Terminal Selection 3	F975	
	Virtual Input Terminal Selection 4	F976	
	Line Power Switching	Commercial Power/ASD Switching Output	F354
		Commercial Power/ASD Switching Frequency	F355
ASD Side Switching Delay Time		F356	
Commercial Power-Side Switching Delay Time		F357	
Commercial Power Switching Frequency Hold Time		F358	

Program Mode Menu Navigation			
Primary Menu	Sub Menu	Parameter Name	Parameter Number
TERMINAL	Output Terminals	Output Terminal 1 (OUT1) Function	F130
		Output Terminal 2 (OUT2) Function	F131
		Output Terminal 3 (FL) Function	F132
		Output Terminal 4 (OUT3) Function	F133
		Output Terminal 5 (OUT4) Function	F134
		Output Terminal 6 (R1) Function	F135
		Output Terminal 7 (OUT5) Function	F136
		Output Terminal 8 (OUT6) Function	F137
		Output Terminal 9 (R2) Function	F138
		Output Terminal 10 (R3) Function	F168
	Output Terminal 11 (R4) Function	F169	
	Reach Settings	Low-Speed Signal Output Frequency	F100
		Speed Reach Frequency	F101
Speed Reach Detection Band		F102	
DIRECT ACCESS	Parameter Number Input	N/A	
	Unknown Numbers Accepted		
UTILITIES	Display Parameters	Automatic Function Selection	F040
		Voltage/Current Display Units	F701
		Free Unit Multiplication Factor	F702
		Free Unit	F703
		Free Unit Display Gradient Characteristic	F705
		Free Unit Display Bias	F706
		Change Step Selection 1	F707
		Change Step Selection 2	F708
	Prohibition	Write Parameter Lock Out	F700
		Command Mode/Frequency Mode Lock Out	F736
		Lock Out All Keys	F737
		Local/Remote Key Command Override	N/A
		Local/Remote Key Frequency Override	
	Trace	Trace Selection	F740

Program Mode Menu Navigation			
Primary Menu	Sub Menu	Parameter Name	Parameter Number
UTILITIES	Trace	Trace Cycle	F741
		Trace Data 1	F742
		Trace Data 2	F743
		Trace Data 3	F744
		Trace Data 4	F745
	Alarm Prohibition (prohibits an EOI alarm display ONLY — alarm still activated)	Over-Current Alarm	N/A
		ASD Overload Alarm	
		Motor Overload Alarm	
		Over-Heat Alarm	
		Over-Voltage Alarm	
		Main Power Under-Voltage Alarm	
		Reserved (POFF) Alarm	
		Under-Current Alarm	
		Over-Torque Alarm	
		Braking Resistor Overload Alarm	
		Cumulative Run Timer Alarm	
		DeviceNet/Profibus/CC-Link Alarm	
		RS485 Communication	
		Main Power Under-Voltage Alarm	
		Stop After Instantaneous Power-Off Alarm	
		Stop After Lower-Limit Continuous Time	
		Light-Load Alarm	
		Heavy-Load Alarm	
		Maintenance Timer Alarm	
	Over-Torque Alarm		
	Soft Stall Alarm		
	Type Reset	Reset	F007
	Real-Time Clock Setup	Set Real-Time Clock	N/A
	Trip History (read-only)	Trip Number	N/A
Trip Type			

Program Mode Menu Navigation			
Primary Menu	Sub Menu	Parameter Name	Parameter Number
UTILITIES	Trip History (read-only)	Frequency at Trip	N/A
		Output Current	
		Output Voltage	
		Direction	
		Frequency Reference	
		DC Voltage	
		Discrete Input Terminals	
		Discrete Output Terminals	
		Run Timer	
		Post Compensation Frequency	
		Speed Feedback (Real-Time)	
		Speed Feedback (1 Second)	
		Torque Feedback	
		Torque Reference	
		Torque Current	
		Excitation Current	
		PID Feedback	
		Motor Overload Ratio	
		ASD Overload Ratio	
		DBR Overload Ratio	
		Motor Load	
		ASD Load	
		DBR Load	
	Input Power		
	Output Power		
	Changed From Default	Changed Parameters	N/A
	Contrast	Contrast Adjustment	N/A
Version (read-only)	H9 EOI (Ver:DB)	N/A	
	ASD Type		
	CPU Code Version		

Program Mode Menu Navigation			
Primary Menu	Sub Menu	Parameter Name	Parameter Number
UTILITIES	Version (read-only)	CPU Code Revision	N/A
		MC Version	
		MC Revision	
		Main Board EEPROM Version	
	Main Monitor Selections	Monitor 1	
		Monitor 2	
	View Trace Data	View Trace Data	
PROTECTION	Abnormal Speed Settings	Abnormal Speed Detection Time	F622
		Over-Speed Detection Frequency Upper Band	F623
		Over-Speed Detection Frequency Lower Band	F624
	Base Frequency Voltage	Supply Voltage Correction	F307
	DC Injection Braking	DC Injection Braking Start Frequency	F250
		DC Injection Braking Current	F251
		DC Injection Braking Time	F252
		Forward/Reverse DC Injection Braking Priority	F253
		Motor Shaft Stationary Control	F254
	Dynamic Braking	Dynamic Braking Enable	F304
		Dynamic Braking Resistance	F308
		Continuous Dynamic Braking Capacity	F309
		Braking Resistance Overload Time (10x Rated Torque)	F639
	Emergency Off Settings	Emergency Off	F603
		Emergency DC Injection Braking Control Time	F604
	Low-Current Settings	Low-Current Trip	F610
		Low-Current Detection Current	F611
		Low-Current Detection Time	F612
		Low-Current Detection Hysteresis Width	F609
	Overload	Motor Overload Protection Configuration	F017
		Overload Reduction Start Frequency	F606

Program Mode Menu Navigation			
Primary Menu	Sub Menu	Parameter Name	Parameter Number
PROTECTION	Overload	Motor 150% Overload Time Limit	F607
		ASD Overload	F631
	Over-Torque Parameters	Over-Torque Trip	F615
		Over-Torque Detection Level During Power Running	F616
		Over-Torque Detection Level During Regenerative Braking	F617
		Over-Torque Detection Time	F618
		Over-Torque Detection Hysteresis	F619
	Phase Loss	ASD Output Phase Loss Detection	F605
		ASD Input Phase Loss Detection	F608
	Retry/Restart	Auto Restart Enable	F301
		Number of Times to Retry	F303
		Ridethrough Time	F310
		Random Mode	F312
	Stall	Over-Voltage Limit Operation	F305
		Stall Prevention Factor 1	F416
		Power Running Stall Continuous Trip Detection Time	F452
		Stall Prevention During Regeneration	F453
		Stall Prevention Level	F601
	Trip Settings	Over-Voltage Limit Operation Level	F626
		Retain Trip Record at Power Down	F602
	Under-Voltage/ Ridethrough	Regenerative Power Ridethrough Mode	F302
		Synchronized Deceleration Time	F317
		Synchronized Acceleration Time	F318
		Under-Voltage Trip	F627
		Under-Voltage (Trip Alarm) Detection Time	F628
		Regenerative Power Ridethrough Control Level	F629
	Special Protection Parameters	Short Circuit Detection at Start	F613
		Cooling Fan Control	F620
		Cumulative Operation Time Alarm Setting	F621
		Brake Answer Wait Time	F630

Program Mode Menu Navigation

Primary Menu	Sub Menu	Parameter Name	Parameter Number
FREQUENCY	Analog Filter	Analog Input Filter	F209
	Forward/Reverse Disable	Forward/Reverse Disable	F311
	Jog Settings	Jog Frequency	F260
		Jog Stop Pattern	F261
		EOI Operation Jog Mode	F262
	UP/DOWN Frequency Functions	UP/DOWN Up Response Time	F264
		UP/DOWN Up Frequency Step	F265
		UP/DOWN Down Response Time	F266
		UP/DOWN Down Frequency Step	F267
		Initial UP/DOWN Frequency	F268
		Initial UP/DOWN Frequency Rewriting	F269
	V/I Settings	Option V/I Terminal Voltage/Current Selection (AI2 Option Board Input)	F109
	Preset Speeds	Preset Speed 1	F018
		Preset Speed 2	F019
		Preset Speed 3	F020
		Preset Speed 4	F021
		Preset Speed 5	F022
		Preset Speed 6	F023
		Preset Speed 7	F024
		Preset Speed 8	F287
		Preset Speed 9	F288
		Preset Speed 10	F289
		Preset Speed 11	F290
Preset Speed 12		F291	
Preset Speed 13		F292	
Preset Speed 14		F293	
Preset Speed 15		F294	

Program Mode Menu Navigation

Primary Menu	Sub Menu	Parameter Name	Parameter Number
FREQUENCY	Speed Reference Setpoints	V/I Input Point 1 Setting	F201
		V/I Input Point 1 Frequency	F202
		V/I Input Point 2 Setting	F203
		V/I Input Point 2 Frequency	F204
		RR Input Point 1 Setting	F210
		RR Input Point 1 Frequency	F211
		RR Input Point 2 Setting	F212
		RR Input Point 2 Frequency	F213
		RX Input Point 1 Setting	F216
		RX Input Point 1 Frequency	F217
		RX Input Point 2 Setting	F218
		RX Input Point 2 Frequency	F219
		RX2 Option (AI1) Input Point 1 Setting	F222
		RX2 Option (AI1) Input Point 1 Frequency	F223
		RX2 Option (AI1) Input Point 2 Setting	F224
		RX2 Option (AI1) Input Point 2 Frequency	F225
		BIN Input Point 1 Setting	F228
		BIN Input Point 1 Frequency	F229
		BIN Input Point 2 Setting	F230
		BIN Input Point 2 Frequency	F231
		PG Input Point 1 Setting	F234
		PG Input Point 1 Frequency	F235
		PG Input Point 2 Setting	F236
		PG Input Point 2 Frequency	F237
		V/I Input Bias	F470
		V/I Input Gain	F471
		RR Input Bias	F472
		RR Input Gain	F473
RX Input Bias	F474		
RX Input Gain	F475		

Program Mode Menu Navigation			
Primary Menu	Sub Menu	Parameter Name	Parameter Number
FREQUENCY	Speed Reference Setpoints	RX2 Option (AI1) Input Bias	F476
		RX2 Option (AI1) Input Gain	F477
		V/I Input Bias (AI2 Option Board Input)	F478
		V/I Input Gain (AI2 Option Board Input)	F479
SPECIAL	Acc/Dec 1 – 4 Settings	Acceleration Time 2	F500
		Deceleration Time 2	F501
		Acc/Dec Pattern 1	F502
		Acc/Dec Pattern 2	F503
		Acceleration Time 3	F510
		Deceleration Time 3	F511
		Acc/Dec Pattern 3	F512
		Acceleration Time 4	F514
		Deceleration Time 4	F515
		Acc/Dec Pattern 4	F516
	Acc/Dec Special	Acc/Dec Pattern 1 – 4	F504
		Acc/Dec Switching Frequency 1	F505
		S-Pattern Acceleration Lower-Limit Adjustment	F506
		S-Pattern Acceleration Upper-Limit Adjustment	F507
		S-Pattern Deceleration Lower-Limit Adjustment	F508
		S-Pattern Deceleration Upper-Limit Adjustment	F509
		Acc/Dec Switching Frequency 2	F513
		Acc/Dec Switching Frequency 3	F517
	Carrier Frequency	PWM Carrier Frequency	F300
		Carrier Frequency Control Mode	F316
	Crane/Hoist Settings	Light-Load/High-Speed Operation	F328
		Light-Load/High-Speed Learning Function	F329
		Light-Load/High-Speed Operation Frequency	F330
		Light-Load/High-Speed Operation Switching Lower-Limit Frequency	F331
		Light-Load/High-Speed Operation Load Wait Time	F332
		Light-Load/High-Speed Operation Detection Time	F333

Program Mode Menu Navigation			
Primary Menu	Sub Menu	Parameter Name	Parameter Number
SPECIAL	Crane/Hoist Settings	Light-Load/High-Speed Heavy-Load Detection Time	F334
		Switching Load Torque During Power Running	F335
		Heavy-Load Torque During Power Running	F336
		Heavy-Load Torque During Constant Power Running	F337
		Switching Load Torque During Regeneration Braking	F338
	V/f 5-Point Setting	V/f 5-Point Setting Frequency 1	F190
		V/f 5-Point Setting Voltage 1	F191
		V/f 5-Point Setting Frequency 2	F192
		V/f 5-Point Setting Voltage 2	F193
		V/f 5-Point Setting Frequency 3	F194
		V/f 5-Point Setting Voltage 3	F195
		V/f 5-Point Setting Frequency 4	F196
		V/f 5-Point Setting Voltage 4	F197
		V/f 5-Point Setting Frequency 5	F198
		V/f 5-Point Setting Voltage 5	F199
	Frequency Control	Start Frequency	F240
		Run Frequency	F241
		Run Frequency Hysteresis	F242
		End Frequency	F243
	Special Parameters	0 Hz Dead Band Signal	F244
		0 Hz Command Output	F255
		Exciting Strengthening Coefficient	F415
		Annual Average Ambient Temperature	F634
		Rush Current Suppression Relay Activation Time	F635
		PTC 1 Thermal Selection	F637
		PTC 2 Thermal Selection	F638
	Jump Frequencies	Jump Frequency 1	F270
		Jump Frequency 1 Bandwidth	F271
		Jump Frequency 2	F272
		Jump Frequency 2 Bandwidth	F273

Program Mode Menu Navigation			
Primary Menu	Sub Menu	Parameter Name	Parameter Number
SPECIAL	Jump Frequencies	Jump Frequency 3	F274
		Jump Frequency 3 Bandwidth	F275
	Operation Panel Parameters	Operation Command Clear Selection With Standby Terminal Off	F719
		Panel Stop Pattern	F721
		Panel Torque Command	F725
		Panel Tension Torque Bias	F727
		Panel Load Sharing Gain	F728
		Panel Override Multiplication Gain	F729
		Panel Frequency Lock Out	F730
		Panel Emergency Off Lock Out	F734
		Panel Reset Lock Out	F735
	Traverse	Traverse Selection	F980
		Traverse Acceleration Time	F981
		Traverse Deceleration Time	F982
		Traverse Step	F983
		Traverse Jump Step	F984
	MOTOR	Motor Set 2	Motor Set 2 Base Frequency
Motor Set 2 Base Frequency Voltage			F171
Motor Set 2 Manual Torque Boost			F172
Motor Set 2 Overload Protection Level			F173
Motor Set 3		Motor Set 3 Base Frequency	F174
		Motor Set 3 Base Frequency Voltage	F175
		Motor Set 3 Manual Torque Boost	F176
		Motor Set 3 Overload Protection Level	F177
Motor Set 4		Motor Set 4 Base Frequency	F178
		Motor Set 4 Base Frequency Voltage	F179
		Motor Set 4 Manual Torque Boost	F180
		Motor Set 4 Overload Protection Level	F181
PM Motor		PM Motor Constant 1 (D-Axis Inductance)	F498
		PM Motor Constant 2 (Q-Axis Inductance)	F499

Program Mode Menu Navigation			
Primary Menu	Sub Menu	Parameter Name	Parameter Number
MOTOR	PM Motor	Step-Out Detection-Current Level (For PM Motors)	F640
		Step-Out Detection-Current Time (For PM Motors)	F641
	Vector Motor Model	Autotune 1	F400
		Slip Frequency Gain	F401
		Autotune 2	F402
		Motor Rated Capacity (Nameplate)	F405
		Motor Rated Current (Nameplate)	F406
		Motor Rated RPM (Nameplate)	F407
		Base Frequency Voltage 1	F409
		Motor Constant 1 (Torque Boost)	F410
		Motor Constant 2 (No Load Current)	F411
		Motor Constant 3 (Leak Inductance)	F412
	Motor Constant 4 (Rated Slip)	F413	
TORQUE	Manual Torque Limit Settings	Power Running Torque Limit 2 Level	F444
		Regenerative Braking Torque Limit 2 Level	F445
		Power Running Torque Limit 3 Level	F446
		Regenerative Braking Torque Limit 3 Level	F447
		Power Running Torque Limit 4 Level	F448
		Regenerative Braking Torque Limit 4 Level	F449
	Setpoints	V/I Input Point 1 Rate	F205
		V/I Input Point 2 Rate	F206
		RR Input Point 1 Rate	F214
		RR Input Point 2 Rate	F215
		RX Input Point 1 Rate	F220
		RX Input Point 2 Rate	F221
		RX2 Option (AI1) Input Point 1 Rate	F226
		RX2 Option (AI1) Input Point 2 Rate	F227
	Torque Control	Braking Mode	F341
		Torque Bias Input	F342
		Panel Torque Bias	F343
		Panel Torque Gain	F344

Program Mode Menu Navigation			
Primary Menu	Sub Menu	Parameter Name	Parameter Number
TORQUE	Torque Control	Release Time	F345
		Creeping Frequency	F346
		Creeping Time	F347
		Braking Time Learning Function	F348
		Torque Command	F420
		Tension Torque Bias Input (Torque Control)	F423
		Load Sharing Gain Input	F424
		Forward Speed Limit Input	F425
		Forward Speed Limit Input Level	F426
		Reverse Speed Limit Input	F427
		Reverse Speed Limit Input Level	F428
	Torque Limit Settings	Power Running Torque Limit 1	F440
		Power Running Torque Limit 1 Level	F441
		Regenerative Braking Torque Limit 1	F442
		Regenerative Braking Torque Limit 1 Level	F443
		Acceleration/Deceleration Operation After Torque Limit	F451
	Torque Speed Limiting	Speed Limit (Torque = 0) Center Value Reference	F430
Speed Limit (Torque = 0) Center Value		F431	
Speed Limit (Torque = 0) Band		F432	
Allow Specified Direction ONLY		F435	
FEEDBACK	Drooping Control	Drooping Gain	F320
		Speed at 0% Drooping Gain	F321
		Speed at F320 Drooping Gain	F322
		Drooping Insensitive Torque	F323
		Drooping Output Filter	F324
	Feedback Settings	PID Control Switching	F359
		PID Feedback Signal	F360
		PID Feedback Delay Filter	F361
		PID Feedback Proportional Gain	F362
		PID Feedback Integral Gain	F363

Program Mode Menu Navigation			
Primary Menu	Sub Menu	Parameter Name	Parameter Number
FEEDBACK	Feedback Settings	PID Deviation Upper-Limit	F364
		PID Deviation Lower-Limit	F365
		PID Feedback Differential Gain	F366
		Process Upper-Limit	F367
		Process Lower-Limit	F368
		PID Control Wait Time	F369
		PID Output Upper-Limit	F370
		PID Output Lower-Limit	F371
		Process Increasing Rate	F372
		Process Decreasing Rate	F373
		Speed PI Switching Frequency	F466
	Override Control	Adding Input Selection	F660
		Multiplying Input Selection	F661
	PG Settings	Number of PG Input Pulses	F375
		Number of PG Input Phases	F376
		PG Disconnection Detection	F377
		Simple Positioning Completion Range	F381
		Current Control Proportional Gain	F458
		Speed Loop Proportional Gain	F460
		Speed Loop Stabilization Coefficient	F461
		Load Moment of Inertia 1	F462
		Second Speed Loop Proportional Gain	F463
		Second Speed Loop Stabilization Coefficient	F464
Load Moment of Inertia 2	F465		
MY FUNCTION	My Function Selection	My Function Operating Mode	F977
	My Function Unit 1	Input Function Target 1	F900
		Input Function Command 1	F901
		Input Function Target 2	F902
		Input Function Command 2	F903
		Input Function Target 3	F904
		Output Function Assigned	F905

Program Mode Menu Navigation			
Primary Menu	Sub Menu	Parameter Name	Parameter Number
MY FUNCTION	My Function Unit 2	Input Function Target 1	F906
		Input Function Command 1	F907
		Input Function Target 2	F908
		Input Function Command 2	F909
		Input Function Target 3	F910
		Output Function Assigned	F911
	My Function Unit 3	Input Function Target 1	F912
		Input Function Command 1	F913
		Input Function Target 2	F914
		Input Function Command 2	F915
		Input Function Target 3	F916
		Output Function Assigned	F917
	My Function Unit 4	Input Function Target 1	F935
		Input Function Command 1	F936
		Input Function Target 2	F937
		Input Function Command 2	F938
		Input Function Target 3	F939
		Output Function Assigned	F940
	My Function Unit 5	Input Function Target 1	F941
		Input Function Command 1	F942
		Input Function Target 2	F943
		Input Function Command 2	F944
		Input Function Target 3	F945
		Output Function Assigned	F946
	My Function Unit 6	Input Function Target 1	F947
		Input Function Command 1	F948
		Input Function Target 2	F949
		Input Function Command 2	F950
		Input Function Target 3	F951
		Output Function Assigned	F952

Program Mode Menu Navigation			
Primary Menu	Sub Menu	Parameter Name	Parameter Number
MY FUNCTION	My Function Unit 7	Input Function Target 1	F953
		Input Function Command 1	F954
		Input Function Target 2	F955
		Input Function Command 2	F956
		Input Function Target 3	F957
		Output Function Assigned	F958
	My Function Data	My Function Percent Data 1	F918
		My Function Percent Data 2	F919
		My Function Percent Data 3	F920
		My Function Percent Data 4	F921
		My Function Percent Data 5	F922
		My Function Frequency Data 1	F923
		My Function Frequency Data 2	F924
		My Function Frequency Data 3	F925
		My Function Frequency Data 4	F926
		My Function Frequency Data 5	F927
		My Function Time Data 1	F928
		My Function Time Data 2	F929
		My Function Time Data 3	F930
		My Function Time Data 4	F931
		My Function Time Data 5	F932
		My Function Count Data 1	F933
		My Function Count Data 2	F934
		My Function Analog	Analog Input Function Target 11
	Analog Function Assigned Object 11		F961
	Analog Input Function Target 21		F962
	Analog Function Assigned Object 21		F964
	My Function Monitor	Monitor Output Function 11	F965
		Monitor Output Function Command 11	F966

Program Mode Menu Navigation			
Primary Menu	Sub Menu	Parameter Name	Parameter Number
MY FUNCTION	My Function Monitor	Monitor Output Function 21	F967
		Monitor Output Function Command 21	F968
		Monitor Output Function 31	F969
		Monitor Output Function Command 31	F970
		Monitor Output Function 41	F972
		Monitor Output Function Command 41	F971
COMMUNICATIONS	Communication Adjustments	Frequency Point Selection	F810
		Point 1 Setting	F811
		Point 1 Frequency	F812
		Point 2 Setting	F813
		Point 2 Frequency	F814
	Communication Settings	Baud Rate (2-Wire RS485)	F800
		Parity (2-Wire and 4-Wire RS485)	F801
		ASD Number	F802
		Communications Time-Out (2-Wire and 4-Wire RS485)	F803
		Communication Time-Out Action (2-Wire and 4-Wire RS485)	F804
		Send Wait Time (2-Wire RS485)	F805
		ASD-to-ASD Communication (2-Wire RS485)	F806
		2-Wire RS485 Protocol	F807
		Baud Rate (4-Wire RS485)	F820
		RS485 Send Wait Time	F825
		ASD-to-ASD Communication (4-Wire RS485)	F826
		4-Wire RS485 Protocol (TSB/MODBUS)	F829
		Communication Option (DeviceNet/Profibus) Setting 1	F830
		Communication Option (DeviceNet/Profibus) Setting 2	F831
		Communication Option (DeviceNet/Profibus) Setting 3	F832
Communication Option (DeviceNet/Profibus) Setting 4	F833		
Communication Option (DeviceNet/Profibus) Setting 5	F834		
Communication Option (DeviceNet/Profibus) Setting 6	F835		
Communication Option (DeviceNet/Profibus) Setting 7	F836		

Program Mode Menu Navigation			
Primary Menu	Sub Menu	Parameter Name	Parameter Number
COMMUNICATIONS	Communication Settings	Communication Option (DeviceNet/Profibus) Setting 8	F841
		Communication Option (DeviceNet/Profibus) Setting 9	F842
		Communication Option (DeviceNet/Profibus) Setting 10	F843
		Communication Option (DeviceNet/Profibus) Setting 11	F844
		Communication Option (DeviceNet/Profibus) Setting 12	F845
		Communication Option (DeviceNet/Profibus) Setting 13	F846
		Disconnection Detection Extended Time	F850
		ASD Operation at Disconnection	F851
		Preset Speed Operation	F852
		Communication Option Station Address Monitor	F853
		Communication Option Speed Switch Monitor DeviceNet/CC-Link	F854
		Block Write Data 1	F870
		Block Write Data 2	F871
		Block Read Data 1	F875
		Block Read Data 2	F876
		Block Read Data 3	F877
		Block Read Data 4	F878
		Block Read Data 5	F879
	Free Notes	F880	
	Network Option Reset Setting	F899	
Ethernet Settings	IP	N/A	
	Sub Net		
	Gateway		
	DHCP Mode		
	MAC ID		
PATTERN RUN	Operation Mode	Preset Speed Operation Mode	F560
		Preset Speed 1	F561
		Direction	
		Acc/Dec Group	

Program Mode Menu Navigation			
Primary Menu	Sub Menu	Parameter Name	Parameter Number
PATTERN RUN	Operation Mode	V/f Group	F561
		Torque Limit Group	
		Preset Speed 2	F562
		Direction	
		Acc/Dec Group	
		V/f Group	
		Torque Limit Group	
		Preset Speed 3	F563
		Direction	
		Acc/Dec Group	
		V/f Group	
		Torque Limit Group	
		Preset Speed 4	F564
		Direction	
		Acc/Dec Group	
		V/f Group	
		Torque Limit Group	
		Preset Speed 5	F565
		Direction	
		Acc/Dec Group	
		V/f Group	
		Torque Limit Group	
		Preset Speed 6	F566
		Direction	
		Acc/Dec Group	
		V/f Group	
		Torque Limit Group	
		Preset Speed 7	F567
		Direction	
		Acc/Dec Group	

Program Mode Menu Navigation			
Primary Menu	Sub Menu	Parameter Name	Parameter Number
PATTERN RUN	Operation Mode	V/f Group	F567
		Torque Limit Group	
		Preset Speed 8	F568
		Direction	
		Acc/Dec Group	
		V/f Group	
		Torque Limit Group	F569
		Preset Speed 9	
		Direction	
		Acc/Dec Group	
		V/f Group	F570
		Torque Limit Group	
		Preset Speed 10	
		Direction	
		Acc/Dec Group	F571
		V/f Group	
		Torque Limit Group	
		Preset Speed 11	
		Direction	F572
		Acc/Dec Group	
		V/f Group	
		Torque Limit Group	
		Preset Speed 12	F573
		Direction	
		Acc/Dec Group	
		Preset Speed 13	
		Direction	F573
		Acc/Dec Group	

Program Mode Menu Navigation			
Primary Menu	Sub Menu	Parameter Name	Parameter Number
PATTERN RUN	Operation Mode	V/f Group	F573
		Torque Limit Group	
		Preset Speed 14	F574
		Direction	
		Acc/Dec Group	
		V/f Group	
		Torque Limit Group	F575
		Preset Speed 15	
		Direction	
		Acc/Dec Group	
		V/f Group	F540
		Torque Limit Group	
	Speed 1 Operation Time		
	Speed 2 Operation Time		
	Speed 3 Operation Time		
	Speed 4 Operation Time		
	Speed 5 Operation Time		
	Speed 6 Operation Time		
	Speed 7 Operation Time		
	Speed 8 Operation Time		
	Speed 9 Operation Time		
	Speed 10 Operation Time		
	Speed 11 Operation Time		
	Speed 12 Operation Time		
	Speed 13 Operation Time		
	Speed 14 Operation Time		
	Speed 15 Operation Time		
	Pattern Run	Pattern Operation	F520
		Pattern Operation Mode	F521
		Pattern 1 Repeat	F522

Program Mode Menu Navigation			
Primary Menu	Sub Menu	Parameter Name	Parameter Number
PATTERN RUN	Pattern Run	Pattern 2 Repeat	F531
	Speeds	Pattern Group 1 Selection 1	F523
		Pattern Group 1 Selection 2	F524
		Pattern Group 1 Selection 3	F525
		Pattern Group 1 Selection 4	F526
		Pattern Group 1 Selection 5	F527
		Pattern Group 1 Selection 6	F528
		Pattern Group 1 Selection 7	F529
		Pattern Group 1 Selection 8	F530
		Pattern Group 2 Selection 1	F532
		Pattern Group 2 Selection 2	F533
		Pattern Group 2 Selection 3	F534
		Pattern Group 2 Selection 4	F535
		Pattern Group 2 Selection 5	F536
		Pattern Group 2 Selection 6	F537
		Pattern Group 2 Selection 7	F538
		Pattern Group 2 Selection 8	F539
PASSWORD AND Lock Out	Enter Password		N/A
	Change Password	Enter New Password	N/A
	Lock Outs	Reset From Trip	N/A
		Local/Remote	
		Run/Stop from EOI	
		Frequency Change From EOI	
		Monitor Screen	
Parameter Access			
Parameter Write			

System Operation

Initial Setup

Upon initial system power up, the **Startup Wizard** starts automatically. The **Startup Wizard** assists the user with the initial configuration of the input power settings and the output parameters of the H9 ASD.

The **Startup Wizard** may also be selected and run from the [Program](#) menu after the initial startup, if required.

The **Startup Wizard** queries the user to select one of the following items:

Run Now? ⇒ Continue on to item **1** below.

Run Next Time? ⇒ Go to [Program Mode](#).

Manually Configure? ⇒ Go to **Finish** screen and click **Finish**.

Startup Wizard Parameters

Startup parameter settings may be viewed or changed. Change the parameter setting and click **Next**. Or click **Next** without making any changes to go to the next startup parameter.

See the section titled [Startup Wizard Parameter Requirements on pg. 71](#) for further information on the **Startup Wizard** parameters.

Click **Finish** to close the **Startup Wizard** when finished.

1. The [Voltage and Frequency Rating of the Motor](#) (Must make a selection to continue or click **Finish**).
2. The [Upper-Limit Frequency](#).
3. The [Lower-Limit Frequency](#).
4. The [Automatic Acceleration/Deceleration Setting](#).
5. The [Acceleration Time](#).
6. The [Deceleration Time](#).
7. The [Volts per Hertz Setting](#).
8. The [Motor Current Rating](#).
9. The [Motor RPM](#).
10. The [Command Source](#).
11. The [Frequency Reference Source](#).
12. The [Display Unit](#).
13. [Wizard: Finish](#).

Startup Wizard Parameter Requirements

The **Startup Wizard** queries the user for information on the I/O signal parameters, control, and the EOI display settings of the ASD. The ASD may also be setup by directly accessing each of the startup settings via the **Program** menu or the associated **Direct Access Numbers** (see the section titled **Direct Access Parameter Information on pg. 76**).

Upon initial system power up, the **Startup Wizard** starts automatically. It may also be run from the **Program** menu after startup, if required. The user is queried to either **(1) Run Now**, **(2) Run Next Time**, or **(3) Manually Configure** the ASD.

Select **Run Now** to start the **Startup Wizard**. The wizard will assist the user with the configuration of the **H9 Adjustable Speed Drive** using the user-input screens below starting with the **Voltage and Frequency Rating of the Motor**.

Select **Run Next Time** to return to the **Program** menu. The system will default to the **Startup Wizard** on the next power up.

Select **Manually Configure** to go to the **Finish** box. Click **Finish** to return the system to the **Frequency Command** screen.

Voltage and Frequency Rating of the Motor

Motors are designed and manufactured to be operated within a specific voltage and frequency range. The voltage and frequency specifications for a given motor may be found on the nameplate of the motor. Highlight and click on the voltage and frequency of the motor being used.

Upper-Limit Frequency

This parameter sets the highest frequency that the ASD will accept as a frequency command or frequency setpoint. The ASD may output frequencies higher than the **Upper-Limit Frequency** (but, lower than the **Maximum Frequency**) when operating in the **PID Control** mode, **Torque Control** mode, or the **Vector Control** modes (sensorless or feedback).

Lower-Limit Frequency

This parameter sets the lowest frequency that the ASD will accept as a frequency command or frequency setpoint. The ASD will output frequencies lower than the **Lower-Limit Frequency** when accelerating to the lower-limit or decelerating to a stop. Frequencies below the **Lower-Limit** may be output when operating in the **PID Control** mode, **Torque Control** mode, or the **Vector Control** modes (sensorless or feedback).

Automatic Acceleration/Deceleration

When **Automatic ACC/DEC** is chosen, the ASD adjusts the acceleration and deceleration rates according to the applied load. The minimum accel/decel time may be set using **F508**. The motor and the load must be connected prior to selecting **Automatic Accel/Decel**.

Select **Manual** to allow the settings of **F009** and **F010** to control the accel/decel, respectively. The acceleration and deceleration times range from 12.5% to 800% of the programmed values for the active acceleration time.

Select **Automatic ACC Only** to allow for the acceleration rate to be controlled automatically only.

Acceleration Time

This parameter specifies the time in seconds for the output of the ASD to go from 0.0 Hz to the **Maximum Frequency** for the **1 Acceleration** profile. The **Accel/Decel Pattern** may be set using **F502**.

Deceleration Time

This parameter specifies the time in seconds for the output of the ASD to go from the **Maximum Frequency** to 0.0 Hz for the **1 Deceleration** profile. The **Accel/Decel Pattern** may be set using [F502](#).

Volts per Hertz Setting

This function establishes the relationship between the output frequency and the output voltage of the ASD.

Settings:

Constant Torque

Voltage Decrease Curve

Automatic Torque Boost

Sensorless Vector Control (Speed)

Sensorless Vector Control (Speed/Torque Switching)

V/f 5-point Curve (Go to [F190](#) to configure the V/f 5-Point Settings)

PM Drive (Permanent Magnet)

PG Feedback Vector Control (Speed)

PG Feedback Vector Control (Speed/Torque Switching)

Motor Current Rating

This parameter allows the user to input the full load amperage (FLA) of the motor. This value is found on the nameplate of the motor and is used by the ASD to determine the **Thermal Overload Protection** setting for the motor.

Motor RPM

This parameter is used to input the (nameplated) rated speed of the motor.

Command Source

This selection allows the user to establish the source of the **Run** commands. Run commands are **Run**, **Stop**, **Jog**, etc.

Settings:

Use Terminal Block

Use EOI (Keypad)

Use RS485

Use Communication Option Board

Frequency Reference Source

This selection allows the user to establish the source of the **Frequency** command.

Settings:

- Use V/I
- Use RR
- Use RX
- EOI (Keypad)
- RS485
- Communication Option Board
- RX2 Option (A11)
- Option V/I
- UP/DOWN Frequency
- Pulse Input (Option)
- Pulse Input (Motor CPU)
- Binary/BCD Input (Option)

Display Unit

This parameter sets the unit of measurement for current and voltage values displayed on the EOI.

Wizard: Finish

This is the final screen of the **Startup Wizard**. The basic parameters of the ASD have been set. Click **Finish** to return to the **Program** mode. Additional application-specific programming may be required.

Operation (Local)

Note: See the section titled *EOI Features on pg. 30* for information on **Remote** operation.

To turn the motor on perform the following:

1. Connect the **CC** terminal to the **ST** terminal.
2. Press the **Mode** key until the **Frequency Command** screen is displayed.
3. Press the **Local/Remote** key to enter the **Local** mode (green **Local** LED illuminates).
4. Turn the **Rotary Encoder** clockwise until the desired **Frequency Command** value is displayed in the **SET** field of the LCD screen.
5. Press the **Run** key and the motor runs at the **Frequency Command** value.

Frequency Command Screen

0 ——— ——— ——— ——— 100%		
SET:	0.00 Hz	
DC Voltage:	0.00%	
Output Current:	0.00%	
F R ST RES S1 S2 S3 S4		
OUT1 OUT2 FL		

Note: The speed of the motor may be changed while the motor is running by using the **Rotary Encoder** to change the **Frequency Command** value.

6. Press the **Stop-Reset** key to stop the motor.

Default Setting Changes

To change a default parameter setting go to the root level of the **Program** menu. Turn the **Rotary Encoder** until the desired parameter group is within the cursor block. Press the **Rotary Encoder** to select an item or to access a subgroup (repeat if required until reaching the parameter to be changed).

Press the **Rotary Encoder** to enter the **Edit** mode and the value/setting takes on the reverse video format (dark background/light text). Turn the **Rotary Encoder** to change the parameter value/setting.

Press **ESC** key while the new parameter setting is still in the reverse video mode to exit the menu without saving the change or press the **Rotary Encoder** while the parameter setting is in the reverse video mode to accept the new setting.

For a complete listing of the **Program** mode menu selections, see the section titled **Program Mode Menu Navigation on pg. 46**. **Program** menu items are listed and mapped for convenience. The **Direct Access Numbers** are listed where applicable.

The default settings may also be changed by entering the **Parameter Number** of the setting to be changed at the **Direct Access** menu (Program ⇒ Direct Access ⇒ *Applicable Parameter Number*). A listing of the **Direct Access Numbers** and a description of the associated parameter may be found in the section titled **Direct Access Parameter Information on pg. 76**.

A listing of all parameters that have been changed from the default setting may be viewed sequentially by accessing the **Changed From Default** screen (Program ⇒ Utilities ⇒ **Changed From Default**).

The **Changed From Default** feature allows the user to quickly access the parameters that are different from the factory default settings or the post-Reset settings. Once the **Changed From Default** screen is displayed, the system scrolls through all of the system parameters automatically and halts once reaching a changed parameter.

Once stopped at a changed parameter, the **Rotary Encoder** may be clicked once clockwise to continue scrolling forward or clicked once counterclockwise to begin scrolling in reverse. With each click of the **Rotary Encoder** from a stop, the system scrolls through the parameters and stops at the next parameter that has been changed.

Press the **Rotary Encoder** while stopped at a changed parameter to display the settings of the changed parameter. Press the **Rotary Encoder** to enter the **Edit** mode — the parameter value/setting takes on the reverse video format (dark background/light text). Turn the **Rotary Encoder** to change the parameter setting.

Press the **ESC** key while the setting is in the reverse video format to exit the **Edit** mode without saving the change and to resume the **Changed From Default** search. Or press the **Rotary Encoder** while the setting is in the reverse video format to save the change. Press **ESC** to return to the **Changed From Default** search.

Pressing **ESC** while the system is performing a **Changed From Default** search terminates the search. Pressing **ESC** when finished searching (or halted at a changed parameter) takes the menu back one level.

Note: *Communications setting changes will require that the power be removed and then re-applied for the changes to take affect.*

Note: *Parameter F201 was changed to create the example shown in Figure 28.*

Figure 28. Changed From Default Screen.

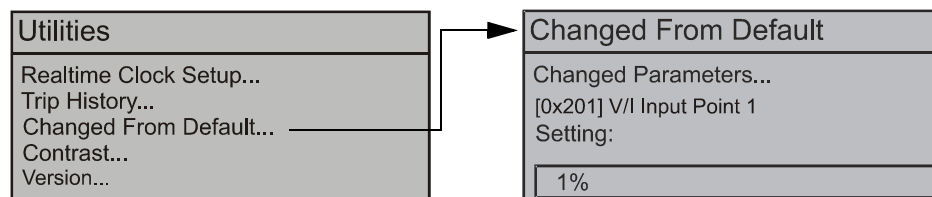

Save User Settings

A profile of an existing setup may be saved and re-applied when required by using the **Save User Setup** feature. This function is carried out via Program ⇒ Utilities ⇒ Type Reset ⇒ **Save User Settings**.

With the initial setup saved, troubleshooting and diagnostics may be performed and the starting setup may be re-applied when finished via Program ⇒ Utilities ⇒ Type Reset ⇒ **Restore User Settings**.

Note: *EOI settings are not stored or restored using the **Save User Settings** or **Restore User Settings**, respectively (i.e., contrast setting, voltage/current units, display gradient characteristics, etc.). See the section titled [Battery Backup on pg. 28](#) for more information on stored EOI settings.*

Direct Access Parameter Information

The H9 ASD has the ability to allow the user direct access to the motor control functions. There are two ways in which the motor control parameters may be accessed for modification: Program ⇒ **Applicable Menu Path** or Program ⇒ Direct Access ⇒ **Applicable Parameter Number**. Both methods access the parameter via the **Program** mode. Once accessed, the parameter may be viewed or changed.

The **Program** mode allows the user to develop an application-specific motor control profile. Motor control functions may be set to accommodate specific power and timing requirements for a given application. The configurable parameters of the **Program** mode that have user-accessible **Parameter Numbers** are listed and described below.

Note: *Parameter selections are preceded by the number used to select an item if using communications to write to a parameter location in memory (i.e., F000 ⇒ 0-Manual, 1- No Trip on Acc/Dec, 2-No trip on Acc Only, etc.).*

Note: *The setup procedures included within this section may require a **Reset** before performing the procedure. Application-specific settings may then be performed. The pre-Reset conditions may be saved (see F007).*

Note: *Communications setting changes will require that the power be removed and then re-applied for the changes to take affect.*

Direct Access Parameters/Numbers

Automatic Acceleration/Deceleration

Program ⇒ Fundamental ⇒ Accel/Decel 1 Settings

This parameter is used to enable acceleration and deceleration rates in accordance with the applied load automatically.

The adjusted acceleration and deceleration times range from 12.5% to 800% of the programmed values for **Acceleration Time 1 (F009)** and **Deceleration Time 1 (F010)**.

Settings:

- 0 — Manual
- 1 — Automatic ACC/DEC
- 2 — Automatic ACC Only

Note: *The motor and the load must be connected prior to selecting **Automatic Acceleration/Deceleration**.*

Direct Access Number — F000

Parameter Type — **Selection List**

Factory Default — **Manual**

Changeable During Run — **No**

Automatic Torque Boost

Program ⇒ Fundamental ⇒ Motor Set 1

This parameter allows the ASD to adjust the output torque in accordance with the applied load automatically. When enabled Autotuning is performed — the motor should be connected before performing an Autotune.

Settings:

- 0 — Disabled
- 1 — Automatic Torque Boost + Autotuning
- 2 — Sensorless Vector Control + Autotuning

Direct Access Number — F001

Parameter Type — **Selection List**

Factory Default — **Disabled**

Changeable During Run — **No**

Command Mode Selection

Program ⇒ Fundamental ⇒ Standard Mode Selection

The **Command Mode Selection** establishes the source of the command input for the ASD. Command inputs include **Run**, **Stop**, **Forward**, etc. The **Override** feature may supersede the **Command Mode Selection** setting (see [Command Mode and Frequency Mode Control](#) on pg. 36).

Settings:

- 0 — Terminal Block
- 1 — Not Used
- 2 — EOI (Keypad)
- 3 — RS485
- 4 — Communication Option Board

Direct Access Number — F003

Parameter Type — Selection List

Factory Default — Terminal Block

Changeable During Run — No

Frequency Mode 1

Program ⇒ Fundamental ⇒ Standard Mode Selection

The **Frequency Mode 1** setting establishes the source of the frequency-control input for the ASD. The **Frequency Mode 2** setting or the **Override** feature may supersede the **Frequency Mode 1** setting.

***Note:** Only **Bolded** items from the **Settings** list below may be placed in the **Override Mode**. See the section titled [Command Mode and Frequency Mode Control](#) on pg. 36 for more information on the **Override** feature.*

Settings:

- 1 — **V/I**
- 2 — RR
- 3 — RX
- 5 — **EOI** (Keypad)
- 6 — **RS485**
- 7 — Communication Option Board
- 8 — RX2 Option (A11)
- 9 — **Option V/I**
- 10 — UP/DOWN Frequency
- 11 — Pulse Input (Option)
- 12 — Pulse Input (Motor CPU)
- 13 — Binary/BCD Input (Option)

Direct Access Number — F004

Parameter Type — Selection List

Factory Default — RR

Changeable During Run — No

FM Output Terminal Function

Program ⇒ Terminal ⇒ Analog Output Terminals

This parameter is used to set the output function of the **FM** analog output terminal. The **FM** output terminal produces an output current or voltage that is proportional to the magnitude of the function assigned to this terminal (select current or voltage at [F681](#)). The available assignments for this output terminal are listed in [Table 6 on pg. 237](#).

***Note:** To read **voltage** at this terminal connect a 100 – 500Ω resistor from the **FM** (+) terminal to the **CC** (-) terminal. Using a voltmeter read the voltage across the 100 – 500Ω resistor.*

*To read **current** at this terminal connect a 100 – 500Ω resistor from the **FM** (+) terminal through a series Ammeter to the **CC** (-) terminal.*

*The **FM** analog output has a maximum resolution of 1/1024 and a maximum load rating of 500 ohms.*

FM Terminal Setup Parameters

- [F005](#) — Set FM Function
- [F006](#) — Calibrate FM Terminal
- [F681](#) — Voltage/Current Output Switching Selection
- [F682](#) — Output Response Polarity Selection
- [F683](#) — Set Zero Level

FM Output Terminal Adjustment

Program ⇒ Terminal ⇒ Analog Output Terminals

This parameter is used to calibrate the **FM** analog output.

To calibrate the **FM** analog output, connect a meter (current or voltage) as described at [F005](#).

With the drive running at a known value (e.g., output frequency), adjust this parameter until the assigned function produces the desired DC level output at the **FM** output terminal.

See [F005](#) for more information on this setting.

Direct Access Number — **F005**

Parameter Type — **Selection List**

Factory Default — **Output Frequency**

Changeable During Run — **Yes**

Direct Access Number — **F006**

Parameter Type — **Numerical**

Factory Default — **493**

Changeable During Run — **Yes**

Minimum — 1

Maximum — 1280

Type Reset

Program ⇒ Utilities

This feature assists the user when performing fault analysis or by allowing a quick system setup change when required. Performing a **Type Reset** results in one of the following user-selected post-Reset configurations.

Settings:

- 0 — None
- 1 — 50 Hz Setting
- 2 — 60 Hz Setting
- 3 — Reset to Factory Settings
- 4 — Clear Past Trips
- 5 — Clear Run Timer
- 6 — Initialize Typeform
- 7 — *Save User Settings
- 8 — Restore User Settings
- 9 — Clear Cumulative Fan Timer
- 10 — Accel/Decel Time Setting 0.01 – 600.0 Seconds
- 11 — Accel/Decel Time Setting 0.1 – 6000.0 Seconds
- 12 — Update EOI Firmware
- 13 — Set EOI Memory to Default
- 14 — Save User Settings to EOI
- 15 — Restore User Settings from EOI

Note: User settings that are stored in the memory of the EOI are not saved via the **Save User Settings** selection. The unsaved functions include the **EOI Option Setups**, (Utilities ⇒) **Display Parameters**, and (Monitor Setup ⇒) **Scrolling Monitor Select**.

Direct Access Number — F007Parameter Type — **Selection List**Factory Default — **None**Changeable During Run — **No**

Forward/Reverse Run Selection

Program ⇒ Fundamental ⇒ Standard Mode Selection

While operating in the **Local** mode, this parameter sets the direction of motor rotation.

From the **Frequency Command** screen press the **ESC** key. At the subsequent **EOI Command** screen select the **Direction** field and change the setting. Press the **Rotary Encoder** and the new setting will be in effect.

This setting will not override parameter **F311** (Forward/Reverse Disable).

If either direction is disabled via parameter **F311**, the disabled direction will not be recognized if commanded by the EOI. If both directions are disabled via parameter **F311**, the direction command from the EOI will determine the direction of the motor rotation.

Settings:

- 0 — Forward
- 1 — Reverse
- 2 — Forward (EOI-Switchable F/R)
- 3 — Reverse (EOI-Switchable F/R)

Direct Access Number — F008Parameter Type — **Selection List**Factory Default — **Forward**Changeable During Run — **Yes**

Acceleration Time 1

Program ⇒ Fundamental ⇒ Accel/Decel 1 Settings

This parameter specifies the time in seconds for the output of the ASD to go from 0.0 Hz to the **Maximum Frequency** for the **1 Acceleration** profile. The Accel/Decel pattern may be set using [F502](#). The minimum Accel/Decel time may be set using [F508](#).

Note: *An acceleration time shorter than that which the load will allow may cause nuisance tripping and mechanical stress to loads. **Automatic Accel/Decel, Stall, and Ridethrough** settings may lengthen the acceleration times.*

Acceleration

The acceleration rate of a motor is determined by several factors: applied power, applied load, and the physical properties of the motor (winding parameters, motor size, etc.). The ASD will control the first of these factors: input power. The settings of the ASD will control the frequency and amplitude of the applied voltage to the motor.

Under most operating conditions, as the output frequency of the drive goes up so does the output voltage (linear acceleration). The ASD has the ability to modify the relationship between frequency and voltage automatically to produce smoother operation or increased (starting) torque (see [F502](#)).

Deceleration Time 1

Program ⇒ Fundamental ⇒ Accel/Decel 1 Settings

This parameter specifies the time in seconds for the output of the ASD to go from the **Maximum Frequency** to 0.0 Hz for the **1 Deceleration** profile. The Accel/Decel pattern may be set using [F502](#).

When operating with the **Automatic Accel/Decel** enabled ([F000](#)) the minimum accel/decel time may be set using [F508](#).

Note: *A deceleration time shorter than the load will allow may cause nuisance tripping and mechanical stress to loads. **Automatic Accel/Decel, Stall, and Ridethrough** settings may lengthen the deceleration times.*

Maximum Frequency

Program ⇒ Fundamental ⇒ Frequency Settings

This setting determines the absolute maximum frequency that the ASD can output.

Accel/Decel times are calculated based on the **Maximum Frequency** setting.

The **Maximum Frequency** is not limited by this setting while operating in the **Drooping Control** mode (see [F320](#) for more information on this setting).

Note: *This setting may not be lower than the **Upper-Limit Frequency (F012)** setting.*

Direct Access Number — F009Parameter Type — **Numerical**Factory Default — **(ASD-Dependent)**Changeable During Run — **Yes**

Minimum — 0.1

Maximum — 6000

Units — Seconds

Direct Access Number — F010Parameter Type — **Numerical**Factory Default — **(ASD-Dependent)**Changeable During Run — **Yes**

Minimum — 0.1

Maximum — 6000

Units — Seconds

Direct Access Number — F011Parameter Type — **Numerical**Factory Default — **80.0**Changeable During Run — **No**

Minimum — 30.0

Maximum — 299.0

Units — Hz

Upper-Limit Frequency

Program ⇒ Fundamental ⇒ Frequency Settings

This parameter sets the highest frequency that the ASD will accept as a frequency command or frequency setpoint. The ASD may output frequencies higher than the **Upper-Limit Frequency** (but, lower than the **Maximum Frequency**) when operating in the **PID Control** mode, **Torque Control** mode, or the **Vector Control** modes (sensorless or feedback).

Note: This setting may not be higher than the **Maximum Frequency (F011)** setting.

Direct Access Number — F012

Parameter Type — **Numerical**

Factory Default — **(ASD-Dependent)**

Changeable During Run — **Yes**

Minimum — 0.0

Maximum — **Max. Freq. (F011)**

Units — Hz

Lower-Limit Frequency

Program ⇒ Fundamental ⇒ Frequency Settings

This parameter sets the lowest frequency that the ASD will accept as a frequency command or frequency setpoint. The ASD will output frequencies lower than the **Lower-Limit Frequency** when accelerating to the lower-limit or decelerating to a stop. Frequencies below the **Lower-Limit** may also be output when operating in the **PID Control** mode, **Torque Control** mode, or the **Vector Control** modes (sensorless or feedback).

Direct Access Number — F013

Parameter Type — **Numerical**

Factory Default — **0.00**

Changeable During Run — **Yes**

Minimum — 0.00

Maximum — **Upper-Limit (F012)**

Units — Hz

Base Frequency 1

Program ⇒ Fundamental ⇒ Motor Set 1

The **Base Frequency 1** setting is the frequency at which the output voltage of the ASD reaches its maximum setting. The **Base Frequency Voltage 1** parameter is set at [F409](#).

For proper motor operation, the **Base Frequency** should be set for the nameplated frequency of the motor.

Direct Access Number — F014

Parameter Type — **Numerical**

Factory Default — **60.0**

Changeable During Run — **Yes**

Minimum — 0.0

Maximum — **Upper-Limit (F012)**

Units — Hz

V/f Pattern

Program ⇒ Fundamental ⇒ Frequency Settings

This function establishes the relationship between the output frequency and the output voltage.

Bolded selections use the motor tuning parameters of the drive to properly configure the ASD for the motor being used. If **Load Reactors** or **Long Lead Filters** are used, or if the capacity of the ASD is greater than the motor, manual tuning of the motor parameters may be required for optimum performance.

Settings:

- 0 — Constant Torque
- 1 — Voltage Decrease Curve
- 2 — **Automatic Torque Boost**
- 3 — **Sensorless Vector Control (Speed)**
- 4 — **Sensorless Vector Control (Speed/Torque Switching)**
- 5 — V/f 5-point Curve (Go to [F190](#) to configure the V/f 5-Point Settings)
- 6 — PM Drive (Permanent Magnet)
- 7 — **PG Feedback Vector Control (Speed)**
- 8 — **PG Feedback Vector Control (Speed/Torque Switching)**

Note: When operating in the **Vector Control** mode the carrier frequency should be set to 2.2 kHz or above.

Direct Access Number — F015

Parameter Type — **Selection List**

Factory Default — **Constant Torque**

Changeable During Run — **No**

Manual Torque Boost 1

Program ⇒ Fundamental ⇒ Motor Set 1

The **Manual Torque Boost 1** function is used to increase the low frequency torque for high-inertia loads by increasing the output voltage at frequencies below ½ of the **Base Frequency 1 (F014)** setting.

The value programmed as a boost percentage establishes an output voltage vs. output frequency relationship to be used to start the motor or to provide smoother operation.

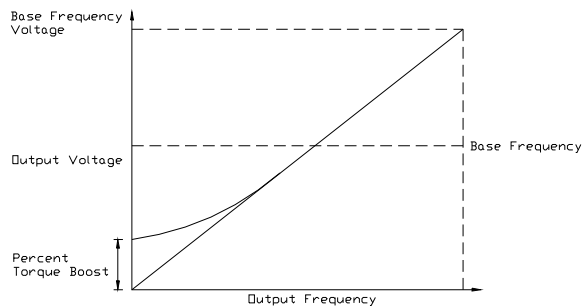

Note: Setting an excessive **Torque Boost** level may cause nuisance tripping and mechanical stress to loads.

Direct Access Number — F016

Parameter Type — Numerical

Factory Default — (ASD-Dependent)

Changeable During Run — Yes

Minimum — 0.0

Maximum — 30.0

Units — %

Motor Overload Protection Configuration

Program ⇒ Protection ⇒ Overload

This parameter is used to protect the motor from an over-current condition. The type of motor being used and the **Overload Stall** setting is selected here to better match the application.

This parameter setting may extend the **Over-Voltage Stall** time settings.

This parameter may be affected by the setting of the **Power Running Stall Continuous Trip Detection Time (F452)**.

Settings:

- 0 — Overload Trip without Stall
- 1 — Overload Trip with Stall
- 2 — No Overload without Stall
- 3 — Stall Only
- 4 — V/f Motor-Overload without Stall
- 5 — V/f Motor-Overload with Stall
- 6 — V/f Motor-No Overload without Stall
- 7 — V/f Motor-Stall Only

Direct Access Number — F017

Parameter Type — Selection List

Factory Default — O/L Trip No Stall

Changeable During Run — Yes

Preset Speed 1

Program ⇒ Frequency ⇒ Preset Speeds

Up to fifteen (15) output frequency values that fall within the **Lower-Limit** and the **Upper-Limit** range may be programmed into the drive and output as a **Preset Speed**. This parameter assigns an output frequency to binary number 0001 and is identified as **Preset Speed 1**. The binary number is applied to **S1 – S4** of the **Terminal Board** to output the **Preset Speed**.

Perform the following setup to allow the system to receive **Preset Speed** control input at the **S1 – S4** terminals:

1. Program ⇒ Fundamental ⇒ Standard Mode Selection ⇒ Command Mode Selection ⇒ **Terminal Block**.
2. Program ⇒ Terminal ⇒ Input Terminals ⇒ **S1** (set to **Preset Speed 1**; LSB of 4-bit count). Repeat for **S2 – S4** (MSB of 4-bit count) as **Preset Speed 2 – 4**, respectively (all **Normally Open**).
3. Program ⇒ Frequency ⇒ Preset Speeds ⇒ **Preset Speed 1** (set an output frequency as **Preset Speed 1**; repeat for **Preset Speeds 2 – 15** as required).
4. Program ⇒ Pattern Run ⇒ Operation Mode ⇒ Preset Speed Operation Mode ⇒ **Enabled/Disabled**.

Select **Enabled** to use the direction, accel/decel, and torque settings of the **Preset Speed** being run. The torque settings used will be as defined in **F170 – F181** and as selected via the associated discrete input terminals **V/f Switching 1** and **2** in **Table 5** on **pg. 234**.

Select **Disabled** to use the speed setting only of the **Preset Speed** being run.

5. Place the system in the **Remote** mode (Local/Remote LED Off).
6. Provide a **Run** command (connect **F** and/or **R** to **CC**).

Connect **S1** to **CC** to run **Preset Speed 1** (**S1** to **CC** = 0001 binary).

With **S1 – S4** configured to output **Preset Speeds** (**F115 – F118**), 0001 – 1111 may be applied to **S1 – S4** of the **Terminal Board** to run the associated **Preset Speed**. If bidirectional operation is required, **F** and **R** must be connected to **CC**, and **Preset Speed Operation Mode** must be set to **Enabled** at **F560**.

With **S1** being the least significant bit of a binary count, the **S1 – S4** settings will produce the programmed speed settings as indicated in the **Preset Speed Truth Table** to the right.

Preset Speeds are also used in the **Pattern Run** mode.

Direct Access Number — F018

Parameter Type — **Numerical**

Factory Default — **0.0**

Changeable During Run — **Yes**

Minimum — **Lower-Limit (F013)**

Maximum — **Upper-Limit (F012)**

Units — Hz

Preset Speed Truth Table

Preset	S4 MSB	S3	S2	S1 LSB	Output
1	0	0	0	1	F018
2	0	0	1	0	F019
3	0	0	1	1	F020
4	0	1	0	0	F021
5	0	1	0	1	F022
6	0	1	1	0	F023
7	0	1	1	1	F024
8	1	0	0	0	F287
9	1	0	0	1	F288
10	1	0	1	0	F289
11	1	0	1	1	F290
12	1	1	0	0	F291
13	1	1	0	1	F292
14	1	1	1	0	F293
15	1	1	1	1	F294

Note: 1 = Terminal connected to CC.

Preset Speed 2

Program ⇒ Frequency ⇒ Preset Speeds

This parameter assigns an output frequency to binary number 0010 and is identified as **Preset Speed 2**. The binary number is applied to **S1 – S4** of the **Terminal Board** to output the **Preset Speed** (see **F018** for more information on this parameter).

Direct Access Number — F019

Parameter Type — **Numerical**

Factory Default — **0.0**

Changeable During Run — **Yes**

Minimum — **Lower-Limit (F013)**

Maximum — **Upper-Limit (F012)**

Units — Hz

<p>Preset Speed 3</p> <p>Program ⇒ Frequency ⇒ Preset Speeds</p> <p>This parameter assigns an output frequency to binary number 0011 and is identified as Preset Speed 3. The binary number is applied to S1 – S4 of the Terminal Board to output the Preset Speed (see F018 for more information on this parameter).</p>	<p>Direct Access Number — F020</p> <p>Parameter Type — Numerical</p> <p>Factory Default — 0.0</p> <p>Changeable During Run — Yes</p> <p>Minimum — Lower-Limit (F013)</p> <p>Maximum — Upper-Limit (F012)</p> <p>Units — Hz</p>
<p>Preset Speed 4</p> <p>Program ⇒ Frequency ⇒ Preset Speeds</p> <p>This parameter assigns an output frequency to binary number 0100 and is identified as Preset Speed 4. The binary number is applied to S1 – S4 of the Terminal Board to output the Preset Speed (see F018 for more information on this parameter).</p>	<p>Direct Access Number — F021</p> <p>Parameter Type — Numerical</p> <p>Factory Default — 0.0</p> <p>Changeable During Run — Yes</p> <p>Minimum — Lower-Limit (F013)</p> <p>Maximum — Upper-Limit (F012)</p> <p>Units — Hz</p>
<p>Preset Speed 5</p> <p>Program ⇒ Frequency ⇒ Preset Speeds</p> <p>This parameter assigns an output frequency to binary number 0101 and is identified as Preset Speed 5. The binary number is applied to S1 – S4 of the Terminal Board to output the Preset Speed (see F018 for more information on this parameter).</p>	<p>Direct Access Number — F022</p> <p>Parameter Type — Numerical</p> <p>Factory Default — 0.0</p> <p>Changeable During Run — Yes</p> <p>Minimum — Lower-Limit (F013)</p> <p>Maximum — Upper-Limit (F012)</p> <p>Units — Hz</p>
<p>Preset Speed 6</p> <p>Program ⇒ Frequency ⇒ Preset Speeds</p> <p>This parameter assigns an output frequency to binary number 0110 and is identified as Preset Speed 6. The binary number is applied to S1 – S4 of the Terminal Board to output the Preset Speed (see F018 for more information on this parameter).</p>	<p>Direct Access Number — F023</p> <p>Parameter Type — Numerical</p> <p>Factory Default — 0.0</p> <p>Changeable During Run — Yes</p> <p>Minimum — Lower-Limit (F013)</p> <p>Maximum — Upper-Limit (F012)</p> <p>Units — Hz</p>
<p>Preset Speed 7</p> <p>Program ⇒ Frequency ⇒ Preset Speeds</p> <p>This parameter assigns an output frequency to binary number 0111 and is identified as Preset Speed 7. The binary number is applied to S1 – S4 of the Terminal Board to output the Preset Speed (see F018 for more information on this parameter).</p>	<p>Direct Access Number — F024</p> <p>Parameter Type — Numerical</p> <p>Factory Default — 0.0</p> <p>Changeable During Run — Yes</p> <p>Minimum — Lower-Limit (F013)</p> <p>Maximum — Upper-Limit (F012)</p> <p>Units — Hz</p>

Automatic Function Selection

Program ⇒ Utilities ⇒ Display Parameters

This parameter setting is used to configure multiple parameters with the setting of only one parameter. From the selection below multiple parameters may be set as indicated in the table.

Once set, the selected configuration is placed in effect and remains in effect until this parameter is changed or the individual settings are changed.

Set this parameter to **Disable** to set these parameters individually.

*Note: After performing the desired selection the EOI display returns to **Disabled** though the selected function has been carried out (i.e., without this, if selection 1 is performed, **F004** and **F207** would hold the **RR** terminal setting regardless of attempts to change the settings individually).*

Settings:

- 0 — Disabled
- 1 — RR
- 2 — V/I
- 3 — RR or V/II (V/I) Switched via Terminal Board
- 4 — EOI Frequency/Terminal Board Command
- 5 — EOI = Frequency and Command

Direct Access Number — F040

Parameter Type — Selection List

Factory Default — Disabled

Changeable During Run — No

Related Parameters	Default Settings	User Settings					5-EOI Freq/ CMD
		0-Disable	1-RR	2-V/I	3-RR or V/I via TB	4-EOI/Freq. CMD/TB	
Command Mode F003	Terminal Board	N/C				Terminal Board	EOI
Frequency Mode 1 F004	RR	N/C	RR	N/C	RR	EOI	
S3 Terminal F117	Preset Speed 3	N/C			Freq. Ref. Priority	N/C	
Frequency Priority F200	Terminal Board	N/C	Terminal Board				
V/I Setup F201	0.0%	N/C		20.0%		N/C	
Frequency Mode 2 F207	V/I	N/C	RR	V/I		EOI	

N/C = No Change — the setting remains as it was before setting parameter F040.

Low-Speed Signal Output Frequency

Program ⇒ Terminal ⇒ Reach Settings

The **Low-Speed Signal Output Frequency** parameter sets a frequency threshold that activates the assigned output terminal for the duration that the ASD output is equal to or above this setting (see [Table 8 on pg. 239](#) for the available output assignments).

Direct Access Number — F100

Parameter Type — **Numerical**

Factory Default — **0.00**

Changeable During Run — **Yes**

Minimum — 0.00

Maximum — **Max. Freq. (F011)**

Units — Hz

Speed Reach Frequency

Program ⇒ Terminal ⇒ Reach Settings

The **Speed Reach Frequency** sets a frequency threshold that, when reached or is within the bandwidth specified by parameter [F102](#), activates the assigned output terminal for the duration that the ASD output is within the bandwidth specified (see [Table 8 on pg. 239](#) for the available output assignments).

Direct Access Number — F101

Parameter Type — **Numerical**

Factory Default — **0.00**

Changeable During Run — **Yes**

Minimum — 0.00

Maximum — **Max. Freq. (F011)**

Units — Hz

Speed Reach Detection Band

Program ⇒ Terminal ⇒ Reach Settings

This parameter sets the bandwidth of the **Speed Reach Frequency (F101)** setting.

Direct Access Number — F102

Parameter Type — **Numerical**

Factory Default — **2.50**

Changeable During Run — **Yes**

Minimum — 0.00

Maximum — **Max. Freq. (F011)**

Units — Hz

Forward/Reverse Run Priority Selection

Program ⇒ Terminal ⇒ Input Special Functions

The **Forward/Reverse Priority Selection** determines the operation of the ASD if the **F** and **R** control terminals are activated simultaneously.

Settings:

0 — Reverse

1 — Suspend

The waveforms shown depict the motor response for all combinations of the **F** and **R** terminal settings if the **Reverse** option is chosen.

The **Suspend** setting will decelerate the motor to a stop regardless of the rotation direction when both the **F** and **R** control terminals are activated.

Direct Access Number — F105

Parameter Type — **Selection List**

Factory Default — **Suspend**

Changeable During Run — **No**

Simultaneous F and R activation.

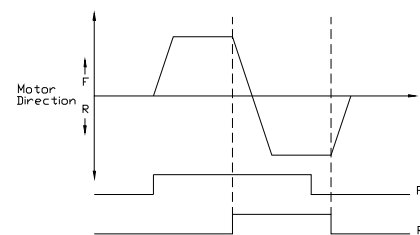

Input Terminal Priority

Program ⇒ Terminal ⇒ Input Special Functions

This parameter is used to allow the **Jog** and **DC Injection Braking** input signals to control the ASD when received via the **Terminal Board** even though the system is in the **Local** mode.

With this parameter enabled, a **Jog** command or a **DC Injection Braking** command received from the **Terminal Board** will receive priority over commands from the **EOI**.

See [F260](#) for more information on using the **Jog** function.

See [F250 – F252](#) for more information on **DC Injection Braking**.

Settings:

- 0 — Disabled
- 1 — Enabled

Direct Access Number — F106Parameter Type — **Selection List**Factory Default — **Disabled**Changeable During Run — **No**

16-Bit Binary/BCD Input

Program ⇒ Terminal ⇒ Input Special Functions

The extended terminal function is used with the **Expansion IO Card Option** (P/N ETB004Z).

This parameter defines the format of the binary or BCD data when using the option card.

***Note:** The **Expansion IO Card Option 2** option board is required to use this terminal.*

See the **Expansion IO Card Option 1** instruction manual (P/N 58685) for more information on the function of this terminal.

Settings:

- 0 — None
- 1 — 12-Bit Binary
- 2 — 16-Bit Binary
- 3 — 3-Digit BCD
- 4 — 4-Digit BCD
- 5 — Inverted 12-Bit Binary
- 6 — Inverted 16-Bit Binary
- 7 — Inverted 3-Digit BCD
- 8 — Inverted 4-Digit BCD

Selections using 16-bit binary or 4-digit BCD will require the configuration of terminals S1-S4 on the **Terminal Board** as binary bits 0 – 3 ([F115 – F118](#)). The **Frequency Mode 1** ([F004](#)) parameter must be set to **Binary/BCD**.

For proper scaling of the binary or BCD input, parameters [F228 – F231](#) must be configured.

Direct Access Number — F107Parameter Type — **Selection List**Factory Default — **None**Changeable During Run — **No**

<p>Option V/I Terminal Voltage/Current Selection</p> <p>Program ⇒ Frequency ⇒ V/I Settings</p> <p>This parameter is used to set the AI2 input terminal to receive either current or voltage as a control signal.</p> <p><i>Note:</i> The Expansion IO Card Option 2 option board (P/N ETB004Z) is required to use this terminal.</p> <p>See the Expansion IO Card Option 2 instruction manual (P/N 58686) for more information on the function of this terminal.</p> <p>Settings:</p> <ul style="list-style-type: none"> 0 — Voltage Input 1 — Current Input 	<p>Direct Access Number — F109</p> <p>Parameter Type — Selection List</p> <p>Factory Default — Voltage Input</p> <p>Changeable During Run — No</p>
<p>Always ON Terminal 1</p> <p>Program ⇒ Terminal ⇒ Input Terminals ⇒ ON</p> <p>This parameter is used to set the functionality of the virtual discrete input terminal ON. As a virtual terminal, the ON control terminal exists only in memory and is considered to always be in its True (connected to CC) state.</p> <p>It is often practical to assign a function to this terminal that the user desires to be maintained regardless of external conditions or operations.</p> <p>This parameter sets the programmable ON terminal to one of the user-selectable functions listed in Table 5 on pg. 234.</p>	<p>Direct Access Number — F110</p> <p>Parameter Type — Selection List</p> <p>Factory Default — Unassigned</p> <p>Changeable During Run — No</p>
<p>Input Terminal 1 (F) Function</p> <p>Program ⇒ Terminal ⇒ Input Terminals</p> <p>This parameter is used to set the functionality of the F discrete input terminal. In addition, this input terminal must be specified as Normally Open or Normally Closed.</p> <p>This parameter sets the programmable F terminal to one of the user-selectable functions listed in Table 5 on pg. 234.</p>	<p>Direct Access Number — F111</p> <p>Parameter Type — Selection List</p> <p>Factory Default—Forward</p> <p>Changeable During Run — No</p>
<p>Input Terminal 2 (R) Function</p> <p>Program ⇒ Terminal ⇒ Input Terminals</p> <p>This parameter is used to set the functionality of the R discrete input terminal. In addition, this input terminal must be specified as Normally Open or Normally Closed.</p> <p>This parameter sets the programmable R terminal to one of the user-selectable functions listed in Table 5 on pg. 234.</p>	<p>Direct Access Number — F112</p> <p>Parameter Type — Selection List</p> <p>Factory Default — Reverse Reverse</p> <p>Changeable During Run — No</p>
<p>Input Terminal 3 (ST) Function</p> <p>Program ⇒ Terminal ⇒ Input Terminals</p> <p>This parameter is used to set the functionality of the ST (Standby) discrete input terminal.</p> <p>In addition, this input terminal must be specified as Normally Open or Normally Closed.</p> <p>This parameter sets the programmable ST terminal to one of the user-selectable functions listed in Table 5 on pg. 234.</p>	<p>Direct Access Number — F113</p> <p>Parameter Type — Selection List</p> <p>Factory Default — Standby</p> <p>Changeable During Run — No</p>

<p>Input Terminal 4 (RES) Function</p> <p>Program ⇒ Terminal ⇒ Input Terminals</p> <p>This parameter is used to set the functionality of the RES discrete input terminal.</p> <p>In addition, this input terminal must be specified as Normally Open or Normally Closed.</p> <p>This parameter sets the programmable RES terminal to one of the user-selectable functions listed in Table 5 on pg. 234.</p>	<p>Direct Access Number — F114</p> <p>Parameter Type — Selection List</p> <p>Factory Default — Reset</p> <p>Changeable During Run — No</p>
<p>Input Terminal 5 (S1) Function</p> <p>Program ⇒ Terminal ⇒ Input Terminals</p> <p>This parameter is used to set the functionality of the S1 discrete input terminal.</p> <p>In addition, this input terminal must be specified as Normally Open or Normally Closed.</p> <p>This parameter sets the programmable S1 terminal to one of the user-selectable functions listed in Table 5 on pg. 234.</p>	<p>Direct Access Number — F115</p> <p>Parameter Type — Selection List</p> <p>Factory Default — Preset Speed 1</p> <p>Changeable During Run — No</p>
<p>Input Terminal 6 (S2) Function</p> <p>Program ⇒ Terminal ⇒ Input Terminals</p> <p>This parameter is used to set the functionality of the S2 discrete input terminal.</p> <p>In addition, this input terminal must be specified as Normally Open or Normally Closed.</p> <p>This parameter sets the programmable S2 terminal to one of the user-selectable functions listed in Table 5 on pg. 234.</p>	<p>Direct Access Number — F116</p> <p>Parameter Type — Selection List</p> <p>Factory Default — Preset Speed 2</p> <p>Changeable During Run — No</p>
<p>Input Terminal 7 (S3) Function</p> <p>Program ⇒ Terminal ⇒ Input Terminals</p> <p>This parameter is used to set the functionality of the S3 discrete input terminal.</p> <p>In addition, this input terminal must be specified as Normally Open or Normally Closed.</p> <p>This parameter sets the programmable S3 terminal to one of the user-selectable functions listed in Table 5 on pg. 234.</p>	<p>Direct Access Number — F117</p> <p>Parameter Type — Selection List</p> <p>Factory Default — Preset Speed 3</p> <p>Changeable During Run — No</p>
<p>Input Terminal 8 (S4) Function</p> <p>Program ⇒ Terminal ⇒ Input Terminals</p> <p>This parameter is used to set the functionality of the S4 discrete input terminal.</p> <p>In addition, this input terminal must be specified as Normally Open or Normally Closed.</p> <p>This parameter sets the programmable S4 terminal to one of the user-selectable functions listed in Table 5 on pg. 234.</p>	<p>Direct Access Number — F118</p> <p>Parameter Type — Selection List</p> <p>Factory Default — Preset Speed 4</p> <p>Changeable During Run — No</p>

Input Terminal 9 (LI1) Function

Program ⇒ Terminal ⇒ Input Terminals

This parameter is used to set the functionality of the **LI1** discrete input terminal.

In addition, this input terminal must be specified as **Normally Open** or **Normally Closed**.

This setting assigns the function of the programmable **LI1** terminal to one of the user-selectable functions listed in [Table 5 on pg. 234](#).

Note: The Expansion IO Card Option 1 option board (P/N ETB003Z) is required to use this terminal.

See the **Expansion IO Card Option 1** instruction manual (P/N 58685) for more information on the function of this terminal.

Direct Access Number — F119Parameter Type — **Selection List**Factory Default — **Unassigned**Changeable During Run — **No**

Input Terminal 10 (LI2) Function

Program ⇒ Terminal ⇒ Input Terminals

This parameter is used to set the functionality of the **LI2** discrete input terminal.

In addition, this input terminal must be specified as **Normally Open** or **Normally Closed**.

This setting assigns the function of the programmable **LI2** terminal to one of the user-selectable functions listed in [Table 5 on pg. 234](#).

Note: The Expansion IO Card Option 1 option board (P/N ETB003Z) is required to use this terminal.

See the **Expansion IO Card Option 1** instruction manual (P/N 58685) for more information on the function of this terminal.

Direct Access Number — F120Parameter Type — **Selection List**Factory Default — **Unassigned**Changeable During Run — **No**

Input Terminal 11 (LI3) Function

Program ⇒ Terminal ⇒ Input Terminals

This parameter is used to set the functionality of the **LI3** discrete input terminal.

In addition, this input terminal must be specified as **Normally Open** or **Normally Closed**.

This setting assigns the function of the programmable **LI3** terminal to one of the user-selectable functions listed in [Table 5 on pg. 234](#).

Note: The Expansion IO Card Option 1 option board (P/N ETB003Z) is required to use this terminal.

See the **Expansion IO Card Option 1 instruction manual** (P/N 58685) for more information on the function of this terminal.

Direct Access Number — F121Parameter Type — **Selection List**Factory Default — **Unassigned**Changeable During Run — **No**

Input Terminal 12 (LI4) Function

Program ⇒ Terminal ⇒ Input Terminals

This parameter is used to set the functionality of the **LI4** discrete input terminal.

In addition, this input terminal must be specified as **Normally Open** or **Normally Closed**.

This setting assigns the function of the programmable **LI4** terminal to one of the user-selectable functions listed in [Table 5 on pg. 234](#).

Note: The **Expansion IO Card Option 1** option board (P/N ETB003Z) is required to use this terminal.

See the **Expansion IO Card Option 1** instruction manual (P/N 58685) for more information on the function of this terminal.

Direct Access Number — F122Parameter Type — **Selection List**Factory Default — **Unassigned**Changeable During Run — **No**

Input Terminal 13 (LI5) Function

Program ⇒ Terminal ⇒ Input Terminals

This parameter is used to set the functionality of the **LI5** discrete input terminal.

In addition, this input terminal must be specified as **Normally Open** or **Normally Closed**.

This setting assigns the function of the programmable **LI5** terminal to one of the user-selectable functions listed in [Table 5 on pg. 234](#).

Note: The **Expansion IO Card Option 2** option board (P/N ETB004Z) is required to use this terminal.

See the **Expansion IO Card Option 2** instruction manual (P/N 58686) for more information on the function of this terminal.

Direct Access Number — F123Parameter Type — **Selection List**Factory Default — **Unassigned**Changeable During Run — **No**

Input Terminal 14 (LI6) Function

Program ⇒ Terminal ⇒ Input Terminals

This parameter is used to set the functionality of the **LI6** discrete input terminal.

In addition, this input terminal must be specified as **Normally Open** or **Normally Closed**.

This setting assigns the function of the programmable **LI6** terminal to one of the user-selectable functions listed in [Table 5 on pg. 234](#).

Note: The **Expansion IO Card Option 2** option board (P/N ETB004Z) is required to use this terminal.

See the **Expansion IO Card Option 2** instruction manual (P/N 58686) for more information on the function of this terminal.

Direct Access Number — F124Parameter Type — **Selection List**Factory Default — **Unassigned**Changeable During Run — **No**

Input Terminal 15 (LI7) Function

Program ⇒ Terminal ⇒ Input Terminals

This parameter is used to set the functionality of the **LI7** discrete input terminal.

In addition, this input terminal must be specified as **Normally Open** or **Normally Closed**.

This setting assigns the function of the programmable **LI7** terminal to one of the user-selectable functions listed in [Table 5 on pg. 234](#).

Note: The **Expansion IO Card Option 2** option board (P/N ETB004Z) is required to use this terminal.

See the **Expansion IO Card Option 2** instruction manual (P/N 58686) for more information on the function of this terminal.

Direct Access Number — F125Parameter Type — **Selection List**Factory Default — **Unassigned**Changeable During Run — **No**

Input Terminal 16 (LI8) Function

Program ⇒ Terminal ⇒ Input Terminals

This parameter is used to set the functionality of the **LI8** discrete input terminal.

In addition, this input terminal must be specified as **Normally Open** or **Normally Closed**.

This setting assigns the function of the programmable **LI8** terminal to one of the user-selectable functions listed in [Table 5 on pg. 234](#).

Note: The **Expansion IO Card Option 2** option board (P/N ETB004Z) is required to use this terminal.

See the **Expansion IO Card Option 2** instruction manual (P/N 58686) for more information on the function of this terminal.

Direct Access Number — F126Parameter Type — **Selection List**Factory Default — **Unassigned**Changeable During Run — **No**

Output Terminal 1 (OUT1) Function

Program ⇒ Terminal ⇒ Output Terminals

This parameter is used to set the functionality of the **OUT1** discrete output terminals **O1A** and **O1B**.

The **O1A** and **O1B** (OUT1) output terminals change states (open or close) as a function of a user-selected event. See [Table 8 on pg. 239](#) for listing the possible assignments for the **OUT1** terminals.

In addition, the output terminals must be specified as **Normally Open** or **Normally Closed**.

Direct Access Number — F130Parameter Type — **Selection List**Factory Default — **Low-Speed Signal**Changeable During Run — **No**

Output Terminal 2 (OUT2) Function

Program ⇒ Terminal ⇒ Output Terminals

This parameter is used to set the functionality of the **OUT2** discrete output terminals **O2A** and **O2B**.

The **O2A** and **O2B** (OUT2) output terminals change states (open or close) as a function of a user-selected event. See [Table 8 on pg. 239](#) for listing the possible assignments for the **OUT2** terminals.

In addition, the output terminals must be specified as **Normally Open** or **Normally Closed**.

Direct Access Number — F131Parameter Type — **Selection List**Factory Default — **RCH (Acc/Dec Complete)**Changeable During Run — **No**

Output Terminal 3 (FL) Function

Program ⇒ Terminal ⇒ Output Terminals

This parameter is used to set the functionality of the **FL** output terminals to one of the user-selectable functions listed in [Table 8 on pg. 239](#).

In addition, the output terminals must be specified as **Normally Open** or **Normally Closed**.

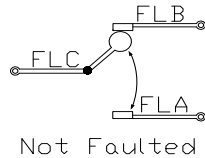

Direct Access Number — F132

Parameter Type — Selection List

Factory Default — Fault (All)

Changeable During Run — No

Output Terminal 4 (OUT3) Function

Program ⇒ Terminal ⇒ Output Terminals

This parameter is used to set the functionality of the **OUT3** discrete output terminal.

In addition, this input terminal must be specified as **Normally Open** or **Normally Closed**.

This setting assigns the function of the programmable **OUT3** terminal to one of the user-selectable functions listed in [Table 8 on pg. 239](#).

Note: The *Expansion IO Card Option 1* option board (P/N ETB003Z) is required to use this terminal.

See the **Expansion IO Card Option 1** instruction manual (P/N 58685) for more information on the function of this terminal.

Direct Access Number — F133

Parameter Type — Selection List

Factory Default — Always OFF

Changeable During Run — No

Output Terminal 5 (OUT4) Function

Program ⇒ Terminal ⇒ Output Terminals

This parameter is used to set the functionality of the **OUT4** discrete output terminal.

In addition, this input terminal must be specified as **Normally Open** or **Normally Closed**.

This setting assigns the function of the programmable **OUT4** terminal to one of the user-selectable functions listed in [Table 8 on pg. 239](#).

Note: The *Expansion IO Card Option 1* option board (P/N ETB003Z) is required to use this terminal.

See the **Expansion IO Card Option 1** instruction manual (P/N 58685) for more information on the function of this terminal.

Direct Access Number — F134

Parameter Type — Selection List

Factory Default — Always OFF

Changeable During Run — No

Output Terminal 6 (R1) Function

Program ⇒ Terminal ⇒ Output Terminals

This parameter is used to set the functionality of the **R1** discrete output terminal.

In addition, this input terminal must be specified as **Normally Open** or **Normally Closed**.

This setting assigns the function of the programmable **R1** terminal to one of the user-selectable functions listed in [Table 8 on pg. 239](#).

Note: The **Expansion IO Card Option 1** option board (P/N ETB003Z) is required to use this terminal.

See the **Expansion IO Card Option 1** instruction manual (P/N 58685) for more information on the function of this terminal.

Output Terminal 7 (OUT5) Function

Program ⇒ Terminal ⇒ Output Terminals

This parameter is used to set the functionality of the **OUT5** discrete output terminal.

In addition, this output terminal must be specified as **Normally Open** or **Normally Closed**.

This setting assigns the function of the programmable **OUT5** terminal to one of the user-selectable functions listed in [Table 8 on pg. 239](#).

Note: The **Expansion IO Card Option 2** option board (P/N ETB004Z) is required to use this terminal.

See the **Expansion IO Card Option 2** instruction manual (P/N 58686) for more information on the function of this terminal.

Output Terminal 8 (OUT6) Function

Program ⇒ Terminal ⇒ Output Terminals

This parameter is used to set the functionality of the **OUT6** discrete output terminal.

In addition, this output terminal must be specified as **Normally Open** or **Normally Closed**.

This setting assigns the function of the programmable **OUT6** terminal to one of the user-selectable functions listed in [Table 8 on pg. 239](#).

Note: The **Expansion IO Card Option 2** option board (P/N ETB004Z) is required to use this terminal.

See the **Expansion IO Card Option 2** instruction manual (P/N 58686) for more information on the function of this terminal.

Direct Access Number — F135Parameter Type — **Selection List**Factory Default — **Always OFF**Changeable During Run — **No**

Direct Access Number — F136Parameter Type — **Selection List**Factory Default — **Always Off**Changeable During Run — **No**

Direct Access Number — F137Parameter Type — **Selection List**Factory Default — **Always Off**Changeable During Run — **No**

Output Terminal 9 (R2) Function

Program ⇒ Terminal ⇒ Output Terminals

This parameter is used to set the functionality of the **R2** discrete output terminal.

In addition, this output terminal must be specified as **Normally Open** or **Normally Closed**.

This setting assigns the function of the programmable **R2** terminal to one of the user-selectable functions listed in [Table 8 on pg. 239](#).

Note: The Expansion IO Card Option 2 option board (P/N ETB004Z) is required to use this terminal.

See the **Expansion IO Card Option 2** instruction manual (P/N 58686) for more information on the function of this terminal.

Direct Access Number — F138

Parameter Type — Selection List

Factory Default — Always Off

Changeable During Run — No

Input Terminal 1 (F) Response Time

Program ⇒ Terminal ⇒ Input Terminal Delays

This parameter delays the response of the ASD to any change in the **F** terminal input by the programmed value.

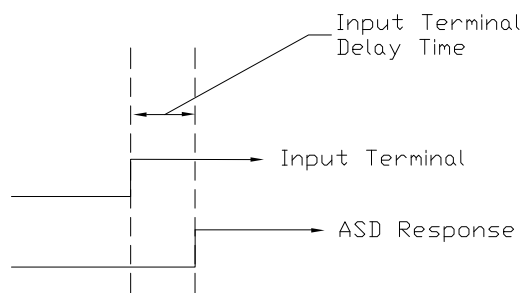

The delay may be increased to provide additional electrical noise immunity or to prevent the ASD from responding to contact bounce or chatter.

Direct Access Number — F140

Parameter Type — Numerical

Factory Default — 8.0

Changeable During Run — No

Minimum — 2.0

Maximum — 200.0

Units — mS

Input Terminal 2 (R) Response Time

Program ⇒ Terminal ⇒ Input Terminal Delays

This parameter delays the response of the drive to any change in the **R** terminal input by the programmed value (see waveforms at [F140](#)).

The delay may be increased to provide additional electrical noise immunity or to prevent the ASD from responding to contact bounce or chatter.

Direct Access Number — F141

Parameter Type — Numerical

Factory Default — 8.0

Changeable During Run — No

Minimum — 2.0

Maximum — 200.0

Units — mS

Input Terminal 3 (ST) Response Time

Program ⇒ Terminal ⇒ Input Terminal Delays

This parameter delays the response of the drive to any change in the **ST** terminal input by the programmed value (see waveforms at [F140](#)).

The delay may be increased to provide additional electrical noise immunity or to prevent the ASD from responding to contact bounce or chatter.

Direct Access Number — F142

Parameter Type — Numerical

Factory Default — 8.0

Changeable During Run — No

Minimum — 2.0

Maximum — 200.0

Units — mS

<p>Input Terminal 4 (RES) Response Time</p> <p>Program ⇒ Terminal ⇒ Input Terminal Delays</p> <p>This parameter delays the response of the drive to any change in the RES terminal input by the programmed value (see waveforms at F140).</p> <p>The delay may be increased to provide additional electrical noise immunity or to prevent the ASD from responding to contact bounce or chatter.</p>	<p>Direct Access Number — F143</p> <p>Parameter Type — Numerical</p> <p>Factory Default — 8.0</p> <p>Changeable During Run — No</p> <p>Minimum — 2.0</p> <p>Maximum — 200.0</p> <p>Units — mS</p>
<p>Input Terminal 5 – 12 Response Time</p> <p>Program ⇒ Terminal ⇒ Input Terminal Delays</p> <p>This parameter delays the response of the drive to any change in the 5 – 12 terminal inputs by the programmed value (see waveforms at F140).</p> <p>The delay may be increased to provide additional electrical noise immunity or to prevent the ASD from responding to contact bounce or chatter.</p>	<p>Direct Access Number — F144</p> <p>Parameter Type — Numerical</p> <p>Factory Default — 8.0</p> <p>Changeable During Run — No</p> <p>Minimum — 2.0</p> <p>Maximum — 200.0</p> <p>Units — mS</p>
<p>Input Terminal 13 – 20 Response Time</p> <p>Program ⇒ Terminal ⇒ Input Terminal Delays</p> <p>This parameter delays the response of the drive to any change in the 13 – 20 terminal inputs by the programmed value (see waveforms at F140).</p> <p>The delay may be increased to provide additional electrical noise immunity or to prevent the ASD from responding to contact bounce or chatter.</p>	<p>Direct Access Number — F145</p> <p>Parameter Type — Numerical</p> <p>Factory Default — 8.0</p> <p>Changeable During Run — No</p> <p>Minimum — 2.0</p> <p>Maximum — 200.0</p> <p>Units — mS</p>
<p>Input Terminal 17 (B12) Function</p> <p>Program ⇒ Terminal ⇒ Input Terminals</p> <p>This parameter is used to set the functionality of the B12 discrete input terminal.</p> <p>In addition, this input terminal must be specified as Normally Open or Normally Closed.</p> <p>This setting assigns the functionality of the programmable B12 terminal to any one of the user-selectable functions listed in Table 5 on pg. 234.</p> <p>See the My Function Instruction Manual (P/N E6581335) for more information on the function of this terminal.</p>	<p>Direct Access Number — F164</p> <p>Parameter Type — Selection List</p> <p>Factory Default — Unassigned</p> <p>Changeable During Run — No</p>
<p>Input Terminal 18 (B13) Function</p> <p>Program ⇒ Terminal ⇒ Input Terminals</p> <p>This parameter is used to set the functionality of the B13 discrete input terminal.</p> <p>In addition, this input terminal must be specified as Normally Open or Normally Closed.</p> <p>This setting assigns the function of the programmable B13 terminal to any one of the user-selectable functions listed in Table 5 on pg. 234.</p> <p>See the My Function Instruction Manual (P/N E6581335) for more information on the function of this terminal.</p>	<p>Direct Access Number — F165</p> <p>Parameter Type — Selection List</p> <p>Factory Default — Unassigned</p> <p>Changeable During Run — No</p>

<p>Input Terminal 19 (B14) Function</p> <p>Program ⇒ Terminal ⇒ Input Terminals</p> <p>This parameter is used to set the functionality of the B14 discrete input terminal.</p> <p>In addition, this input terminal must be specified as Normally Open or Normally Closed.</p> <p>This setting assigns the function of the programmable B14 terminal to any one of the user-selectable functions listed in Table 5 on pg. 234.</p> <p>See the My Function Instruction Manual (P/N E6581335) for more information on the function of this terminal.</p>	<p>Direct Access Number — F166</p> <p>Parameter Type — Selection List</p> <p>Factory Default — Unassigned</p> <p>Changeable During Run — No</p>
<p>Input Terminal 20 (B15) Function</p> <p>Program ⇒ Terminal ⇒ Input Terminals</p> <p>This parameter is used to set the functionality of the B15 discrete input terminal.</p> <p>In addition, this input terminal must be specified as Normally Open or Normally Closed.</p> <p>This setting assigns the function of the programmable B15 terminal to any one of the user-selectable functions listed in Table 5 on pg. 234.</p> <p>See the My Function Instruction Manual (P/N E6581335) for more information on the function of this terminal.</p>	<p>Direct Access Number — F167</p> <p>Parameter Type — Selection List</p> <p>Factory Default — Unassigned</p> <p>Changeable During Run — No</p>
<p>Output Terminal 10 (R3) Function</p> <p>Program ⇒ Terminal ⇒ Output Terminals</p> <p>This parameter sets the functionality of the R3 output terminal to any one of the user-selectable functions listed in Table 8 on pg. 239.</p> <p>In addition, the output terminals must be specified as Normally Open or Normally Closed.</p> <p>See the instruction manual for the 16-Bit BIN/BCD option for more information on the function of this terminal.</p>	<p>Direct Access Number — F168</p> <p>Parameter Type — Selection List</p> <p>Factory Default — OFF</p> <p>Changeable During Run — No</p>
<p>Output Terminal 11 (R4) Function</p> <p>Program ⇒ Terminal ⇒ Output Terminals</p> <p>This parameter sets the functionality of the R4 output terminal to any one of the user-selectable functions listed in Table 8 on pg. 239.</p> <p>In addition, the output terminals must be specified as Normally Open or Normally Closed.</p> <p>See the instruction manual for the 16-Bit BIN/BCD option for more information on the function of this terminal.</p>	<p>Direct Access Number — F169</p> <p>Parameter Type — Selection List</p> <p>Factory Default — OFF</p> <p>Changeable During Run — No</p>

<p>Base Frequency 2</p> <p>Program ⇒ Motor ⇒ Motor Set 2</p> <p>The Base Frequency 2 setting is the frequency at which the output voltage of the ASD reaches its maximum setting. The Base Frequency Voltage 2 parameter is set at F171.</p> <p>This parameter is used only when the parameters for Motor Set 2 are configured and selected. Motor Set 2 may be selected by a properly configured input terminal (see Table 5 on pg. 234).</p> <p>For proper motor operation, the Base Frequency should be set for the nameplated frequency of the motor.</p>	<p>Direct Access Number — F170</p> <p>Parameter Type — Numerical</p> <p>Factory Default — 60.0</p> <p>Changeable During Run — Yes</p> <p>Minimum — 25.0</p> <p>Maximum — 299.0</p> <p>Units — Hz</p>
<p>Base Frequency Voltage 2</p> <p>Program ⇒ Motor ⇒ Motor Set 2</p> <p>The Base Frequency Voltage 2 setting is the Motor 2 output voltage at the Base Frequency (F170). Regardless of the programmed value, the output voltage cannot be higher than the input voltage.</p> <p>The actual output voltage will be influenced by the input voltage of the ASD and the Supply Voltage Compensation setting (F307).</p> <p>This parameter is used only when the parameters for Motor Set 2 are configured and selected. Motor Set 2 may be selected by a properly configured input terminal (see Table 5 on pg. 234).</p>	<p>Direct Access Number — F171</p> <p>Parameter Type — Numerical</p> <p>Factory Default — (ASD-Dependent)</p> <p>Changeable During Run — Yes</p> <p>Minimum — 50.0</p> <p>Maximum — 660.0</p> <p>Units — Volts</p>
<p>Manual Torque Boost 2</p> <p>Program ⇒ Motor ⇒ Motor Set 2</p> <p>The Manual Torque Boost 2 function is used to increase the low frequency torque for high inertia loads by increasing the output voltage at frequencies below ½ of the Base Frequency 2 setting (F170).</p> <p>See parameter F016 (Manual Torque Boost 1) for an explanation of torque boost.</p> <p>This parameter is used only when the parameters for Motor Set 2 are configured and selected. Motor Set 2 may be selected by a properly configured input terminal (see Table 5 on pg. 234).</p>	<p>Direct Access Number — F172</p> <p>Parameter Type — Numerical</p> <p>Factory Default — (ASD-Dependent)</p> <p>Changeable During Run — Yes</p> <p>Minimum — 0.0</p> <p>Maximum — 30.0</p> <p>Units — %</p>
<p>Motor Overload Protection Level 2</p> <p>Program ⇒ Motor ⇒ Motor Set 2</p> <p>The Motor 2 Overload Protection Level parameter specifies the motor overload current level for Motor Set 2. This value is entered as either a percentage of the full load rating of the ASD or as the FLA of the motor.</p> <p>The unit of measurement for this parameter may be set to Amps (A/V) or it may be set as a percentage of the ASD rating. The nameplated FLA of the motor may be entered directly when Amps is selected as the unit of measurement (see F701 to change the display unit).</p> <p>The Motor 2 Overload Protection Level setting will be displayed in Amps if the EOI display units are set to A/V rather than %.</p>	<p>Direct Access Number — F173</p> <p>Parameter Type — Numerical</p> <p>Factory Default — 100</p> <p>Changeable During Run — Yes</p> <p>Minimum — 10</p> <p>Maximum — 100</p> <p>Units — %</p>

<p>Base Frequency 3</p> <p>Program ⇒ Motor ⇒ Motor Set 3</p> <p>The Base Frequency 3 setting is the frequency at which the output voltage of the ASD reaches its maximum setting. The Base Frequency Voltage 3 parameter is set at F175.</p> <p>This parameter is used only when the parameters for Motor Set 3 are configured and selected. Motor Set 3 may be selected by a properly configured input terminal (see Table 5 on pg. 234).</p> <p>For proper motor operation, the Base Frequency should be set for the nameplated frequency of the motor.</p>	<p>Direct Access Number — F174</p> <p>Parameter Type — Numerical</p> <p>Factory Default — 60.0</p> <p>Changeable During Run — Yes</p> <p>Minimum — 25.0</p> <p>Maximum — 299.0</p> <p>Units — Hz</p>
<p>Base Frequency Voltage 3</p> <p>Program ⇒ Motor ⇒ Motor Set 3</p> <p>The Base Frequency Voltage 3 setting is the Motor 3 output voltage at the Base Frequency (F174). Regardless of the programmed value, the output voltage cannot be higher than the input voltage.</p> <p>The actual output voltage will be influenced by the input voltage of the ASD and the Supply Voltage Compensation setting (F307).</p> <p>This parameter is used only when the parameters for Motor Set 3 are configured and selected. Motor Set 3 may be selected by a properly configured input terminal (see Table 5 on pg. 234).</p>	<p>Direct Access Number — F175</p> <p>Parameter Type — Numerical</p> <p>Factory Default — (ASD-Dependent)</p> <p>Changeable During Run — Yes</p> <p>Minimum — 50.0</p> <p>Maximum — 660.0</p> <p>Units — Volts</p>
<p>Manual Torque Boost 3</p> <p>Program ⇒ Motor ⇒ Motor Set 3</p> <p>The Manual Torque Boost 3 function is used to increase the low frequency torque for high inertia loads by increasing the output voltage at frequencies below ½ of the Base Frequency 3 setting (F174).</p> <p>See parameter F016 (Manual Torque Boost 1) for an explanation of torque boost.</p> <p>This parameter is used only when the parameters for Motor Set 3 are configured and selected. Motor Set 3 may be selected by a properly configured input terminal (see Table 5 on pg. 234).</p>	<p>Direct Access Number — F176</p> <p>Parameter Type — Numerical</p> <p>Factory Default — (ASD-Dependent)</p> <p>Changeable During Run — Yes</p> <p>Minimum — 0.0</p> <p>Maximum — 30.0</p> <p>Units — %</p>
<p>Motor Overload Protection Level 3</p> <p>Program ⇒ Motor ⇒ Motor Set 3</p> <p>The Motor 3 Overload Protection Level parameter specifies the motor overload current level for Motor Set 3. This value is entered as either a percentage of the full load rating of the ASD or as the FLA of the motor.</p> <p>The unit of measurement for this parameter may be set to Amps (A/V) or it may be set as a percentage of the ASD rating. The nameplated FLA of the motor may be entered directly when Amps is selected as the unit of measurement (see F701 to change the display unit).</p> <p>The Motor 3 Overload Protection Level setting will be displayed in Amps if the EOI display units are set to A/V rather than %.</p>	<p>Direct Access Number — F177</p> <p>Parameter Type — Numerical</p> <p>Factory Default — 100.0</p> <p>Changeable During Run — Yes</p> <p>Minimum — 10</p> <p>Maximum — 100</p> <p>Units — %</p>

<p>Base Frequency 4</p> <p>Program ⇒ Motor ⇒ Motor Set 4</p> <p>The Base Frequency 4 setting is the frequency at which the output voltage of the ASD reaches its maximum setting. The Base Frequency Voltage 4 parameter is set at F179.</p> <p>This parameter is used only when the parameters for Motor Set 4 are configured and selected. Motor Set 4 may be selected by a properly configured input terminal (see Table 5 on pg. 234).</p> <p>For proper motor operation, the Base Frequency should be set for the nameplated frequency of the motor.</p>	<p>Direct Access Number — F178</p> <p>Parameter Type — Numerical</p> <p>Factory Default — 60.0</p> <p>Changeable During Run — Yes</p> <p>Minimum — 25.00</p> <p>Maximum — 299.0</p> <p>Units — Hz</p>
<p>Base Frequency Voltage 4</p> <p>Program ⇒ Motor ⇒ Motor Set 4</p> <p>The Base Frequency Voltage 4 is the Motor 4 output voltage at the Base Frequency (F178). Regardless of the programmed value, the output voltage cannot be higher than the input voltage.</p> <p>The actual output voltage will be influenced by the input voltage of the ASD and the Supply Voltage Compensation setting (F307).</p> <p>This parameter is used only when the parameters for Motor Set 4 are configured and selected. Motor Set 4 may be selected by a properly configured input terminal (see Table 5 on pg. 234).</p>	<p>Direct Access Number — F179</p> <p>Parameter Type — Numerical</p> <p>Factory Default — (ASD-Dependent)</p> <p>Changeable During Run — Yes</p> <p>Minimum — 50.0</p> <p>Maximum — 660.0</p> <p>Units — Volts</p>
<p>Manual Torque Boost 4</p> <p>Program ⇒ Motor ⇒ Motor Set 4</p> <p>The Manual Torque Boost 4 function is used to increase the low frequency torque for high inertia loads by increasing the output voltage at frequencies below ½ of the 4 Base Frequency setting (F178).</p> <p>See parameter F016 (Manual Torque Boost 1) for an explanation of torque boost.</p> <p>This parameter is used only when the parameters for Motor Set 4 are configured and selected. Motor Set 4 may be selected by a properly configured input terminal (see Table 5 on pg. 234).</p>	<p>Direct Access Number — F180</p> <p>Parameter Type — Numerical</p> <p>Factory Default — (ASD-Dependent)</p> <p>Changeable During Run — Yes</p> <p>Minimum — 0.0</p> <p>Maximum — 30.0</p> <p>Units — %</p>
<p>Motor Overload Protection Level 4</p> <p>Program ⇒ Motor ⇒ Motor Set 4</p> <p>The Motor 4 Overload Protection Level parameter specifies the motor overload current level for Motor Set 4. This value is entered as either a percentage of the full load rating of the ASD or as the FLA of the motor.</p> <p>The unit of measurement for this parameter may be set to Amps (A/V) or it may be set as a percentage of the ASD rating. The nameplated FLA of the motor may be entered directly when Amps is selected as the unit of measurement (see F701 to change the display unit).</p> <p>The Motor 4 Overload Protection Level setting will be displayed in Amps if the EOI display units are set to A/V rather than %.</p>	<p>Direct Access Number — F181</p> <p>Parameter Type — Numerical</p> <p>Factory Default — 100.0</p> <p>Changeable During Run — Yes</p> <p>Minimum — 10</p> <p>Maximum — 100</p> <p>Units — %</p>

V/f 5-Point Setting Frequency 1

Program ⇒ Special ⇒ V/f 5-Point Setting

The **V/f 5-Point Setting Frequency 1** setting establishes the frequency that is to be associated with the voltage setting of **F191** (V/f 5-Point Setting Voltage 1).

The V/f 5-Point settings define a volts per hertz relationship for the startup output of the ASD.

To enable this function, set the **V/f Pattern** (**F015**) selection to the **V/f 5-Point Curve** setting.

V/f Curves may be useful in starting high inertia loads such as rotary drum vacuum filters.

Direct Access Number — F190

Parameter Type — Numerical

Factory Default — 0.00

Changeable During Run — No

Minimum — 0.00

Maximum — **Max. Freq. (F011)**

Units — Hz

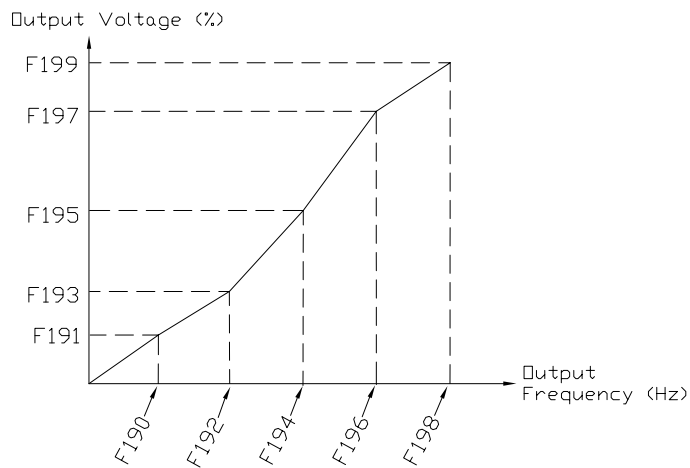

V/f 5-Point Setting Voltage 1

Program ⇒ Special ⇒ V/f 5-Point Setting

The **V/f 5-Point Setting Voltage 1** establishes the output voltage level that is to be associated with the frequency setting of **F190** (V/f 5-Point Setting Frequency 1).

The **F701** parameter setting will determine if the on-screen selection for this parameter appears in the form of a Voltage (V) or as a Percentage (%) of the ASD rating.

If using **Voltage** as a unit of measure and with no voltage correction (**F307** Disabled), the limit of the on-screen display value for this parameter is 200 volts for the 230-volt ASD and 400 volts for the 460-volt ASD.

The actual output voltage is scaled to the maximum EOI display values (e.g., a 100-volt EOI display corresponds to a 115-volt actual output for the 230-volt ASD — ½ of the full display range).

If using **%** as a unit of measure and with no voltage correction (**F307** Disabled), the ASD output voltage will be the percentage setting times 230 for the 230-volt unit (or % times 460 volts for the 460-volt unit).

See **F190** for additional information on this setting.

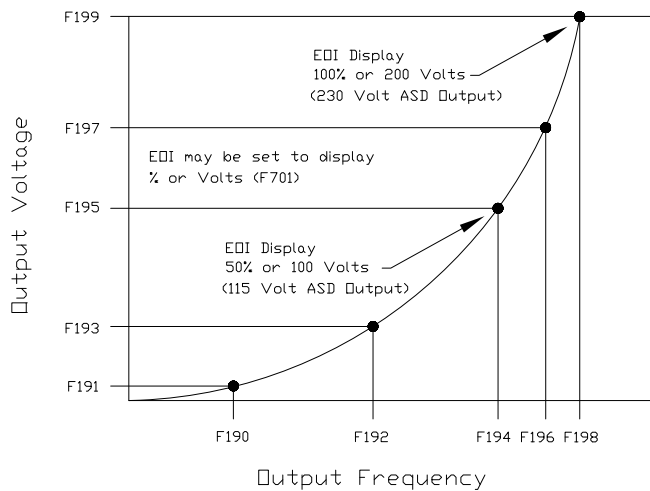

Direct Access Number — F191

Parameter Type — Numerical

Factory Default — 0.0

Changeable During Run — No

Minimum — 0.0

Maximum — 100.0

Units — V or % (F701)

V/f 5-Point Setting Frequency 2

Program ⇒ Special ⇒ V/f 5-Point Setting

The **V/f 5-Point Setting Frequency 2** sets the frequency to be associated with the voltage setting of parameter **F193** (V/f 5-Point Setting Voltage 2).

See **F190** and **F191** for additional information on this setting.

Direct Access Number — F192

Parameter Type — Numerical

Factory Default — 0.00

Changeable During Run — No

Minimum — 0.00

Maximum — Max. Freq. (F011)

Units — Hz

<p>V/f 5-Point Setting Voltage 2</p> <p>Program ⇒ Special ⇒ V/f 5-Point Setting</p> <p>The V/f 5-Point Setting Voltage 2 establishes the output voltage level that is to be associated with the frequency setting of F192 (V/f 5-Point Setting Frequency 2).</p> <p>The F701 parameter setting will determine if the selection for this parameter appears in the form of a Voltage (V) or as a Percentage (%) of the ASD rating. The default setting is %.</p> <p>See F190 and F191 for additional information on this setting.</p>	<p>Direct Access Number — F193</p> <p>Parameter Type — Numerical</p> <p>Factory Default — 0.0</p> <p>Changeable During Run — No</p> <p>Minimum — 0.0</p> <p>Maximum — 100.0</p> <p>Units — V or % (F701)</p>
<p>V/f 5-Point Setting Frequency 3</p> <p>Program ⇒ Special ⇒ V/f 5-Point Setting</p> <p>The V/f 5-Point Setting Frequency 3 sets the frequency to be associated with the voltage setting of parameter F195 (V/f 5-Point Setting Voltage 3).</p> <p>See F190 and F191 for additional information on this setting.</p>	<p>Direct Access Number — F194</p> <p>Parameter Type — Numerical</p> <p>Factory Default — 0.00</p> <p>Changeable During Run — No</p> <p>Minimum — 0.00</p> <p>Maximum — Max. Freq. (F011)</p> <p>Units — Hz</p>
<p>V/f 5-Point Setting Voltage 3</p> <p>Program ⇒ Special ⇒ V/f 5-Point Setting</p> <p>The V/f 5-Point Setting Voltage 3 establishes the output voltage level that is to be associated with the frequency setting of F194 (V/f 5-Point Setting Frequency 3).</p> <p>The F701 parameter setting will determine if the selection for this parameter appears in the form of a Voltage (V) or as a Percentage (%) of the ASD rating. The default setting is %.</p> <p>See F190 and F191 for additional information on this setting.</p>	<p>Direct Access Number — F195</p> <p>Parameter Type — Numerical</p> <p>Factory Default — 0.0</p> <p>Changeable During Run — No</p> <p>Minimum — 0.0</p> <p>Maximum — 100.0</p> <p>Units — V or % (F701)</p>
<p>V/f 5-Point Setting Frequency 4</p> <p>Program ⇒ Special ⇒ V/f 5-Point Setting</p> <p>The V/f 5-Point Setting Frequency 4 sets the frequency to be associated with the voltage setting of parameter F197 (V/f 5-Point Setting Voltage 4).</p> <p>See F190 and F191 for additional information on this setting.</p>	<p>Direct Access Number — F196</p> <p>Parameter Type — Numerical</p> <p>Factory Default — 0.00</p> <p>Changeable During Run — No</p> <p>Minimum — 0.00</p> <p>Maximum — Max. Freq. (F011)</p> <p>Units — Hz</p>
<p>V/f 5-Point Setting Voltage 4</p> <p>Program ⇒ Special ⇒ V/f 5-Point Setting</p> <p>The V/f 5-Point Setting Voltage 4 establishes the output voltage level that is to be associated with the frequency setting of F196 (V/f 5-Point Setting Frequency 4).</p> <p>The F701 parameter setting will determine if the selection for this parameter appears in the form of a Voltage (V) or as a Percentage (%) of the ASD rating. The default setting is %.</p> <p>See F190 and F191 for additional information on this setting.</p>	<p>Direct Access Number — F197</p> <p>Parameter Type — Numerical</p> <p>Factory Default — 0.0</p> <p>Changeable During Run — No</p> <p>Minimum — 0.0</p> <p>Maximum — 100.0</p> <p>Units — V or % (F701)</p>

V/f 5-Point Setting Frequency 5

Program ⇒ Special ⇒ V/f 5-Point Setting

The **V/f 5-Point Setting Frequency 5** sets the frequency to be associated with the voltage setting of parameter **F199** (V/f 5-Point Setting Voltage 5).

See **F190** and **F191** for additional information on this setting.

Direct Access Number — **F198**

Parameter Type — **Numerical**

Factory Default — **0.00**

Changeable During Run — **No**

Minimum — 0.00

Maximum — **Max. Freq. (F011)**

Units — Hz

V/f 5-Point Setting Voltage 5

Program ⇒ Special ⇒ V/f 5-Point Setting

The **V/f 5-Point Setting Voltage 5** establishes the output voltage level that is to be associated with the frequency setting of **F198** (V/f 5-Point Setting Frequency 5).

The **F701** parameter setting will determine if the selection for this parameter appears in the form of a Voltage (V) or as a Percentage (%) of the ASD rating.

The default setting is %.

See **F190** and **F191** for additional information on this setting.

Direct Access Number — **F199**

Parameter Type — **Numerical**

Factory Default — **0.0**

Changeable During Run — **No**

Minimum — 0.0

Maximum — 100.0

Units — V or % (**F701**)

Frequency Priority Selection

Program ⇒ Fundamental ⇒ Standard Mode Selection

Either **Frequency Mode 1** or **Frequency Mode 2** may control the output frequency of the ASD. This parameter determines which of the two will control the output frequency and the conditions in which control will be switched from one to the other.

Note: *Frequency Mode is abbreviated as FMOD.*

Settings:

- 0 — FMOD changed by Terminal Board (Frequency Mode)
- 1 — FMOD (**F208**) (Frequency Mode)

The **Frequency Mode 1** or **Frequency Mode 2** selection specifies the source of the input frequency command signal. These selections are performed at **F004** and **F207**, respectively.

If **FMOD changed by Terminal Board** is selected here, the ASD will follow the control of the discrete input terminal assigned the function of **Frequency Priority**. The discrete terminal **Frequency Priority** will toggle control to and from **Frequency Mode 1** and **Frequency Mode 2** with each activation/deactivation.

If **FMOD (F208)** is selected here, the ASD will follow the control of the **Frequency Mode 1** setting for the duration that the commanded frequency of the **Frequency Mode 1** setting is greater than the setting of **F208**.

If the commanded frequency of the **Frequency Mode 1** setting is less than or equal to the setting of **F208** the ASD will follow the setting of **Frequency Mode 2**.

Direct Access Number — **F200**

Parameter Type — **Selection List**

Factory Default — **FMOD (changed by TB)**

Changeable During Run — **Yes**

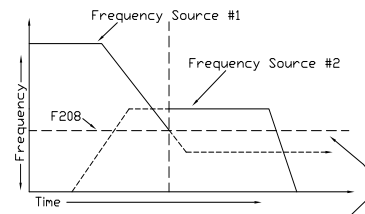

If the frequency command of Frequency Mode 1 is greater than the F208 setting, Frequency Mode 1 has priority over Frequency Mode 2.

If the frequency command of Frequency Mode 1 is equal to or less than the F208 setting, Frequency Mode 2 has priority.

V/I Input Point 1 Setting

Program ⇒ Frequency ⇒ Speed Reference Setpoints

This parameter is used to set the gain and bias of the isolated V/I input terminal when the V/I terminal is used as the control input while operating in the **Speed Control** mode or the **Torque Control** mode.

This parameter sets the V/I input level that is associated with the **V/I Input Point 1 Frequency** setting when operating in the **Speed** control mode or is associated with the **V/I Input Point 1 Rate** setting when operating in the **Torque Control** mode.

V/I Input Speed Control Setup

Perform the following setup to allow the system to receive **Speed** control input at the V/I input terminal:

- Set **SW301** of the **Terminal Board** to **Voltage** or **Current** (see [Figure 9](#) on pg. 24).
- Program ⇒ Fundamental ⇒ Standard Mode Selection ⇒ Frequency Mode 1 ⇒ **V/I**.
- Program ⇒ Fundamental ⇒ Standard Mode Selection ⇒ Command Mode Selection ⇒ **Terminal Block**.

Speed Control

Perform the following setup to allow the system to perform **Speed** control from the V/I input terminal:

- Set **V/I Input Point 1 Frequency** (F202).
- Set **V/I Input Point 1 Setting** (F201) — the input analog signal level that corresponds to the frequency setting at **V/I Input Point 1 Frequency**.
- Set **V/I Input Point 2 Frequency** (F204).
- Set **V/I Input Point 2 Setting** (F203) — the input analog signal level that corresponds to the frequency setting at **V/I Input Point 2 Frequency**.
- Provide a **Run** command (F and/or R).

Once set, as the V/I input voltage or current changes, the output frequency of the ASD will vary in accordance with the above settings.

This parameter value is entered as 0% to 100% of the V/I input signal range.

The V/I input is commonly used for a 4 – 20 mA current loop signal where 4 mA equals 20% of a 20 mA signal. Set this parameter to 20% for 4 – 20 mA current loop signal applications.

Note: When using the isolated V/I input terminal the **IICC** terminal must be used as the return (negative) connection.

Note: If using P24 to power a transducer that is to be used to supply the V/I input signal, it may be necessary to connect **IICC** to **CCA**.

Direct Access Number — F201

Parameter Type — Numerical

Factory Default — 0

Changeable During Run — Yes

Minimum — 0

Maximum — 100

Units — %

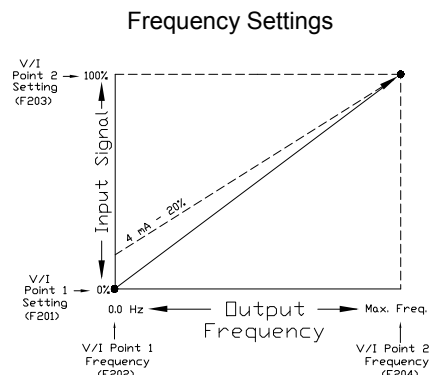

V/I Input Point 1 Frequency

Program ⇒ Frequency ⇒ Speed Reference Setpoints

This parameter is used to set the gain and bias of the **V/I** input terminal when the **V/I** terminal is used as the control input while operating in the **Speed Control** mode.

This parameter sets **V/I Input Point 1 Frequency** and is the frequency that is associated with the setting of **V/I Input Point 1 Setting** when operating in the **Speed Control** mode.

See **V/I Input Point 1 Setting** (F201) for more information on this setting.

Direct Access Number — F202Parameter Type — **Numerical**Factory Default — **0.00**Changeable During Run — **Yes**

Minimum — 0.00

Maximum — **Max. Freq. (F011)**

Units — Hz

V/I Input Point 2 Setting

Program ⇒ Frequency ⇒ Speed Reference Setpoints

This parameter is used to set the gain and bias of the **V/I** input terminal when the **V/I** terminal is used as the control input while operating in the **Speed Control** mode or the **Torque Control** mode.

This parameter sets the **V/I** input level that is associated with **V/I Input Point 2 Frequency** when operating in the **Speed** control mode or is associated with the **V/I Input Point 1 Rate** when operating in the **Torque Control** mode.

This value is entered as 0% to 100% of the **V/I** input signal range.

See **V/I Input Point 1 Setting** (F201) for more information on this setting when used for **Speed** control.

See **V/I Input Point 1 Rate** (F203) for more information on this setting when used for **Torque Control**.

Direct Access Number — F203Parameter Type — **Numerical**Factory Default — **100**Changeable During Run — **Yes**

Minimum — 0

Maximum — 100

Units — %

V/I Input Point 2 Frequency

Program ⇒ Frequency ⇒ Speed Reference Setpoints

This parameter is used to set the gain and bias of the **V/I** input terminal when the **V/I** terminal is used as the control input while operating in the **Speed Control** mode.

This parameter sets **V/I Input Point 2 Frequency** and is the frequency that is associated with the setting of **V/I Input Point 2 Setting** when operating in the **Speed Control** mode.

See **V/I Input Point 1 Setting** (F201) for more information on this setting.

Direct Access Number — F204Parameter Type — **Numerical**Factory Default — **60.00**Changeable During Run — **Yes**

Minimum — 0.00

Maximum — **Max. Freq. (F011)**

Units — Hz

V/I Input Point 1 Rate

Program ⇒ Torque ⇒ Setpoints

This parameter is used to set the gain and bias of the isolated V/I input terminal when the V/I terminal is used as the control input while operating in the **Torque Control** mode.

V/I Input Torque Control Setup

Perform the following setup to allow the system to receive **Torque Control** input at the V/I input terminal:

- Set **SW301** of the **Terminal Board** to **Voltage** or **Current** (see [Figure 9](#) on [pg. 24](#)).
- Program ⇒ Fundamental ⇒ Standard Mode Selection ⇒ Frequency Mode 1 ⇒ **V/I**.
- Program ⇒ Fundamental ⇒ Standard Mode Selection ⇒ Command Mode Selection ⇒ **Terminal Block**.

Torque Control

Perform the following setup to allow the system to perform **Torque Control** from the V/I input terminal:

- Set **V/I Input Point 1 Rate** ([F205](#)).
- Set **V/I Input Point 1 Setting** ([F201](#)) — the input analog signal level that corresponds to the torque setting at **V/I Input Point 1 Rate**.
- Set **V/I Input Point 2 Rate** ([F206](#)).
- Set **V/I Input Point 2 Setting** ([F203](#)) — the input analog signal level that corresponds to the torque setting at **V/I Input Point 2 Rate**.
- Provide a **Run** command (**F** and/or **R**).

Torque Control is accomplished by establishing an associated V/f output pattern for a given V/I input level.

Once set, as the V/I input voltage changes or the V/I current changes, the output torque of the ASD will vary in accordance with the above settings.

This parameter sets **V/I Input Point 1 Rate** and is the output torque value that is associated with the setting of **V/I Input Point 1 Setting** when operating in the **Torque Control** mode.

This value is entered as 0% to 250% of the rated torque.

Note: When using the isolated V/I input terminal the **IICC** terminal must be used as the return (negative) connection.

Direct Access Number — F205

Parameter Type — Numerical

Factory Default — 0.00

Changeable During Run — Yes

Minimum — 0.00

Maximum — 250.00

Units — %

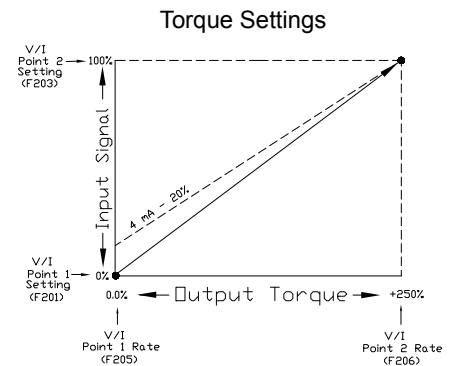

V/I Input Point 2 Rate

Program ⇒ Torque ⇒ Setpoints

This parameter is used to set the gain and bias of the V/I input terminal when the V/I terminal is used as the control input while operating in the **Torque Control** mode.

Torque Control is accomplished by establishing an associated V/f output pattern for a given V/I input level.

This parameter sets **V/I Input Point 2 Rate** and is the output torque value that is associated with the setting of **V/I Input Point 2 Setting** when operating in the **Torque Control** mode.

This value is entered as 0% to 250% of the rated torque.

See **V/I Input Point 1 Rate (F205)** for more information on this setting.

Direct Access Number — F206

Parameter Type — **Numerical**

Factory Default — **100.00**

Changeable During Run — **Yes**

Minimum — 0.00

Maximum — 250.00

Units — %

Frequency Mode 2

Program ⇒ Fundamental ⇒ Standard Mode Selection

This parameter is used to set the source of the frequency command signal to be used as **Frequency Mode 2** in the event that **Frequency Mode 1** is disabled or if **Frequency Mode 2** is set up as the primary control parameter.

See **F004** and **F200** for additional information on this setting.

Settings:

- 1 — V/I
- 2 — RR
- 3 — RX
- 4 — Not Used
- 5 — EOI (Keypad)
- 6 — RS485
- 7 — Communication Option Board
- 8 — RX2 Option (A11)
- 9 — Option V/I
- 10 — UP/DOWN Frequency (Terminal Board)
- 11 — Pulse Input (Option)
- 12 — Pulse Input (Motor CPU)
- 13 — Binary/BCD Input (Option)

Direct Access Number — F207

Parameter Type — **Selection List**

Factory Default — **V/I**

Changeable During Run — **Yes**

Frequency Mode Priority Switching Frequency

Program ⇒ Fundamental ⇒ Standard Mode Selection

This parameter establishes a threshold frequency that will be used as a reference when determining when to switch the output frequency control source from the **Frequency Mode 1** setting to the **Frequency Mode 2** setting.

See **F200** for additional information on this setting.

Direct Access Number — F208

Parameter Type — **Numerical**

Factory Default — **0.10**

Changeable During Run — **Yes**

Minimum — 0.10

Maximum — **Max. Freq. (F011)**

Units — Hz

Analog Input Filter

Program ⇒ Frequency ⇒ Analog Filter

Analog filtering is applied after the analog reference signal is converted to a digital signal. The type of filtering used is **Rolling Average** over time.

Settings:

- 0 — None (1 mS)
- 1 — Small (8 mS)
- 2 — Medium (16 mS)
- 3 — Large (32 mS)
- 4 — Huge (64 mS)

The analog input signal is sampled and converted to a digital signal. With no filtering applied, the resulting digital value is scaled for use by the microprocessor of the ASD.

If the filtering selection **Small** is selected, the ASD averages the last **8 mS** of sampled signal and converted (digital) values. The rolling average is updated (every 4 μ S) and scaled for use by the microprocessor.

This holds true for the **Medium**, **Large**, and **Huge** selections providing a larger sample to produce the average for use by the microprocessor.

False responses to electrical noise are eliminated with no loss in bandwidth because the value used by the drive is the average value of several samples.

Direct Access Number — F209Parameter Type — **Selection List**Factory Default — **None**Changeable During Run — **Yes**

RR Input Point 1 Setting

Program ⇒ Frequency ⇒ Speed Reference Setpoints

This parameter is used to set the gain and bias of the **RR** input terminal when the **RR** terminal is used as the control input while operating in the **Speed Control** mode or the **Torque Control** mode.

This parameter sets the **RR** input level that is associated with the **RR Input Point 1 Frequency** setting when operating in the **Speed** control mode or is associated with the **RR Input Point 1 Rate** setting when operating in the **Torque Control** mode.

Speed Control

Perform the following setup to allow the system to perform **Speed** control from the **RR** input terminal:

- Set **RR Input Point 1 Frequency** (F211).
- Set **RR Input Point 1 Setting** (F210) — the input analog signal level that corresponds to the frequency setting at **RR Input Point 1 Frequency**.
- Set **RR Input Point 2 Frequency** (F213).
- Set **RR Input Point 2 Setting** (F212) — the input analog signal level that corresponds to the frequency setting at **RR Input Point 2 Frequency**.

RR Input Speed Control Setup

Perform the following setup to allow the system to receive **Speed** control input at the **RR** input terminal:

- Program ⇒ Fundamental ⇒ Standard Mode Selection ⇒ Frequency Mode 1 ⇒ **RR**.
- Program ⇒ Fundamental ⇒ Standard Mode Selection ⇒ Command Mode Selection ⇒ **Terminal Block**.
- Provide a **Run** command (F and/or R).

Once set, as the **RR** input voltage changes, the output frequency of the ASD will vary in accordance with the above settings.

This parameter value is entered as 0% to 100% of the **RR** input signal range.

RR Input Point 1 Frequency

Program ⇒ Frequency ⇒ Speed Reference Setpoints

This parameter is used to set the gain and bias of the **RR** input terminal when the **RR** terminal is used as the control input while operating in the **Speed Control** mode.

This parameter sets **RR Input Point 1 Frequency** and is the frequency that is associated with the setting of **RR Input Point 1 Setting** when operating in the **Speed Control** mode.

See **RR Input Point 1 Setting** (F210) for more information on this setting.

Direct Access Number — F210

Parameter Type — Numerical

Factory Default — 0

Changeable During Run — Yes

Minimum — 0

Maximum — 100

Units — %

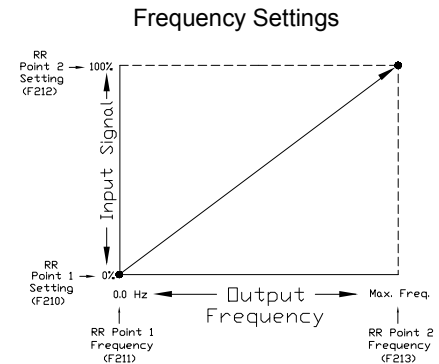

Direct Access Number — F211

Parameter Type — Numerical

Factory Default — 0.00

Changeable During Run — Yes

Minimum — 0.00

Maximum — **Max. Freq.** (F011)

Units — Hz

RR Input Point 2 Setting

Program ⇒ Frequency ⇒ Speed Reference Setpoints

This parameter is used to set the gain and bias of the **RR** input terminal when the **RR** terminal is used as the control input while operating in the **Speed Control** mode or the **Torque Control** mode.

This parameter sets the **RR** input level that is associated with **RR Input Point 2 Frequency** when operating in the **Speed** control mode or is associated with the **RR Input Point 1 Rate** when operating in the **Torque Control** mode.

This value is entered as 0% to 100% of the **RR** input signal range.

See **RR Input Point 1 Setting** (F210) for more information on this setting when used for **Speed** control.

See **RR Input Point 1 Rate** (F214) for more information on this setting when used for **Torque Control**.

Direct Access Number — F212Parameter Type — **Numerical**Factory Default — **100**Changeable During Run — **Yes**

Minimum — 0

Maximum — 100

Units — %

RR Input Point 2 Frequency

Program ⇒ Frequency ⇒ Speed Reference Setpoints

This parameter is used to set the gain and bias of the **RR** input terminal when the **RR** terminal is used as the control input while operating in the **Speed Control** mode.

This parameter sets **RR Input Point 2 Frequency** and is the frequency that is associated with the setting of **RR Input Point 2 Setting** when operating in the **Speed Control** mode.

See **RR Input Point 1 Setting** (F210) for more information on this setting.

Direct Access Number — F213Parameter Type — **Numerical**Factory Default — **60.00**Changeable During Run — **Yes**

Minimum — 0.00

Maximum — **Max. Freq. (F011)**

Units — Hz

RR Input Point 1 Rate

Program ⇒ Torque ⇒ Setpoints

This parameter is used to set the gain and bias of the **RR** input terminal when the **RR** terminal is used as the control input while operating in the **Torque Control** mode.

RR Input Torque Control Setup

Perform the following setup to allow the system to receive **Torque Control** input at the **RR** input terminal:

- Program ⇒ Fundamental ⇒ Standard Mode Selection ⇒ Frequency Mode ⇒ **RR**.
- Program ⇒ Fundamental ⇒ Standard Mode Selection ⇒ Command Mode Selection ⇒ **Terminal Block**.

Torque Control

Perform the following setup to allow the system to perform **Torque Control** from the **RR** input terminal:

- Set **RR Input Point 1 Rate** (F214).
- Set **RR Input Point 1 Setting** (F210) — the input analog signal level that corresponds to the torque setting at **RR Input Point 1 Rate**.
- Set **RR Input Point 2 Rate** (F215).
- Set **RR Input Point 2 Setting** (F212) — the input analog signal level that corresponds to the frequency setting at **RR Input Point 2 Rate**.
- Provide a **Run** command (F and/or R).

Torque Control is accomplished by establishing an associated **V/f** output pattern for a given **RR** input level.

Once set, as the **RR** input voltage changes, the output torque of the ASD will vary in accordance with the above settings.

This parameter sets **RR Input Point 1 Rate** and is the output torque value that is associated with the setting of **RR Input Point 1 Setting** when operating in the **Torque Control** mode.

This value is entered as 0% to 250% of the rated torque.

RR Input Point 2 Rate

Program ⇒ Torque ⇒ Setpoints

This parameter is used to set the gain and bias of the **RR** input terminal when the **RR** terminal is used as the control input while operating in the **Torque Control** mode.

Torque Control is accomplished by establishing an associated **V/f** output pattern for a given **RR** input level.

This parameter sets **RR Input Point 2 Rate** and is the output torque value that is associated with the setting of **RR Input Point 2 Setting** when operating in the **Torque Control** mode.

This value is entered as 0% to 250% of the rated torque.

See **RR Input Point 1 Rate** (F214) for more information on this setting.

Direct Access Number — F214

Parameter Type — Numerical

Factory Default — 0.00

Changeable During Run — Yes

Minimum — 0.00

Maximum — 250.00

Units — %

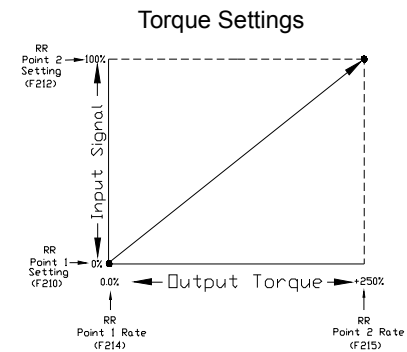

Direct Access Number — F215

Parameter Type — Numerical

Factory Default — 100.00

Changeable During Run — Yes

Minimum — 0.00

Maximum — 250.00

Units — %

RX Input Point 1 Setting

Program ⇒ Frequency ⇒ Speed Reference Setpoints

This parameter is used to set the gain and bias of the **RX** input terminal when the **RX** terminal is used as the control input while operating in the **Speed Control** mode or the **Torque Control** mode.

This parameter sets the **RX** input level that is associated with **RX Input Point 1 Frequency** when operating in the **Speed Control** mode or is associated with the **RX Input Point 1 Rate** when operating in the **Torque Control** mode.

RX Input Speed Control Setup

Perform the following setup to allow the system to receive **Speed** control input at the **RX** input terminal:

- Program ⇒ Fundamental ⇒ Standard Mode Selection ⇒ Frequency Mode 1 ⇒ **RX**.
- Program ⇒ Fundamental ⇒ Standard Mode Selection ⇒ Command Mode Selection ⇒ **Terminal Block**.

Speed Control

Perform the following setup to allow the system to perform **Speed** control from the **RX** input terminal:

- Set **RX Input Point 1 Frequency** (F217).
- Set **RX Input Point 1 Setting** (F216) — the input analog signal level that corresponds to the speed setting at **RX Input Point 1 Frequency**.
- Set **RX Input Point 2 Frequency** (F219).
- Set **RX Input Point 2 Setting** (F218) — the input analog signal level that corresponds to the speed setting at **RX Input Point 2 Frequency**.
- Provide a **Run** command (F and/or R).

Once set, as the **RX** input voltage changes, the ASD output speed and/or torque will vary in accordance with the above settings.

This parameter value is entered as -100% to +100% of the **RX** input signal range.

See parameter F474 and F475 for information on fine-tuning this terminal response.

Direct Access Number — F216

Parameter Type — Numerical

Factory Default — 0

Changeable During Run — Yes

Minimum — -100

Maximum — +100

Units — %

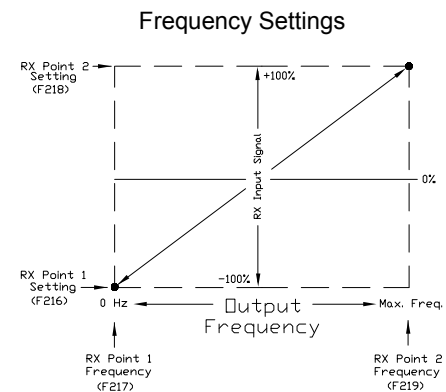

RX Input Point 1 Frequency

Program ⇒ Frequency ⇒ Speed Reference Setpoints

This parameter is used to set the gain and bias of the **RX** input terminal when the **RX** terminal is used as the control input while operating in the **Speed Control** mode.

This parameter sets **RX Input Point 1 Frequency** and is the frequency that is associated with the setting of **RX Input Point 1 Setting** when operating in the **Speed Control** mode.

See **RX Input Point 1 Setting** (F216) for more information on this setting.

Direct Access Number — F217

Parameter Type — Numerical

Factory Default — 0.00

Changeable During Run — Yes

Minimum — 0.00

Maximum — **Max. Freq.** (F011)

Units — Hz

RX Input Point 2 Setting

Program ⇒ Frequency ⇒ Speed Reference Setpoints

This parameter is used to set the gain and bias of the **RX** input terminal when the **RX** terminal is used as the control input while operating in the **Speed Control** mode or the **Torque Control** mode.

This parameter sets the **RX** input level that is associated with **RX Input Point 2 Frequency** when operating in the **Speed** control mode or is associated with the **RX Input Point 2 Rate** when operating in the **Torque Control** mode.

This value is entered as -100% to +100% of the **RX** input signal range.

See **RX Input Point 1 Setting** (F216) for more information on this setting when used for **Speed** control.

See **RX Input Point 1 Rate** (F220) for more information on this setting when used for **Torque Control**.

RX Input Point 2 Frequency

Program ⇒ Frequency ⇒ Speed Reference Setpoints

This parameter is used to set the gain and bias of the **RX** input terminal when the **RX** terminal is used as the control input while operating in the **Speed Control** mode.

This parameter sets **RX Input Point 2 Frequency** and is the frequency that is associated with the setting of **RX Input Point 2 Setting** when operating in the **Speed Control** mode.

See **RX Input Point 1 Setting** (F216) for more information on this setting.

Direct Access Number — F218Parameter Type — **Numerical**Factory Default — **+100**Changeable During Run — **Yes**

Minimum — -100.0

Maximum — +100.0

Units — %

Direct Access Number — F219Parameter Type — **Numerical**Factory Default — **60.00**Changeable During Run — **Yes**

Minimum — 0.00.

Maximum — **Max. Freq. (F011)**

Units — Hz

RX Input Point 1 Rate

Program ⇒ Torque ⇒ Setpoints

This parameter is used to set the gain and bias of the **RX** input terminal when the **RX** terminal is used as the control input while operating in the **Torque Control** mode.

RX Input Torque Control Setup

Perform the following setup to allow the system to receive **Torque Control** input at the **RX** input terminal:

- Program ⇒ Fundamental ⇒ Standard Mode Selection ⇒ Frequency Mode ⇒ **RX**.
- Program ⇒ Fundamental ⇒ Standard Mode Selection ⇒ Command Mode Selection ⇒ **Terminal Block**.

Torque Control

Perform the following setup to allow the system to perform **Torque Control** from the **RX** input terminal:

- Set **RX Input Point 1 Rate** (F220).
- Set **RX Input Point 1 Setting** (F216) — the input analog signal level that corresponds to the torque setting at **RX Input Point 1 Rate**.
- Set **RX Input Point 2 Rate** (F221).
- Set **RX Input Point 2 Setting** (F218) — the input analog signal level that corresponds to the speed setting at **RX Input Point 2 Rate**.
- Provide a **Run** command (F and/or R).

Torque Control is accomplished by establishing an associated **V/f** output pattern for a given **RX** input level.

Once set, as the **RX** input voltage changes, the ASD output speed and/or torque will vary in accordance with the above settings.

This parameter sets **RX Input Point 1 Rate** and is the output torque value that is associated with the setting of **RX Input Point 1 Setting** when operating in the **Torque Control** mode.

This value is entered as -250% to +250% of the rated torque.

Direct Access Number — F220

Parameter Type — Numerical

Factory Default — 0.00

Changeable During Run — Yes

Minimum — -250.00

Maximum — +250.00

Units — %

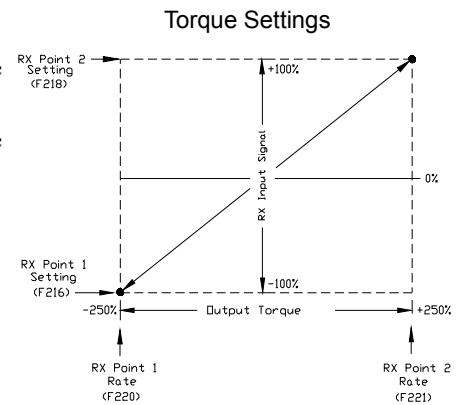

RX Input Point 2 Rate

Program ⇒ Torque ⇒ Setpoints

This parameter is used to set the gain and bias of the **RX** input terminal when the **RX** terminal is used as the control input while operating in the **Torque Control** mode.

Torque Control is accomplished by establishing an associated **V/f** output pattern for a given **RX** input level.

This parameter sets **RX Input Point 2 Rate** and is the output torque value that is associated with the setting of **RX Input Point 2 Setting** when operating in the **Torque Control** mode.

This value is entered as -250% to +250% of the rated torque.

See **RX Input Point 1 Rate** (F220) for more information on this setting.

Direct Access Number — F221

Parameter Type — Numerical

Factory Default — 0.00

Changeable During Run — Yes

Minimum — -250.00

Maximum — +250.00

Units — %

RX2 (AI1) Input Point 1 Setting

Program ⇒ Frequency ⇒ Speed Reference Setpoints

This parameter is used to set the gain and bias of the **RX2 (AI1)** input terminal when the **RX2 (AI1)** terminal is used as the control input while operating in the **Speed Control** mode or the **Torque Control** mode.

Note: *The Expansion IO Card Option 1 option board (P/N ETB003Z) is required to use this terminal.*

This parameter sets the **RX2 (AI1)** input level that is associated with **RX2 (AI1) Input Point 1 Frequency** when operating in the **Speed Control** mode or is associated with the **RX2 (AI1) Input Point 1 Rate** when operating in the **Torque Control** mode.

RX2 (AI1) Input Speed Control Setup

Perform the following setup to allow the system to receive **Speed** control input at the **RX2 (AI1)** input terminal:

- Program ⇒ Fundamental ⇒ Standard Mode Selection ⇒ Frequency Mode 1 ⇒ **RX2**.
- Program ⇒ Fundamental ⇒ Standard Mode Selection ⇒ Command Mode Selection ⇒ **Terminal Block**.

Speed Control

Perform the following setup to allow the system to perform **Speed** control from the **RX2 (AI1)** input terminal:

- Set **RX2 (AI1) Input Point 1 Frequency (F223)**.
- Set **RX2 (AI1) Input Point 1 Setting (F222)** — the input analog signal level that corresponds to the speed setting at **RX2 (AI1) Input Point 1 Frequency**.
- Set **RX2 (AI1) Input Point 2 Frequency (F225)**.
- Set **RX2 (AI1) Input Point 2 Setting (F224)** — the input analog signal level that corresponds to the speed setting at **RX Input Point 2 Frequency**.
- Provide a **Run** command (F and/or R).

Once set, as the **RX2 (AI1)** input voltage changes, the ASD output speed and/or torque will vary in accordance with the above settings.

This parameter value is entered as -100% to +100% of the **RX2 (AI1)** input signal range.

See the **Expansion IO Card Option 1** instruction manual (P/N 58685) for more information on the function of this terminal. See parameter [F476](#) and [F477](#) for information on fine-tuning this terminal response.

Direct Access Number — F222

Parameter Type — Numerical

Factory Default — 0

Changeable During Run — Yes

Minimum — -100

Maximum — +100

Units — %

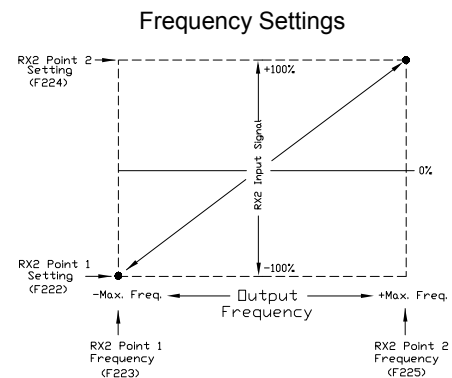

RX2 (AI1) Input Point 1 Frequency

Program ⇒ Frequency ⇒ Speed Reference Setpoints

This parameter is used to set the gain and bias of the **RX2 (AI1)** input terminal when the **RX2 (AI1)** terminal is used as the control input while operating in the **Speed Control** mode.

This parameter sets **RX2 (AI1) Input Point 1 Frequency** and is the frequency that is associated with the setting of **RX2 (AI1) Input Point 1 Setting** when operating in the **Speed Control** mode.

See **RX2 (AI1) Input Point 1 Setting (F222)** for more information on this setting.

Direct Access Number — F223Parameter Type — **Numerical**Factory Default — **0.00**Changeable During Run — **Yes**

Minimum — 0.00

Maximum — **Max. Freq. (F011)**

Units — Hz

RX2 (AI1) Input Point 2 Setting

Program ⇒ Frequency ⇒ Speed Reference Setpoints

This parameter is used to set the gain and bias of the **RX2 (AI1)** input terminal when the **RX2 (AI1)** terminal is used as the control input while operating in the **Speed Control** mode or the **Torque Control** mode.

This parameter sets the **RX2 (AI1)** input level that is associated with **RX2 (AI1) Input Point 2 Frequency** when operating in the **Speed** control mode or is associated with the **RX2 (AI1) Input Point 2 Rate** when operating in the **Torque Control** mode.

This value is entered as -100% to +100% of the **RX2 (AI1)** input signal range.

See **RX2 (AI1) Input Point 1 Setting (F222)** for more information on this setting when used for **Speed** control.

See **RX2 (AI1) Input Point 1 Rate (F226)** for more information on this setting when used for **Torque Control**.

Direct Access Number — F224Parameter Type — **Numerical**Factory Default — **+100**Changeable During Run — **Yes**

Minimum — -100

Maximum — +100

Units — %

RX2 (AI1) Input Point 2 Frequency

Program ⇒ Frequency ⇒ Speed Reference Setpoints

This parameter is used to set the gain and bias of the **RX2 (AI1)** input terminal when the **RX2 (AI1)** terminal is used as the control input while operating in the **Speed Control** mode.

This parameter sets **RX2 (AI1) Input Point 2 Frequency** and is the frequency that is associated with the setting of **RX2 (AI1) Input Point 2 Setting** when operating in the **Speed Control** mode.

See **RX2 (AI1) Input Point 1 Setting (F222)** for more information on this setting.

Direct Access Number — F225Parameter Type — **Numerical**Factory Default — **60.00**Changeable During Run — **Yes**

Minimum — 0.00

Maximum — **Max. Freq. (F011)**

Units — Hz

RX2 (AI1) Input Point 1 Rate

Program ⇒ Torque ⇒ Setpoints

This parameter is used to set the gain and bias of the **RX2 (AI1)** input terminal when the **RX2 (AI1)** terminal is used as the control input while operating in the **Torque Control** mode.

Note: The **Expansion IO Card Option 1** option board (P/N ETB003Z) is required to use this terminal.

RX2 (AI1) Input Torque Control Setup

Perform the following setup to allow the system to receive **Torque Control** input at the **RX2 (AI1)** input terminal:

- Program ⇒ Fundamental ⇒ Standard Mode Selection ⇒ Frequency Mode ⇒ **RX2**.
- Program ⇒ Fundamental ⇒ Standard Mode Selection ⇒ Command Mode Selection ⇒ **Terminal Block**.
- Provide a **Run** command (F and/or R).

Torque Control

Perform the following setup to allow the system to perform **Torque Control** from the **RX2 (AI1)** input terminal:

- Set **RX2 (AI1) Input Point 1 Rate** (F226).
- Set **RX2 (AI1) Input Point 1 Setting** (F222) — the input analog signal level that corresponds to the speed setting at **RX2 (AI1) Input Point 1 Rate**.
- Set **RX2 (AI1) Input Point 2 Rate** (F227).
- Set **RX2 (AI1) Input Point 2 Setting** (F224) — the input analog signal level that corresponds to the speed setting at **RX Input Point 2 Rate**.
- Provide a **Run** command (F and/or R).

Torque Control is accomplished by establishing an associated V/f output pattern for a given **RX2 (AI1)** input level.

Once set, as the **RX2 (AI1)** input voltage changes, the ASD output speed and/or torque will vary in accordance with the above settings.

This parameter sets **RX2 (AI1) Input Point 1 Rate** and is the output torque value that is associated with the setting of **RX2 (AI1) Input Point 1 Setting** when operating in the **Torque Control** mode.

This value is entered as -250% to +250% of the rated torque.

See the **Expansion IO Card Option 1** instruction manual (P/N 58685) for more information on the function of this terminal.

Direct Access Number — F226

Parameter Type — Numerical

Factory Default — 0.00

Changeable During Run — Yes

Minimum — -250.00

Maximum — +250.00

Units — %

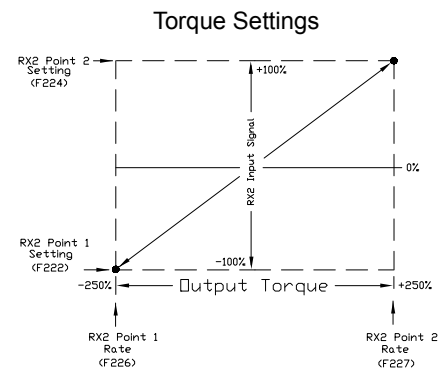

RX2 (AI1) Input Point 2 Rate

Program ⇒ Torque ⇒ Setpoints

This parameter is used to set the gain and bias of the **RX2 (AI1)** input terminal when the **RX2 (AI1)** terminal is used as the control input while operating in the **Torque Control** mode.

Torque Control is accomplished by establishing an associated **V/f** output pattern for a given **RX2 (AI1)** input level.

This parameter sets **RX2 (AI1) Input Point 2 Rate** and is the output torque value that is associated with the setting of **RX2 (AI1) Input Point 2 Setting** when operating in the **Torque Control** mode.

This value is entered as -250% to +250% of the rated torque.

See **RX2 (AI1) Input Point 1 Rate** ([F226](#)) for more information on this setting.

Direct Access Number — F227

Parameter Type — Numerical

Factory Default — 100.00

Changeable During Run — Yes

Minimum — -250.00

Maximum — +250.00

Units — %

BIN Input Point 1 Setting

Program ⇒ Frequency ⇒ Speed Reference Setpoints

This parameter is used to set the gain and bias of the **BIN** input terminals when the **BIN** terminals are used as the control input while operating in the **Speed Control** mode.

The discrete input terminals of the **Terminal Board** are used as the **BIN** terminals.

BIN Input Speed Control Setup

Perform the following setup to allow the system to receive **Speed** control input at the **BIN** input terminals:

- Program ⇒ Fundamental ⇒ Standard Mode Selection ⇒ Frequency Mode 1 ⇒ **Binary/BCD**.
- Program ⇒ Fundamental ⇒ Standard Mode Selection ⇒ Command Mode Selection ⇒ **Terminal Block**.
- Program ⇒ Terminal ⇒ **Input Terminals**; select and set the desired discrete input terminals to **Binary Bit(s) 0 – 7** (or 0 – MSB). The binary input byte will control the speed of the motor.
- Program ⇒ Terminal ⇒ **Input Terminals**; select and set a discrete input terminal to **Binary Data Write**. Activation of the **Binary Data Write** terminal will transfer the status of the **Binary Bit(s) 0 – 7** (or 0 – MSB) to the control board for speed control.

Speed Control

Perform the following setup to allow the system to perform **Speed** control from the **BIN** input terminals:

- Set **BIN Input Point 1 Frequency** (F229).
- Set the **BIN** input value (% of 255_D) (F228) that represents **BIN Input Point 1 Frequency**.
- Set **BIN Input Point 2 Frequency** (F231).
- Set the **BIN** input value (% of 255_D) (F230) that represents **BIN Input Point 2 Frequency**.
- Provide a **Run** command (F and/or R).

Note: 255_D is the decimal equivalent of the 8-bit BIN byte with all input terminals set to 1 (255 decimal = 11111111 binary).

Once set, as the **BIN** input signal changes are transferred to the control board, the output frequency of the ASD will vary in accordance with the above settings.

This parameter sets **BIN Input Point 1 Setting** and is entered as 0% to 100% of the of the range represented by the **BIN** binary input byte 11111111 (255_D) or the binary bit(s) 0 – MSB.

Direct Access Number — F228

Parameter Type — Numerical

Factory Default — 0

Changeable During Run — Yes

Minimum — 0

Maximum — 100

Units — %

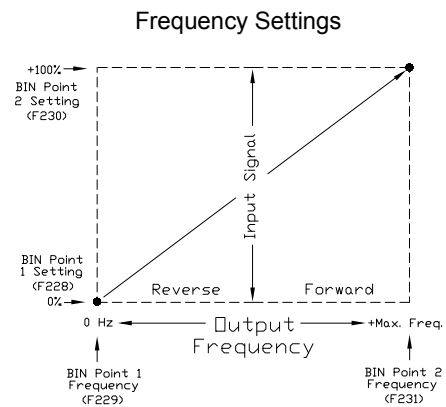

BIN Input Point 1 Frequency

Program ⇒ Frequency ⇒ Speed Reference Setpoints

This parameter is used to set the speed of the **BIN** input terminals when the **BIN** terminals are used as the control input.

This parameter sets **BIN Input Point 1 Frequency** and is the frequency that is associated with the setting of **BIN Input Point 1 Setting**.

See **BIN Input Point 1 Setting (F228)** for further information on this setting.

Direct Access Number — F229Parameter Type — **Numerical**Factory Default — **0.00**Changeable During Run — **Yes**

Minimum — 0

Maximum — **Max. Freq. (F011)**

Units — Hz

BIN Input Point 2 Setting

Program ⇒ Frequency ⇒ Speed Reference Setpoints

This parameter is used to set the speed of the **BIN** input terminals when the **BIN** terminals are used as the control input.

This parameter sets the **BIN** input signal that is associated with **BIN Input Point 2 Frequency**.

This value is entered as 0% to +100% of the **BIN** input signal range.

See **BIN Input Point 1 Setting (F228)** for further information on this setting.

Direct Access Number — F230Parameter Type — **Numerical**Factory Default — **100**Changeable During Run — **Yes**

Minimum — 0

Maximum — 100

Units — %

BIN Input Point 2 Frequency

Program ⇒ Frequency ⇒ Speed Reference Setpoints

This parameter is used to set the speed of the **BIN** input terminals when the **BIN** terminal are used as the control input.

This parameter sets **BIN Input Point 2 Frequency** and is the frequency that is associated with the setting of **BIN Input Point 2 Setting**.

See **BIN Input Point 1 Setting (F228)** for further information on this setting.

Direct Access Number — F231Parameter Type — **Numerical**Factory Default — **60.00**Changeable During Run — **Yes**

Maximum — 0.00

Maximum — **Max. Freq. (F011)**

Units — Hz

PG Input Point 1 Setting

Program ⇒ Frequency ⇒ Speed Reference Setpoints

This parameter is used to set the gain and bias of the **PG** input terminal of the option board when a shaft-mounted encoder is used as the control input while operating in the **Speed Control** mode.

Note: See *Instruction Manual P/N 58687* for more information on the **PG Option Board**.

PG Input Speed Control Setup

Perform the following setup to allow the system to receive **Speed** control input at the **PG** input terminal:

- Program ⇒ Fundamental ⇒ Standard Mode Selection ⇒ Frequency Mode 1 ⇒ **Pulse Input** (option).
- Program ⇒ Fundamental ⇒ Standard Mode Selection ⇒ **Command Mode Selection** ⇒ (any setting).
- Provide a **Run** command (F and/or R).

Speed Control

Perform the following setup to allow the system to perform **Speed** control from the **PG** input terminals:

- Set **PG Point 1 Frequency** (F235).
- Set the **PG** input value (F234) that represents **PG Point 1 Frequency**.
- Set **PG Point 2 Frequency** (F237).
- Set the **PG** input value (F236) that represents **PG Point 2 Frequency**.

Once set, as the **PG** input pulse count rate changes, the output frequency of the drive will vary in accordance with the above settings.

This parameter sets the **PG** input pulse count that represents **Reference Setpoint 1** (frequency). The range of values for this parameter is 0% to 100% of the **PG** input pulse count range.

Note: Further application-specific **PG** settings may be performed from the following path: Program ⇒ Feedback ⇒ **PG Settings**.

PG Input Point 1 Frequency

Program ⇒ Frequency ⇒ Speed Reference Setpoints

This parameter is used to set the speed of the **PG** input terminals when the **PG** terminal is used as the control input.

This parameter sets **PG Point 1 Frequency** and is the frequency that is associated with the setting of **PG Point 1 Setting**.

See **PG Point 1 Setting** (F234) for further information on this setting.

Direct Access Number — F234

Parameter Type — Numerical

Factory Default — 0.0

Changeable During Run — Yes

Minimum — 0

Maximum — 100.0

Units — %

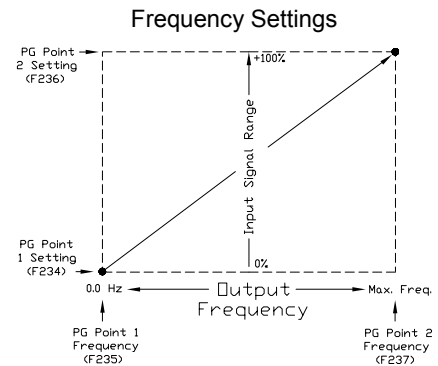

Direct Access Number — F235

Parameter Type — Numerical

Factory Default — 0.00

Changeable During Run — Yes

Minimum — 0.00

Maximum — Max. Freq. (F011)

Units — Hz

<p>PG Input Point 2 Setting</p> <p>Program ⇒ Frequency ⇒ Speed Reference Setpoints</p> <p>This parameter is used to set the direction and speed of the PG input terminals when the PG terminals are used as the control input.</p> <p>This parameter sets the PG input signal that is associated with PG Point 2 Frequency.</p> <p>This value is entered as 0% to 100% of the PG input signal range.</p> <p>See PG Point 1 Setting (F234) for further information on this setting.</p>	<p>Direct Access Number — F236</p> <p>Parameter Type — Numerical</p> <p>Factory Default — 0</p> <p>Changeable During Run — Yes</p> <p>Minimum — 0</p> <p>Maximum — 100</p> <p>Units — %</p>
<p>PG Input Point 2 Frequency</p> <p>Program ⇒ Frequency ⇒ Speed Reference Setpoints</p> <p>This parameter is used to set the direction and speed of the PG input terminals when the PG terminal are used as the control input.</p> <p>This parameter sets PG Point 2 Frequency and is the frequency that is associated with the setting of PG Point 2 Setting.</p> <p>See PG Point 1 Setting (F234) for further information on this setting.</p>	<p>Direct Access Number — F237</p> <p>Parameter Type — Numerical</p> <p>Factory Default — 60.00</p> <p>Changeable During Run — Yes</p> <p>Minimum — 0.00</p> <p>Maximum — Max. Freq. (F011)</p> <p>Units — Hz</p>
<p>Start Frequency</p> <p>Program ⇒ Special ⇒ Frequency Control</p> <p>The output of the drive will remain at 0.0 Hz until the programmed speed value exceeds this setting during startup. Once exceeded during startup, the output frequency of the drive will accelerate to the programmed setting.</p> <p>Output frequencies below the Start Frequency will not be output from the drive during startup. However, once reaching the Start Frequency, speed values below the Start Frequency may be output from the drive.</p> <p>If the setting of this parameter results in an over-current condition at startup, reduce the setting of this parameter to a value less than the rated slippage of the motor.</p> <p>If zero-speed torque is required, set this parameter and F243 to 0.0 Hz.</p> <p>This setting will override the setting of F244 if this setting has a higher value.</p> <p>This parameter setting is used during a Jog as the Lower-Limit Frequency (see F260).</p>	<p>Direct Access Number — F240</p> <p>Parameter Type — Numerical</p> <p>Factory Default — 0.10</p> <p>Changeable During Run — Yes</p> <p>Minimum — 0.00</p> <p>Maximum — Max. Freq. (F011)</p> <p>Units — Hz</p>
<p>Run Frequency</p> <p>Program ⇒ Special ⇒ Frequency Control</p> <p>This parameter establishes a center frequency (Run Frequency) of a frequency band.</p> <p>Parameter F242 provides a plus-or-minus value for the Run Frequency; thus, establishing a frequency band.</p> <p>During acceleration, the drive will not output a signal to the motor until the lower level of the band is reached.</p> <p>During deceleration, the drive will continue to output the programmed deceleration signal to the motor until the lower level of the band is reached; at which time the output will go to 0.0 Hz.</p>	<p>Direct Access Number — F241</p> <p>Parameter Type — Numerical</p> <p>Factory Default — 0.00</p> <p>Changeable During Run — Yes</p> <p>Minimum — 0.00</p> <p>Maximum — Max. Freq. (F011)</p> <p>Units — Hz</p>

Run Frequency Hysteresis

Program ⇒ Special ⇒ Frequency Control

This parameter provides a plus-or-minus value for the **Run Frequency** setting (F241).

Direct Access Number — F242Parameter Type — **Numerical**Factory Default — **0.00**Changeable During Run — **Yes**

Minimum — 0.00

Maximum — 30.0

Units — Hz

End Frequency

Program ⇒ Special ⇒ Frequency Control

This parameter sets the lowest frequency that the drive will recognize during deceleration before the drive goes to 0.0 Hz.

Direct Access Number — F243Parameter Type — **Numerical**Factory Default — **0.00**Changeable During Run — **Yes**

Minimum — 0.00

Maximum — 30.0

Units — Hz

0 Hz Dead Band Signal

Program ⇒ Special ⇒ Special Parameters

This parameter sets an output frequency threshold that, until the commanded frequency surpasses this setting, the ASD will output 0.0 Hz to the motor.

This setting will override the **Start Frequency** setting (F240) if this setting has a higher value.

Direct Access Number — F244Parameter Type — **Numerical**Factory Default — **0.00**Changeable During Run — **Yes**

Minimum — 0.00

Maximum — 5.00

Units — Hz

DC Injection Braking Start Frequency

Program ⇒ Protection ⇒ DC Braking

During deceleration this is the frequency at which **DC Injection Braking** will start.

DC Injection Braking

DC Injection Braking is a braking system used with 3-phase motors. Unlike conventional brakes, there is no physical contact between the rotating shaft and a stationary brake pad or drum. When braking is required, the drive outputs a DC current that is applied to the windings of the motor to quickly brake the motor. The braking current stops when the time entered in F252 times out.

The intensity of the DC current used while braking determines how fast the motor will come to a stop and may be set at F251. The intensity setting is entered as a percentage of the full load current of the ASD.

DC Injection Braking is also used to preheat the motor or to keep the rotor from spinning freely when the motor is off by providing a pulsating DC current into the motor at the **Carrier Frequency**. This feature may be enabled at F254.

Direct Access Number — F250Parameter Type — **Numerical**Factory Default — **0.00**Changeable During Run — **Yes**

Minimum — 0.00

Maximum — 120.00

Units — Hz

DC Injection Braking Current

Program ⇒ Protection ⇒ DC Braking

This parameter sets the percentage of the rated current of the drive that will be used for **DC Injection Braking**. A larger load will require a higher setting.

Direct Access Number — F251Parameter Type — **Numerical**Factory Default — **50**Changeable During Run — **Yes**

Minimum — 0

Maximum — 100

Units — %

<p>DC Injection Braking Time</p> <p>Program ⇒ Protection ⇒ DC Braking</p> <p>This parameter setting is used to set the on-time duration of the DC Injection Braking.</p>	<p>Direct Access Number — F252</p> <p>Parameter Type — Numerical</p> <p>Factory Default — 1.0</p> <p>Changeable During Run — Yes</p> <p>Minimum — 0.0</p> <p>Maximum — 20.0</p> <p>Units — Seconds</p>
<p>Forward/Reverse DC Injection Braking Priority</p> <p>Program ⇒ Protection ⇒ DC Braking</p> <p>This parameter setting determines if DC Injection Braking is to be used during a change in the direction of the motor.</p> <p>Settings:</p> <ul style="list-style-type: none"> 0 — Disabled 1 — Enabled 	<p>Direct Access Number — F253</p> <p>Parameter Type — Selection List</p> <p>Factory Default — Disabled</p> <p>Changeable During Run — Yes</p>
<p>Motor Shaft Fixing Control</p> <p>Program ⇒ Protection ⇒ DC Braking</p> <p>This parameter Enables/Disables a continuous DC injection at half of the amperage setting of F251 into a stopped motor. This feature is useful in preheating the motor or to keep the rotor from spinning freely.</p> <p>Motor Shaft Stationary Control starts after the DC injection brake stops the motor and continues until ST – CC is opened, power is turned off, an Emergency Off command is received, or this parameter is changed.</p> <p>Enabling this feature will also require a non-zero entry at F250.</p> <p>Settings:</p> <ul style="list-style-type: none"> 0 — Disabled 1 — Enabled 	<p>Direct Access Number — F254</p> <p>Parameter Type — Selection List</p> <p>Factory Default — Disabled</p> <p>Changeable During Run — Yes</p>
<p>0 Hz Command Output</p> <p>Program ⇒ Special ⇒ Special Parameters</p> <p>This parameter is used to set the go-to-zero method to be used by the ASD in the event that the ASD is commanded to go to zero Hz.</p> <p>Settings:</p> <ul style="list-style-type: none"> 0 — Standard (DC Injection Braking) 1 — 0 Hz Command 	<p>Direct Access Number — F255</p> <p>Parameter Type — Selection List</p> <p>Factory Default — Standard (DC Injection Braking)</p> <p>Changeable During Run — No</p>
<p>Time Limit For Lower-Limit Frequency Operation</p> <p>Program ⇒ Fundamental ⇒ Frequency Settings</p> <p>This parameter sets the time that the ASD is allowed to operate below the Lower-Limit setting before an alarm and subsequent fault is incurred.</p>	<p>Direct Access Number — F256</p> <p>Parameter Type — Numerical</p> <p>Factory Default — 0.0</p> <p>Changeable During Run — Yes</p> <p>Minimum — 0.0</p> <p>Maximum — 600.0</p> <p>Units — Seconds</p>

Jog Frequency

Program ⇒ Frequency ⇒ Jog Settings

This parameter sets the output frequency of the drive during a **Jog**. **Jog** is the term used to describe turning the motor on for small increments of time and is used when precise positioning of motor-driven equipment is required.

The **Jog** function may be initiated from the **EOI**, remotely via the **Terminal Board**, or using **Communications** (for more information on using Communications for Jogging, see the Communications manual P/N 53840).

The **Jog** function can be activated from zero Hz or from any frequency below the **Jog Run** frequency (Jog can only increase the speed). A **Jog** command will not be recognized when the running frequency is above the **Jog Run** frequency setting. The **Jog** command has priority over other **Run** commands and is not limited by the **Upper-Limit** setting of parameter **F012**.

Jog commands received while running for the opposite direction will follow the programmed stopping method of **F261** until reaching zero Hz and will then ramp to the programmed **Jog Frequency** and direction.

Jog Setup and Execution

To initiate a **Jog Run** from the **EOI** perform the following:

1. Enable the **Jog** function at **F262**.
2. Set the **Command Mode Selection (F003)** to **EOI** (Keypad).
3. Assign the **Jog Run** setting to a discrete input terminal (see [Table 5 on pg. 234](#)).

Note: Any unused discrete input terminal may be used for the **Jog Run** setting.

4. Set up a **Jog Stop Pattern** at **F261**.
5. Set the **Input Terminal Priority (F106)** function to **Disable** to receive **Jog** commands from the **EOI**.
6. Set the **Local/Remote** key to **Local**.
7. Activate the **Jog Run** terminal (from step 3) and provide a **Run** command (F or R).

Note: Simultaneous **F** and **R** activations will perform as setup at parameter **F105**.

8. Press the **Run** key and the ASD will output the frequency setting of **F260** for the duration of the activation.

To initiate a **Jog Run** from the **Terminal Board** perform the following:

1. Using the setup above, set the **Input Terminal Priority (F106)** function (from step 5) to **Enable** to receive **Jog** commands from the **Terminal Board** using the **Jog Run** terminal without regard to the **Local/Remote** setting.
2. Use the **Jog Run** terminal of step 3 above to activate the **Jog** function.

Direct Access Number — F260

Parameter Type — Numerical

Factory Default — 5.00

Changeable During Run — Yes

Minimum — F240 Setting

Maximum — 20.00

Units — Hz

Jog Stop Pattern

Program ⇒ Frequency ⇒ Jog Settings

This parameter sets the stopping method used while operating in the **Jog** mode.

***Note:** This parameter setting is used for the **Jog** operation only. The **Emergency Off** stopping method setting of parameter [F603](#) has priority over this setting and changes made here do not affect the function or setting of parameter [F603](#).*

Settings:

- 0 — Deceleration Stop
- 1 — Coast Stop
- 2 — DC Injection Braking Stop

Direct Access Number — F261Parameter Type — **Selection List**Factory Default — **Deceleration Stop**Changeable During Run — **Yes**

EOI (Panel) Operation Jog Mode

Program ⇒ Frequency ⇒ Jog Settings

This parameter enables the **Jog** command to be received from the **EOI**. When disabled the **Jog** command received from the **EOI** is ignored.

Jog commands may also be received from the **Terminal Board**. Priority as to which is allowed to override the other is selected at [F106](#).

The priority selection at [F106](#) enables the selected source for **Jog** control and disables the other. The [F106](#) setting overrides this parameter setting.

Settings:

- 0 — Disabled
- 1 — Enabled

Direct Access Number — F262Parameter Type — **Selection List**Factory Default — **Disabled**Changeable During Run — **Yes**

UP/DOWN Frequency (up) Response Time

No Path — Direct Access Only

This parameter functions in conjunction with the parameter settings of [F265](#), [F266](#), [F267](#), [F268](#), and [F269](#). The purpose of these settings is to setup the ASD to allow an externally-supplied discrete input signal to control the output frequency of the ASD.

This method uses the discrete input terminal settings **UP/DOWN Frequency (up)** and **UP/DOWN Frequency (down)** to change the ASD speed. Activation of either terminal increases or decreases the output frequency at the **Accel 1** or **Decel 1** rates, respectively.

Depending on the **Delay** setting, the **UP/DOWN Frequency (up/down)** terminal may perform **1)** the increase/decrease function for the duration of activation or **2)** the **UP/DOWN Frequency (up/down)** terminal may act as a momentary contact that loads a new commanded frequency upon activation.

In either case, to activate-and-hold will continue the up or down function until reaching the **Upper-Limit Frequency** or the **Lower-Limit Frequency**, respectively. At which point further activation will be ignored.

See [Figure 29](#) on pg. 130 for more information on the **UP/DOWN Frequency** function.

Setup Requirements

[F003](#) — Selects the **Command** control source; set to **Terminal Block**.

[F004](#) — Selects the **Frequency Control Mode 1** control source; set to **UP/DOWN Frequency**.

[F207](#) — Selects the **Frequency Control Mode 2** control source; set to **UP/DOWN Frequency** if used.

Set one unused discrete input terminal to **UP/DOWN Frequency (up)** and one unused discrete input terminal to **UP/DOWN Frequency (down)**.

[F264](#) — Sets the system-response delay to the initial activation of the discrete input terminal **UP/DOWN Frequency (up)**. Also sets the response delay of subsequent terminal activations of the **UP/DOWN Frequency (up)** terminal during an activate-and-hold.

[F265](#) — Sets the frequency increase amount for each activation of the **UP/DOWN Frequency (up)** terminal activation. The rate of the frequency increase is set at **Acceleration Time 1 (F009)**.

[F266](#) — Sets the system-response delay to the initial activation of the discrete input terminal **UP/DOWN Frequency (down)**. Also sets the activation delay of subsequent terminal activations of the **UP/DOWN Frequency (down)** terminal during an activate-and-hold.

[F267](#) — Sets the frequency decrease amount for each activation of the **UP/DOWN Frequency (down)** terminal activation. The rate of the frequency decrease is set at **Deceleration Time 1 (F010)**.

[F268](#) — At power up or after a reset, this parameter setting is used to provide a starting frequency for the **UP/DOWN Frequency** function.

[F269](#) — At power down while running, and when enabled, this parameter writes the running frequency into the [F268](#) location and, upon a system restart, uses this setting as the startup frequency.

Provide a **Run** command (F or R). The motor will run at the [F268](#) setting.

Direct Access Number — **F264**

Parameter Type — **Numerical**

Factory Default — **0.1**

Changeable During Run — **Yes**

Minimum — **0.0**

Maximum — **10.0**

Units — **Seconds**

Up/Down Frequency (up) Mode

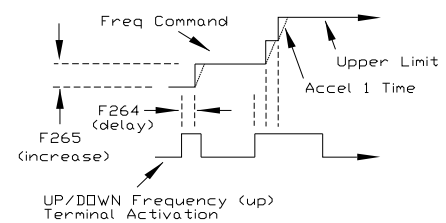

Up/Down Frequency (down) Mode

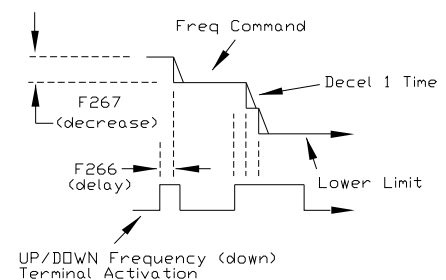

<p>UP/DOWN Frequency (up) Frequency Step</p> <p>No Path — Direct Access Only</p> <p>This parameter sets the frequency increase amount for each activation of the UP/DOWN Frequency (up) terminal activation. The rate of the frequency increase is set at Acceleration Time 1 (F009).</p> <p>See F264 for more information on this parameter.</p>	<p>Direct Access Number — F265</p> <p>Parameter Type — Numerical</p> <p>Factory Default — 0.10</p> <p>Changeable During Run — Yes</p> <p>Minimum — 0.00</p> <p>Maximum — Max. Freq. (F011)</p> <p>Units — Hz</p>
<p>UP/DOWN Frequency (down) Response Time</p> <p>No Path — Direct Access Only</p> <p>This parameter sets the system-response delay to the initial activation of the discrete input terminal UP/DOWN Frequency (down). Also sets the activation delay of subsequent terminal activations of the UP/DOWN Frequency (down) terminal during an activate-and-hold.</p> <p>See F264 for more information on this parameter.</p>	<p>Direct Access Number — F266</p> <p>Parameter Type — Numerical</p> <p>Factory Default — 0.1</p> <p>Changeable During Run — Yes</p> <p>Minimum — 0.0</p> <p>Maximum — 10.0</p> <p>Units — Seconds</p>
<p>UP/DOWN Frequency (down) Frequency Step</p> <p>No Path — Direct Access Only</p> <p>This parameter sets the frequency decrease amount for each activation of the UP/DOWN Frequency (down) terminal activation. The rate of the frequency decrease is set at Deceleration Time 1 (F010).</p> <p>See F264 for more information on this parameter.</p>	<p>Direct Access Number — F267</p> <p>Parameter Type — Numerical</p> <p>Factory Default — 0.10</p> <p>Changeable During Run — Yes</p> <p>Minimum — 0.00</p> <p>Maximum — Max. Freq. (F011)</p> <p>Units — Hz</p>
<p>Initial UP/DOWN Frequency</p> <p>No Path — Direct Access Only</p> <p>At power up or after a reset, this parameter setting is used to provide a starting frequency for the UP/DOWN Frequency function.</p> <p>See F269 for more information on this parameter setting.</p>	<p>Direct Access Number — F268</p> <p>Parameter Type — Numerical</p> <p>Factory Default — 0.00</p> <p>Changeable During Run — Yes</p> <p>Minimum — Lower-Limit (F013)</p> <p>Maximum — Upper-Limit (F012)</p> <p>Units — Hz</p>
<p>Initial UP/DOWN Frequency Rewriting</p> <p>No Path — Direct Access Only</p> <p>At power down, and when enabled, this parameter writes the running frequency into the F268 location and, upon a system restart, uses this setting as the startup frequency.</p> <p>Disable this parameter and set parameter F268 to the desired startup frequency if the same starting frequency is required at each startup.</p> <p><i>Note:</i> This parameter setting may be different at each startup when enabled.</p> <p>Settings:</p> <ul style="list-style-type: none"> 0 — Disabled 1 — Enabled (overwrite F268 at Power Off or Reset) 	<p>Direct Access Number — F269</p> <p>Parameter Type — Selection List</p> <p>Factory Default — Enabled</p> <p>Changeable During Run — Yes</p>

Figure 29. UP/Down Frequency Operation Control Timing Diagram.

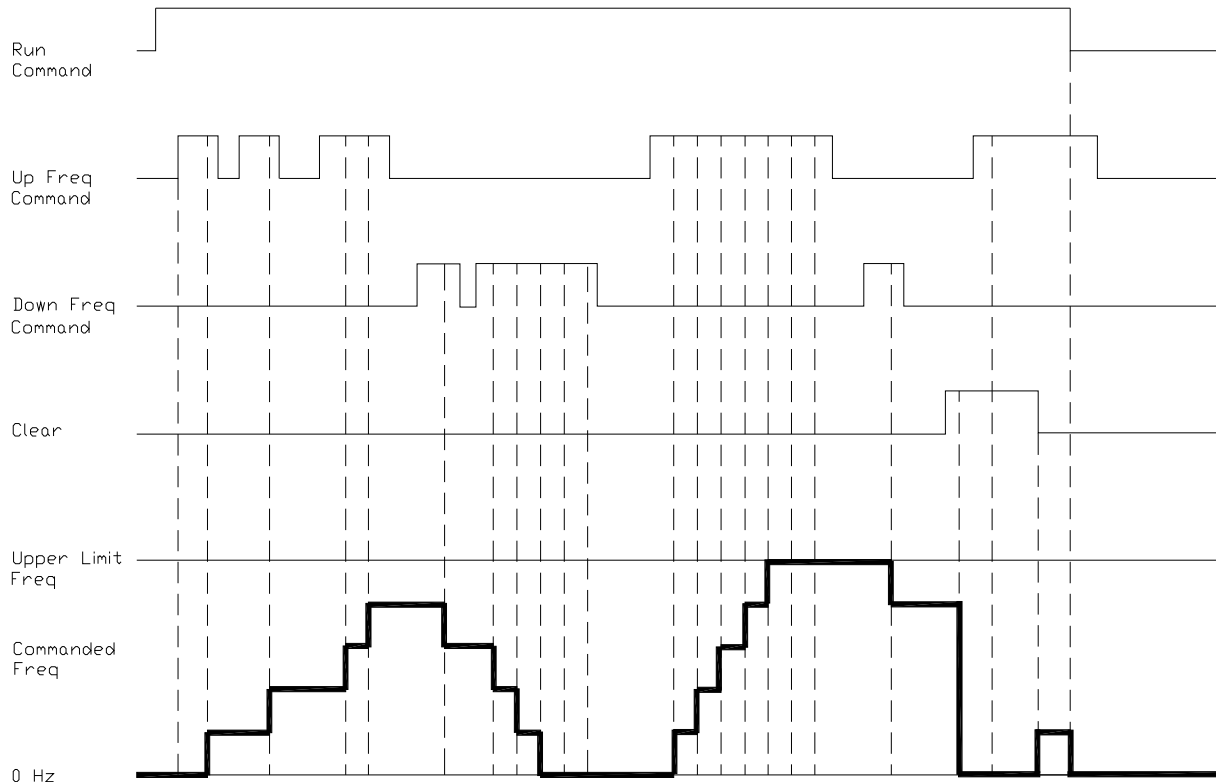

Jump Frequency 1

Program ⇒ Special ⇒ Jump Frequencies

In conjunction with parameter [F271](#), this parameter establishes a user-defined frequency range: the **Jump Frequency** and a plus-or-minus value.

During acceleration, the output frequency of the drive will hold at the lower level of the **Jump Frequency** range until the programmed acceleration ramp reaches the upper level of the **Jump Frequency** range. At which time the output frequency of the drive will accelerate to the upper level of the **Jump Frequency** range and continue upward as programmed.

During deceleration, the output frequency of the drive will hold at the upper level of the **Jump Frequency** range until the programmed deceleration ramp reaches the lower level of the **Jump Frequency** range. At which time the output frequency of the drive will decelerate to the lower level of the **Jump Frequency** range and continue downward as programmed.

Once set up and enabled, it is on in all control modes.

User-selected frequencies may be jumped to avoid the negative effects of mechanical resonance.

Direct Access Number — F270

Parameter Type — **Numerical**

Factory Default — **0.00**

Changeable During Run — **Yes**

Minimum — 0.00

Maximum — **Max. Freq. (F011)**

Units — Hz

<p>Jump Frequency 1 Bandwidth</p> <p>Program ⇒ Special ⇒ Jump Frequencies</p> <p>This parameter establishes a plus-or-minus value for Jump Frequency 1 (see F270).</p>	<p>Direct Access Number — F271</p> <p>Parameter Type — Numerical</p> <p>Factory Default — 0.00</p> <p>Changeable During Run — Yes</p> <p>Minimum — 0.00</p> <p>Maximum — 30.00</p> <p>Units — Hz</p>
<p>Jump Frequency 2</p> <p>Program ⇒ Special ⇒ Jump Frequencies</p> <p>Same as Jump Frequency 1 (F270) and is used when multiple frequencies are to be jumped (see the plus-or-minus value setting at F273). When multiple jump frequencies overlap, the system will recognize the lowest and the highest frequencies as one jump range.</p>	<p>Direct Access Number — F272</p> <p>Parameter Type — Numerical</p> <p>Factory Default — 0.00</p> <p>Changeable During Run — Yes</p> <p>Minimum — 0.00</p> <p>Maximum — Max. Freq. (F011)</p> <p>Units — Hz</p>
<p>Jump Frequency 2 Bandwidth</p> <p>Program ⇒ Special ⇒ Jump Frequencies</p> <p>This parameter establishes a plus-or-minus value for Jump Frequency 2 (F272).</p>	<p>Direct Access Number — F273</p> <p>Parameter Type — Numerical</p> <p>Factory Default — 0.00</p> <p>Changeable During Run — Yes</p> <p>Minimum — 0.00</p> <p>Maximum — 30.0</p> <p>Units — Hz</p>
<p>Jump Frequency 3</p> <p>Program ⇒ Special ⇒ Jump Frequencies</p> <p>Same as Jump Frequency 1 (F270) and is used when multiple frequencies are to be jumped (see the plus-or-minus value setting at F275).</p> <p>When multiple jump frequencies overlap, the system will recognize the lowest and the highest frequencies as one jump range.</p>	<p>Direct Access Number — F274</p> <p>Parameter Type — Numerical</p> <p>Factory Default — 0.00</p> <p>Changeable During Run — Yes</p> <p>Minimum — 0.00</p> <p>Maximum — Max. Freq. (F011)</p> <p>Units — Hz</p>
<p>Jump Frequency 3 Bandwidth</p> <p>Program ⇒ Special ⇒ Jump Frequencies</p> <p>This parameter establishes a plus-or-minus value for Jump Frequency 3 (F274).</p>	<p>Direct Access Number — F275</p> <p>Parameter Type — Numerical</p> <p>Factory Default — 0.00</p> <p>Changeable During Run — Yes</p> <p>Minimum — 0.00</p> <p>Maximum — 30.0</p> <p>Units — Hz</p>
<p>Preset Speed 8</p> <p>Program ⇒ Frequency ⇒ Preset Speeds</p> <p>This parameter assigns an output frequency to binary number 1000 and is identified as Preset Speed 8. The binary number is applied to S1 – S4 of the Terminal Board to output the Preset Speed (see F018 for more information on this parameter).</p>	<p>Direct Access Number — F287</p> <p>Parameter Type — Numerical</p> <p>Factory Default — 0.00</p> <p>Changeable During Run — Yes</p> <p>Minimum — Lower-Limit (F013)</p> <p>Maximum — Upper-Limit (F012)</p> <p>Units — Hz</p>

<p>Preset Speed 9</p> <p>Program ⇒ Frequency ⇒ Preset Speeds</p> <p>This parameter assigns an output frequency to binary number 1001 and is identified as Preset Speed 9. The binary number is applied to S1 – S4 of the Terminal Board to output the Preset Speed (see F018 for more information on this parameter).</p>	<p>Direct Access Number — F288</p> <p>Parameter Type — Numerical</p> <p>Factory Default — 0.0</p> <p>Changeable During Run — Yes</p> <p>Minimum — Lower-Limit (F013)</p> <p>Maximum — Upper-Limit (F012)</p> <p>Units — Hz</p>
<p>Preset Speed 10</p> <p>Program ⇒ Frequency ⇒ Preset Speeds</p> <p>This parameter assigns an output frequency to binary number 1010 and is identified as Preset Speed 10. The binary number is applied to S1 – S4 of the Terminal Board to output the Preset Speed (see F018 for more information on this parameter).</p>	<p>Direct Access Number — F289</p> <p>Parameter Type — Numerical</p> <p>Factory Default — 0.00</p> <p>Changeable During Run — Yes</p> <p>Minimum — Lower-Limit (F013)</p> <p>Maximum — Upper-Limit (F012)</p> <p>Units — Hz</p>
<p>Preset Speed 11</p> <p>Program ⇒ Frequency ⇒ Preset Speeds</p> <p>This parameter assigns an output frequency to binary number 1011 and is identified as Preset Speed 11. The binary number is applied to S1 – S4 of the Terminal Board to output the Preset Speed (see F018 for more information on this parameter).</p>	<p>Direct Access Number — F290</p> <p>Parameter Type — Numerical</p> <p>Factory Default — 0.00</p> <p>Changeable During Run — Yes</p> <p>Minimum — Lower-Limit (F013)</p> <p>Maximum — Upper-Limit (F012)</p> <p>Units — Hz</p>
<p>Preset Speed 12</p> <p>Program ⇒ Frequency ⇒ Preset Speeds</p> <p>This parameter assigns an output frequency to binary number 1100 and is identified as Preset Speed 12. The binary number is applied to S1 – S4 of the Terminal Board to output the Preset Speed (see F018 for more information on this parameter).</p>	<p>Direct Access Number — F291</p> <p>Parameter Type — Numerical</p> <p>Factory Default — 0.00</p> <p>Changeable During Run — Yes</p> <p>Minimum — Lower-Limit (F013)</p> <p>Maximum — Upper-Limit (F012)</p> <p>Units — Hz</p>
<p>Preset Speed 13</p> <p>Program ⇒ Frequency ⇒ Preset Speeds</p> <p>This parameter assigns an output frequency to binary number 1101 and is identified as Preset Speed 13. The binary number is applied to S1 – S4 of the Terminal Board to output the Preset Speed (see F018 for more information on this parameter).</p>	<p>Direct Access Number — F292</p> <p>Parameter Type — Numerical</p> <p>Factory Default — 0.00</p> <p>Changeable During Run — Yes</p> <p>Minimum — Lower-Limit (F013)</p> <p>Maximum — Upper-Limit (F012)</p> <p>Units — Hz</p>
<p>Preset Speed 14</p> <p>Program ⇒ Frequency ⇒ Preset Speeds</p> <p>This parameter assigns an output frequency to binary number 1110 and is identified as Preset Speed 14. The binary number is applied to S1 – S4 of the Terminal Board to output the Preset Speed (see F018 for more information on this parameter).</p>	<p>Direct Access Number — F293</p> <p>Parameter Type — Numerical</p> <p>Factory Default — 0.00</p> <p>Changeable During Run — Yes</p> <p>Minimum — Lower-Limit (F013)</p> <p>Maximum — Upper-Limit (F012)</p> <p>Units — Hz</p>

Preset Speed 15

Program ⇒ Frequency ⇒ Preset Speeds

This parameter assigns an output frequency to binary number 1111 and is identified as **Preset Speed 15**. The binary number is applied to **S1 – S4** of the **Terminal Board** to output the **Preset Speed** (see **F018** for more information on this parameter).

Direct Access Number — F294Parameter Type — **Numerical**Factory Default — **0.00**Changeable During Run — **Yes**Minimum — **Lower-Limit (F013)**Maximum — **Upper-Limit (F012)**

Units — Hz

PWM Carrier Frequency

Program ⇒ Special ⇒ Carrier Frequency

This parameter sets the frequency of the pulse width modulation signal applied to the motor.

Note: *When operating in the **Vector Control** mode the carrier frequency should be set to 2.2 kHz or above.*

Note: *If the PWM carrier frequency is set at 2.0 kHz or above, it cannot be decreased below 2.0 kHz while running. If the PWM carrier frequency is set at 1.9 kHz or below, it cannot be increased above 2.0 kHz while running. Either change requires that the ASD be stopped and restarted for the changes to take effect.*

Direct Access Number — F300Parameter Type — **Numerical**Factory Default — **2.200**Changeable During Run — **No**

Minimum — 1.0

Maximum — **(ASD-Dependent)**

Units — kHz

Auto Restart Selection

Program ⇒ Protection ⇒ Retry/Restart

This parameter **Enables/Disables** the ability of the drive to start into a spinning motor when the **ST – CC** connection opens momentarily and is then closed (Break/Make ST) or after a power interruption (momentary power failure).

Settings:

- 0 — Off
- 1 — Enabled (at Power Failure)
- 2 — Enabled (at Make-Break ST-CC)
- 3 — Enabled (at Make-Break ST-CC or Power Failure)
- 4 — Enabled (at Run)

Direct Access Number — F301Parameter Type — **Selection List**Factory Default — **Off**Changeable During Run — **No**

Regenerative Power Ridethrough Mode

Program ⇒ Protection ⇒ Under-Voltage/Ridethrough

This parameter determines the motor control response of the drive in the event of a momentary power outage or under-voltage condition.

During a **Ridethrough**, regenerative energy is used to maintain the control circuitry settings for the duration of the **Ridethrough**; it is not used to drive the motor. The motor(s) of the system are stopped and then restarted automatically if so configured.

In a multiple-motor application, there will be a requirement to synchronize the stopping and restarting of the motors as not to cause breakage in the product being processed by the motors stopping/starting at different times (e.g., wire spools, bobbin winder for textile machines, etc.). Parameters [F317](#) and [F318](#) must be setup to synchronize motor operation as to avoid breakage in these types of applications.

Note: *If used to restart the motors, the Retry setup of [F301](#) is required.*

Note: *The Jog function will not operate while in the **Synchronized Decel/Accel** mode.*

Settings:

- 0 — Off
- 1 — Ridethrough On
- 2 — Decel Stop
- 3 — Synchronized ACC/DEC (TB)
- 4 — Synchronized ACC/DEC (TB + Power Off)

Ridethrough Setup Requirements

1. Select the **Ridethrough Mode** at [F302](#).
2. Select the **Ridethrough Time** at [F310](#).
3. Select the **Synchronized Stop/Start Times** at [F317/F318](#) (if required).

Note: *[F317](#) and [F318](#) are not functional while operating in the **Torque** or **Position** control modes, or for the **Jog Run** function ([F260](#)).*

4. Set a discrete input terminal to **Power Failure Synchronized Signal** and activate the terminal to enable the **Synchronized Accel/Decel** function.
5. Select the **Ridethrough Control Level** at [F629](#).

Direct Access Number — [F302](#)

Parameter Type — **Selection List**

Factory Default — **Off**

Changeable During Run — **Yes**

Retry Selection

Program ⇒ Protection ⇒ Retry/Restart

After a trip has occurred, this parameter sets the number of times that an automatic system restart is attempted for a qualified trip.

The trip conditions listed below will not initiate the automatic **Retry/Restart** function:

- Input Phase Loss (Input Phase Failure)
- Output Phase Loss (Output Phase Failure)
- Output Current Protection Fault
- Output Current Detector Error
- Load Side Over-Current at Start
- Earth Fault (Ground Fault)
- Over-Current During Acceleration
- Arm Over-Current at Start-Up
- DBR Resistor Over-Current
- Low-Current
- Voltage Drop In Main Circuit
- EEPROM Data Fault (EEPROM Fault)
- Flash Memory/Gate Array/RAM-ROM Fault
- CPU Fault
- Emergency Off (EMG)
- Communication Error
- Option Fault
- Sink/Source Setting Error
- Over-Speed Error
- Over-Torque
- Key Error
- External Thermal Error
- Externally-Controlled Interrupt

See the section titled [System Setup Requirements on pg. 8](#) for more information on this setting.

Direct Access Number — F303

Parameter Type — **Numerical**

Factory Default — **00**

Changeable During Run — **Yes**

Minimum — 00

Maximum — 10

Dynamic Braking

Program ⇒ Protection ⇒ Dynamic Braking

This parameter **Enables/Disables** the **Dynamic Braking** system.

Settings:

- 0 — Off
- 1 — On with Overload Detection
- 2 — On without Overload Detection

Dynamic Braking uses the transistor **IGBT7** to dissipate the bus voltage when required.

IGBT7 is a standard item on the 25 HP and below H9 ASD 230-volt systems and is standard on the 400 HP and below for the for the 460-volt systems.

IGBT7 is optional for all remaining systems.

Dynamic Braking

Dynamic Braking is used to prevent over-voltage faults during rapid deceleration or constant speed run on cyclic overhauling applications.

Dynamic Braking dissipates regenerated energy in the form of heat. When using a DBR use thermal protection.

The resistive load is connected across terminals **PA** and **PB** (non-polarized). Using a low-value, high-wattage resistance as a load for the generated current, the resistive load dissipates the induced energy.

Dynamic Braking helps to slow the load quickly; it cannot act as a holding brake.

The **Dynamic Braking** function may be setup and enabled by connecting a braking resistor from terminal **PA** to **PB** of the drive and providing the proper information at [F304](#), [F308](#), and [F309](#).

See the section titled [Dynamic Braking System Specifications on pg. 266](#) for more information on using the DBR system and for assistance in selecting the appropriate resistor for a given application.

Direct Access Number — F304

Parameter Type — Selection List

Factory Default — Off

Changeable During Run — No

Over-Voltage Limit Operation

Program ⇒ Protection ⇒ Stall

This parameter enables the **Over-Voltage Limit** function. This feature is used to set the upper DC bus voltage threshold that, once exceeded, will cause an **Over-Voltage Stall**.

An **Over-Voltage Stall** increases the output frequency of the drive during deceleration for a specified time in an attempt to prevent an **Over-Voltage Trip**.

If the over-voltage threshold level setting of parameter [F626](#) is exceeded for over 4 mS, an **Over-Voltage Trip** will be incurred.

***Note:** This parameter setting may increase deceleration times.*

Settings:

- 0 — Enabled (Over-voltage Stall)
- 1 — Disabled
- 2 — Enabled (Forced Shorted Deceleration)
- 3 — Enabled (Forced Dynamic Braking Deceleration)

Direct Access Number — F305

Parameter Type — Selection List

Factory Default — (ASD-Dependent)

Changeable During Run — Yes

Supply Voltage Correction

Program ⇒ Protection ⇒ Base Frequency Voltage

This parameter **Enables/Disables** the **Voltage Compensation** function.When **Enabled**, this function provides a constant V/f ratio during periods of input voltage fluctuations.

Settings:

- 0 — Disabled (Output Voltage Unlimited)
- 1 — Enabled (Supply Voltage Compensation)
- 2 — Disabled (Output Voltage Limited)
- 3 — Enabled (Supply Voltage Compensation w/Output Voltage Limited)

Direct Access Number — F307Parameter Type — **Selection List**Factory Default — **Disabled**Changeable During Run — **No**

Dynamic Braking Resistance

Program ⇒ Protection ⇒ Dynamic Braking

This parameter is used to input the resistive value of the **Dynamic Braking Resistor** being used.Light-duty and heavy-duty resistors vary from a few ohms to several hundred ohms. The appropriate resistance size will be typeform- and application-specific.See the section titled [Dynamic Braking System Specifications on pg. 266](#) for more information on using the DBR system and for assistance in selecting the appropriate resistor for a given application.***Note:** Using a resistor value that is too low may result in system damage.***Direct Access Number** — F308Parameter Type — **Numerical**Factory Default — **(ASD-Dependent)**Changeable During Run — **No**

Minimum — 0.5

Maximum — 1000.0

Units — Ω

Continuous Dynamic Braking Capacity

Program ⇒ Protection ⇒ Dynamic Braking

This parameter is used to input the wattage of the **Dynamic Braking Resistor**.See the section titled [Dynamic Braking System Specifications on pg. 266](#) for more information on using the DBR system.***Note:** Using a resistor with a wattage rating that is too low may result in system damage.***Direct Access Number** — F309Parameter Type — **Numerical**Factory Default — **(ASD-Dependent)**Changeable During Run — **No**

Minimum — 0.01

Maximum — 600.00

Units — kW

Ridethrough Time

Program ⇒ Protection ⇒ Retry/Restart

In the event of a momentary power outage, this parameter determines the length of the **Ridethrough** time.The **Ridethrough** will be maintained for the number of seconds set using this parameter.See parameter [F302](#) for more information on the Ridethrough function.***Note:** The actual **Ridethrough Time** is load-dependent.***Direct Access Number** — F310Parameter Type — **Numerical**Factory Default — **2.0**Changeable During Run — **Yes**

Minimum — 0.1

Maximum — 320.0

Units — Seconds

Forward Run/Reverse Run Disable

Program ⇒ Frequency ⇒ Forward/Reverse Disable

This parameter **Enables/Disables** the **Forward Run** or **Reverse Run** mode.

If either direction is disabled, commands received for the disabled direction will not be recognized.

If both directions are disabled, the received direction command will determine the direction of the motor rotation.

Settings:

- 0 — Off
- 1 — Disable Reverse Run
- 2 — Disable Forward Run

Direct Access Number — F311Parameter Type — **Selection List**Factory Default — **Off**Changeable During Run — **No**

Random Mode

Program ⇒ Protection ⇒ Retry/Restart

This parameter adjusts the carrier frequency randomly. This feature is effective in minimizing the negative effects of mechanical resonance.

Settings:

- 0 — Disabled
- 1 — Enabled

Direct Access Number — F312Parameter Type — **Selection List**Factory Default — **Disabled**Changeable During Run — **No**

Carrier Frequency Control Mode

Program ⇒ Special ⇒ Carrier Frequency

This parameter provides for the automatic decrease of the carrier frequency.

Select **1** to decrease the **Carrier Frequency** setting as a function of an increased current requirement.Selection **2** or **3** may also include an output voltage drop as a function of an increased current requirement. The **Carrier Frequency** should be set below 4 kHz.

Settings:

- 0 — No Decrease and No Limit
- 1 — Valid Decrease and No Limit
- 2 — No Decrease and Limit Small Pulse
- 4 — Valid Decrease and Limit Small Pulse

Direct Access Number — F316Parameter Type — **Selection List**Factory Default — **Valid Decrease and No Limit**Changeable During Run — **Yes**

Synchronized Deceleration Time

Program ⇒ Protection ⇒ Under-Voltage/Ridethrough

In the event that the **Ridethrough** function activates in a multiple-motor application it will be necessary to manage the stopping motors synchronously as not to damage the product being processed (e.g., wire spools, bobbin winder for textile machines, etc.).

This parameter is used to minimize the product breakage during a momentary power outage. This function stops multiple machines simultaneously or makes them reach their respective command frequencies simultaneously by regulating their deceleration times.

See parameter [F302](#) for more information on this setting.**Direct Access Number** — F317Parameter Type — **Numerical**Factory Default — **2.0**Changeable During Run — **Yes**

Minimum — 0.1

Maximum — 6000.0

Units — Seconds

Synchronized Acceleration Time

Program ⇒ Protection ⇒ Under-Voltage/Ridethrough

In the event that the **Ridethrough** function activates in a multiple-motor application it will be necessary to manage the accelerating motors synchronously as not to damage the product being processed (e.g., wire spools, bobbin winder for textile machines, etc.).

This parameter is used to minimize the product breakage during a momentary power outage. This function orchestrates the acceleration of multiple machines simultaneously or makes them reach their respective command frequencies simultaneously by regulating their acceleration times.

See parameter [F302](#) for more information on this setting.

Direct Access Number — F318Parameter Type — **Numerical**Factory Default — **2.0**Changeable During Run — **Yes**

Minimum — 0.10

Maximum — 6000

Units — Seconds

Drooping Gain

Program ⇒ Feedback ⇒ Drooping Control

This parameter sets the effective 100% output torque level while operating in the **Drooping Control** mode. This value is the upper torque limit of the motor being driven by a given ASD while operating in the **Drooping Control** mode.

Note: The maximum frequency output is not limited by the setting of [F011](#) while operating in the **Drooping Control** mode.

Drooping

Drooping Control, also called **Load Share**, is used to share the load among two or more mechanically coupled motors. Unlike **Stall**, which reduces the output frequency in order to limit the load once the load reaches a preset level, **Drooping** can decrease or increase the V/f setting of a motor to maintain a balance between the output torque levels of mechanically coupled motors.

Because of variances in gearboxes, sheaves, belts, motors, and since the speed of the motor is constrained by the mechanical system, one motor may experience more load than its counterpart and may become overloaded.

Drooping Control allows the overloaded motor to slow down, thus shedding load and encouraging a lightly-loaded motor to pick up the slack. The goal of **Drooping Control** is to have the same torque ratios for mechanically coupled motors.

Direct Access Number — F320Parameter Type — **Numerical**Factory Default — **0.0**Changeable During Run — **Yes**

Minimum — 0.00

Maximum — 100.0

Units — %

Speed at 0% Drooping Gain

Program ⇒ Feedback ⇒ Drooping Control

This parameter sets the motor speed when at the 0% output torque gain while operating in the **Drooping Control** mode. This function determines the lowest speed that **Drooping** will be in effect for motors that share the same load.

Direct Access Number — F321Parameter Type — **Numerical**Factory Default — **0.00**Changeable During Run — **Yes**

Minimum — 0.00

Maximum — 320.0

Units — Hz

Speed at F320 Drooping Gain

Program ⇒ Feedback ⇒ Drooping Control

This parameter sets the motor speed when at the 100% output torque gain while operating in the **Drooping Control** mode. This function determines the speed of the individual motors at the 100% **Drooping Gain** setting for motors that share the same load.

Direct Access Number — F322Parameter Type — **Numerical**Factory Default — **0.00**Changeable During Run — **Yes**

Minimum — 0.00

Maximum — 320.0

Units — Hz

Drooping Insensitive Torque

Program ⇒ Feedback ⇒ Drooping Control

This parameter defines a torque range in which the **Drooping Control** settings will be ignored and the programmed torque settings will be followed.

Direct Access Number — F323Parameter Type — **Numerical**Factory Default — **10.00**Changeable During Run — **Yes**

Minimum — 0.00

Maximum — 100.0

Units — %

Drooping Output Filter

Program ⇒ Feedback ⇒ Drooping Control

This parameter is used to set the rate of output change allowed when operating in the **Drooping Control** mode.

Jerky operation may be reduced by increasing this setting.

Direct Access Number — F324Parameter Type — **Numerical**Factory Default — **100.0**Changeable During Run — **Yes**

Minimum — 0.1

Maximum — 200.0

Units — Radians/Second

Light-Load High-Speed Operation

Program ⇒ Special ⇒ Crane/Hoist Settings

This parameter enables the **Light-Load High-Speed** function by selecting an operating mode. The **Light-Load High-Speed** function accelerates the output frequency of the ASD from the programmed speed to the setting established in [F330](#).

This parameter may be disabled.

Enabling the **Light-Load High-Speed** function requires that an operating mode be selected here, and that the criteria of parameters [F331](#) – [F333](#) be met.

Settings:

- 0 — Off
- 1 — Auto Speed (F-Motor: Up, R-Generator:Down)
- 2 — Auto Speed (F-Generator: Down, R-Motor:Up)
- 3 — [F330](#) Setting (F-Motor: Up, R-Generator:Down)
- 4 — [F330](#) Setting (F-Generator: Down, R-Motor:Up)

Direct Access Number — F328Parameter Type — **Selection List**Factory Default — **Off**Changeable During Run — **Yes**

Light-Load High-Speed Learning Function

Program ⇒ Special ⇒ Crane/Hoist Settings

The **Light-Load High-Speed** function accelerates the output frequency of the ASD from the programmed speed to the setting established in [F330](#) and is primarily used with **Crane/Hoist** functions.

During **Light-Load High-Speed** operation with this parameter enabled, parameters **Panel Torque Bias** ([F343](#)), **Creep Frequency** ([F346](#)), and the **Creep Time** ([F347](#)) are set to a standard set of light-load profile values. Application-specific adjustments may be required.

Note: *This function should be setup with a light load only.*

Settings:

- 0 — Off
- 1 — Forward/Reverse
- 2 — Forward Only

Direct Access Number — F329Parameter Type — **Selection List**Factory Default — **Off**Changeable During Run — **No**

<p>Automatic Light-Load High-Speed Operation Frequency</p> <p>Program ⇒ Special ⇒ Crane/Hoist Settings</p> <p>This parameter establishes the speed to which the ASD will ramp when operating in the Light-Load High-Speed mode.</p>	<p>Direct Access Number — F330</p> <p>Parameter Type — Numerical</p> <p>Factory Default — 60.00</p> <p>Changeable During Run — No</p> <p>Minimum — 30.00</p> <p>Maximum — Upper-Limit (F012)</p> <p>Units — Hz</p>
<p>Light-Load High-Speed Operation Switching Lower-Limit Frequency</p> <p>Program ⇒ Special ⇒ Crane/Hoist Settings</p> <p>This parameter sets an output frequency threshold that, once surpassed, allows the Light-Load High-Speed function to be used.</p> <p>The Light-Load High-Speed function may be used if the frequency threshold set at this parameter and the following conditions are met:</p> <ol style="list-style-type: none"> 1) Light-Load High-Speed Operation Enable is configured at F328. 2) The output torque is less than the setting established in F335 when reaching the frequency setting here. 	<p>Direct Access Number — F331</p> <p>Parameter Type — Numerical</p> <p>Factory Default — 40.00</p> <p>Changeable During Run — Yes</p> <p>Minimum — 30.0</p> <p>Maximum — Upper-Limit (F012)</p> <p>Units — Hz</p>
<p>Light-Load High-Speed Operation Load Wait Time</p> <p>Program ⇒ Special ⇒ Crane/Hoist Settings</p> <p>This parameter determines the length of time that the load requirement must meet the Light-Load High-Speed criteria before the Light-Load High-Speed Enable (F328) is recognized.</p> <p>Once recognized, the timer setting of F333 must expire to engage the Light-Load High-Speed function.</p>	<p>Direct Access Number — F332</p> <p>Parameter Type — Numerical</p> <p>Factory Default — 0.5</p> <p>Changeable During Run — Yes</p> <p>Minimum — 0.0</p> <p>Maximum — 10.0</p> <p>Units — Seconds</p>
<p>Light-Load High-Speed Operation Detection Time</p> <p>Program ⇒ Special ⇒ Crane/Hoist Settings</p> <p>After the time setting of F332 times out, this parameter determines the length of time that the Light-Load High-Speed criteria must be met until the Light-Load High-Speed function engages.</p>	<p>Direct Access Number — F333</p> <p>Parameter Type — Numerical</p> <p>Factory Default — 1.0</p> <p>Changeable During Run — Yes</p> <p>Minimum — 0.0</p> <p>Maximum — 10.0</p> <p>Units — Seconds</p>
<p>Light-Load High-Speed Operation Heavy-Load Detection Time</p> <p>Program ⇒ Special ⇒ Crane/Hoist Settings</p> <p>While operating in the Light-Load High-Speed mode, this parameter determines the length of time that a load exceeding the Light-Load High-Speed operation criteria may exist before the Light-Load High-Speed mode is terminated and normal operation resumes.</p>	<p>Direct Access Number — F334</p> <p>Parameter Type — Numerical</p> <p>Factory Default — 0.5</p> <p>Changeable During Run — Yes</p> <p>Minimum — 0.0</p> <p>Maximum — 10.0</p> <p>Units — Seconds</p>

<p>Switching Load Torque During Power Running</p> <p>Program ⇒ Special ⇒ Crane/Hoist Settings</p> <p>During power running, this parameter establishes the threshold torque level that is used to determine if the Light-Load High-Speed (F328) operation may engage or remain engaged if active.</p> <p>If the Light-Load High-Speed operation is terminated normal operation resumes.</p> <p><i>Note:</i> Power running may be during forward, reverse, acceleration, or deceleration, but not during regeneration.</p>	<p>Direct Access Number — F335</p> <p>Parameter Type — Numerical</p> <p>Factory Default — 50.00</p> <p>Changeable During Run — No</p> <p>Minimum — -250.00</p> <p>Maximum — +250.00</p> <p>Units — %</p>
<p>Heavy-Load Torque During Power Running</p> <p>Program ⇒ Special ⇒ Crane/Hoist Settings</p> <p>During power running, this parameter establishes the threshold torque level that is used to determine if the Light-Load High-Speed (F328) operation may engage or remain engaged if active.</p> <p>If the Light-Load High-Speed operation is terminated normal operation resumes.</p>	<p>Direct Access Number — F336</p> <p>Parameter Type — Numerical</p> <p>Factory Default — 100.00</p> <p>Changeable During Run — Yes</p> <p>Minimum — -250.00</p> <p>Maximum — +250.00</p> <p>Units — %</p>
<p>Heavy-Load Torque During Constant Power Running</p> <p>Program ⇒ Special ⇒ Crane/Hoist Settings</p> <p>During constant power running, this parameter establishes the threshold torque level that is used to determine if the Light-Load High-Speed (F328) operation may engage or remain engaged if active.</p> <p>If the Light-Load High-Speed operation is terminated normal operation resumes.</p>	<p>Direct Access Number — F337</p> <p>Parameter Type — Numerical</p> <p>Factory Default — 50.00</p> <p>Changeable During Run — Yes</p> <p>Minimum — -250.00</p> <p>Maximum — +250.00</p> <p>Units — %</p>
<p>Switching Load Torque During Regenerative Braking</p> <p>Program ⇒ Special ⇒ Crane/Hoist Settings</p> <p>During regenerative braking, this parameter establishes the threshold torque level that is used to determine if the Light-Load High-Speed (F328) operation may engage or remain engaged if active.</p> <p>If the Light-Load High-Speed operation is terminated normal operation resumes.</p>	<p>Direct Access Number — F338</p> <p>Parameter Type — Numerical</p> <p>Factory Default — 50.00</p> <p>Changeable During Run — Yes</p> <p>Minimum — -250.00</p> <p>Maximum — +250.00</p> <p>Units — %</p>
<p>Braking Mode Selection</p> <p>Program ⇒ Torque ⇒ Torque Control</p> <p>This parameter is primarily used with lifting systems to allow for enough torque to be produced after receiving a Run command before releasing the brake. Without this feature the load would drop for a period once the brake was released.</p> <p>This parameter enables this function by setting the system operating mode.</p> <p>Settings:</p> <ul style="list-style-type: none"> 0 — Disabled 1 — Forward Direction 2 — Reverse Direction 3 — Same Direction 	<p>Direct Access Number — F341</p> <p>Parameter Type — Selection List</p> <p>Factory Default — Disabled</p> <p>Changeable During Run — Yes</p>

Torque Bias Input Selection

Program ⇒ Torque ⇒ Torque Control

Once enabled at parameter F341, this parameter sets the source of the input signal that will set the torque level used to provide the **Braking Mode Selection** function of parameter F341.

Settings:

- 0 — Disabled
- 1 — V/I
- 2 — RR
- 3 — RX
- 4 — EOI (Keypad)
- 5 — RS485 2-Wire
- 6 — RS485 4-Wire
- 7 — Communication Option Board
- 8 — RX2 Option (A11)

Direct Access Number — F342Parameter Type — **Selection List**Factory Default — **Disabled**Changeable During Run — **Yes**

Panel Torque Bias

Program ⇒ Torque ⇒ Torque Control

Once enabled at parameter F341, this parameter establishes the torque bias setting to which the setting of F342 will either add to or subtract from to produce the final torque value used to carry out the **Braking Mode Selection** function of parameter F341.

Direct Access Number — F343Parameter Type — **Numerical**Factory Default — **100.00**Changeable During Run — **Yes**

Minimum — -250.00

Maximum — +250.00

Units — %

Panel Torque Gain

Program ⇒ Torque ⇒ Torque Control

Once enabled at parameter F341, this parameter sets the sensitivity of the torque control source selected at F342 for the **Braking Mode Selection** function of parameter F341.

Direct Access Number — F344Parameter Type — **Numerical**Factory Default — **100.00**Changeable During Run — **Yes**

Minimum — 0.00

Maximum — 100.00

Units — %

Release Time

Program ⇒ Torque ⇒ Torque Control

Once enabled at parameter F341, this parameter sets the time that the brake will hold after the requirements of the **Braking Mode Selection** function of parameter F341 have been met.

Direct Access Number — F345Parameter Type — **Numerical**Factory Default — **0.05**Changeable During Run — **Yes**

Minimum — 0.00

Maximum — 2.50

Units — Seconds

Creeping Frequency

Program ⇒ Torque ⇒ Torque Control

Once enabled at parameter F341, and while running, upon receiving a **Stop** command this parameter sets an output frequency to be provided for the duration of the time setting of parameter F347.

Direct Access Number — F346Parameter Type — **Numerical**Factory Default — **3.00**Changeable During Run — **Yes**

Minimum — F240 Setting

Maximum — 20.0

Units — Hz

Creeping Time

Program ⇒ Torque ⇒ Torque Control

Once the **Creep** function of [F346](#) is activated, this parameter determines the duration of activation of the **Creep** function.

Direct Access Number — F347Parameter Type — **Numerical**Factory Default — **0.10**Changeable During Run — **Yes**

Minimum — 0.0

Maximum — 2.50

Units — Seconds

Braking Time Learning Function

Program ⇒ Torque ⇒ Torque Control

This parameter is used to establish approximate settings for parameters [F343](#), [F345](#), [F346](#), and [F347](#).

Note: Setting this parameter should be done using a light load only.

Set this parameter to **Brake Signal Learning**. Provide a Run command. The aforementioned parameters will receive approximate values. Application-specific adjustments may be required when finished.

Settings:

0 — Disabled

1 — Enabled

Direct Access Number — F348Parameter Type — **Selection List**Factory Default — **Disabled**Changeable During Run — **Yes**

Accel/Decel Suspend

Program ⇒ Fundamental ⇒ Accel/Decel 1 Settings

To maintain a constant speed setting while running, this parameter may be used to suspend speed changes for a user-set length of time.

The **Accel/Decel Suspend** function is enabled by setting this parameter to either **Terminal Board Input** or to [F350 – F353](#).

Selecting **Terminal Board Input** at this parameter requires that a discrete input terminal be set to **Dwell Signal** (see [Table 5 on pg. 234](#) for a listing of available settings). Upon activation of the **Dwell Signal** terminal the output frequency remains at the at-activation speed for the duration of the activation. When deactivated the programmed accel or decel ramp resumes.

Selecting [F350 – F353](#) at this parameter requires that the acceleration and/or the deceleration **Suspend Frequency** and **Suspend Time** settings be completed at [F350](#), [F351](#), [F352](#), and [F353](#). Upon reaching the frequency setting of [F350](#) (Accel) or [F352](#) (Decel), the Accel/Decel ramp will cease and the output frequency will hold at the threshold frequency setting for the time setting of [F351](#) for acceleration or [F353](#) for deceleration.

Settings:

0 — Off

1 — [F350 – F353](#) Settings2 — Terminal Board Input

Direct Access Number — F349Parameter Type — **Selection List**Factory Default — **Off**Changeable During Run — **Yes**

<p>Acceleration Suspend Frequency</p> <p>Program ⇒ Fundamental ⇒ Accel/Decel 1 Settings</p> <p>When Enabled at F349, this parameter is used to set the frequency at which the Acceleration Suspend function will activate.</p> <p>During acceleration, this parameter sets the frequency at which acceleration will stop and the motor will run at the setting of this parameter for the time setting of F351.</p>	<p>Direct Access Number — F350</p> <p>Parameter Type — Numerical</p> <p>Factory Default — 0.00</p> <p>Changeable During Run — Yes</p> <p>Minimum — 0.00</p> <p>Maximum — Max. Freq. (F011)</p> <p>Units — Hz</p>
<p>Acceleration Suspend Time</p> <p>Program ⇒ Fundamental ⇒ Accel/Decel 1 Settings</p> <p>When Enabled at F349, this parameter is used to set the duration of activation of the Acceleration Suspend function when initiated by reaching the Acceleration Suspend Frequency setting (F350).</p> <p>Once this parameter times out the acceleration rate will resume from the point of suspension.</p>	<p>Direct Access Number — F351</p> <p>Parameter Type — Numerical</p> <p>Factory Default — 0.0</p> <p>Changeable During Run — Yes</p> <p>Minimum — 0.0</p> <p>Maximum — 10.0</p> <p>Units — Seconds</p>
<p>Deceleration Suspend Frequency</p> <p>Program ⇒ Fundamental ⇒ Accel/Decel 1 Settings</p> <p>When Enabled at F349, this parameter is used to set the frequency at which the Deceleration Suspend function will activate.</p> <p>During deceleration, this parameter sets the frequency at which deceleration will stop and the motor will run at the setting of this parameter for the time setting of F353.</p>	<p>Direct Access Number — F352</p> <p>Parameter Type — Numerical</p> <p>Factory Default — 0.00</p> <p>Changeable During Run — Yes</p> <p>Minimum — 0.00</p> <p>Maximum — Max. Freq. (F011)</p> <p>Units — Hz</p>
<p>Deceleration Suspend Time</p> <p>Program ⇒ Fundamental ⇒ Accel/Decel 1 Settings</p> <p>When Enabled at F349, this parameter is used to set the duration of activation of the Deceleration Suspend function when initiated by reaching the Deceleration Suspend Frequency setting (F352).</p> <p>Once this parameter times out the deceleration rate will resume from the point of suspension.</p>	<p>Direct Access Number — F353</p> <p>Parameter Type — Numerical</p> <p>Factory Default — 0.0</p> <p>Changeable During Run — Yes</p> <p>Minimum — 0.0</p> <p>Maximum — 10.0</p> <p>Units — Seconds</p>

Commercial Power/ASD Output Switching

Program ⇒ Terminal ⇒ Line Power Switching

This parameter **Enables/Disables** the **Commercial Power/ASD Output Switching** function.

When enabled, the system may be set up to discontinue using the output of the drive and to switch to the commercial power in the event that 1) a trip is incurred, 2) a user-set frequency is reached, or 3) if initiated by a discrete input terminal.

Once set up with the proper switching frequency and hold times, the system will switch to commercial power upon reaching the **F355** frequency criterion.

Switching may also be accomplished manually by activating the discrete input terminal **Commercial Power ASD Switching**. Terminal activation forces the ASD output speed to accelerate to the **F355** switching frequency, resulting in the ASD-to-commercial power switching.

Deactivation of the discrete input terminal starts the hold-time counter setting (**F356**) for ASD-to-commercial power switching. Once timed out the motor resumes normal commercial power operation.

Settings:

- 0 — Off
- 1 — Switch at Signal Input and Trip
- 2 — Switch at Signal Input with Switching Frequency
- 3 — Switch at Signal Input and Trip with Switching Frequency

Switching Setup Requirements

F354 — Enable the switching function.

F355 — Set the switching frequency.

F356 — (Speed) Hold -time before applying ASD output after the switching criteria has been met.

F357 — (Speed) Hold -time before applying commercial power after the switching criteria has been met.

F358 — (Speed) Hold -time of applying commercial power after the switching criteria has been met.

Set a discrete input terminal to **Commercial Power ASD Switching**.

Set **OUT1** and **OUT2** to **Commercial Power/ASD Switching 1** and **2**, respectively.

Note: Ensure that the switching directions are the same and that **F311** is set to **Permit All**.

Note: The **OUT1** and **OUT2** outputs assigned to **Commercial Power/ASD Switching Output** are used to actuate the re-routing contactors.

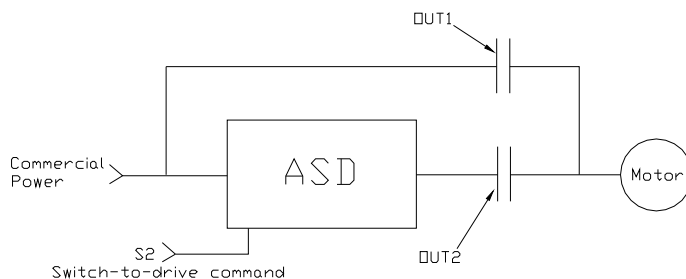

Direct Access Number — **F354**

Parameter Type — **Selection List**

Factory Default — **Off**

Changeable During Run — **No**

<p>Commercial Power/ASD Switching Frequency</p> <p>Program ⇒ Terminal ⇒ Line Power Switching</p> <p>When enabled at F354 and with a properly configured discrete output terminal, this parameter sets the frequency at which the At Frequency Powerline Switching function engages.</p> <p>The At Frequency Powerline Switching function commands the system to discontinue using the output of the drive and to switch to commercial power once reaching the frequency set here.</p> <p>See parameter F354 for more information on this setting.</p>	<p>Direct Access Number — F355</p> <p>Parameter Type — Numerical</p> <p>Factory Default — 60.00</p> <p>Changeable During Run — Yes</p> <p>Minimum — 0.00</p> <p>Maximum — Max. Freq. (F011)</p> <p>Units — Hz</p>
<p>ASD Side-Switching Wait Time</p> <p>Program ⇒ Terminal ⇒ Line Power Switching</p> <p>This parameter determines the amount of time that the drive will wait before outputting a signal to the motor once the switch-to-drive-output criteria has been met.</p> <p>See parameter F354 for more information on this setting.</p>	<p>Direct Access Number — F356</p> <p>Parameter Type — Numerical</p> <p>Factory Default — (ASD-Dependent)</p> <p>Changeable During Run — Yes</p> <p>Minimum — 0.10</p> <p>Maximum — 10.00</p> <p>Units — Seconds</p>
<p>Commercial Power Switching Wait Time</p> <p>Program ⇒ Terminal ⇒ Line Power Switching</p> <p>This parameter determines the amount of time that the drive will wait before allowing commercial power to be applied to the motor once the switch-to-commercial-power criteria has been met.</p> <p>See parameter F354 for more information on this setting.</p>	<p>Direct Access Number — F357</p> <p>Parameter Type — Numerical</p> <p>Factory Default — 0.62</p> <p>Changeable During Run — Yes</p> <p>Minimum — (ASD-Dependent)</p> <p>Maximum — 10.00</p> <p>Units — Seconds</p>
<p>Commercial Power Switching Freq. Hold Time</p> <p>Program ⇒ Terminal ⇒ Line Power Switching</p> <p>This parameter determines the amount of time that the connection to commercial power is maintained once the switch-to-drive-output criteria has been met.</p> <p>See parameter F354 for more information on this setting.</p>	<p>Direct Access Number — F358</p> <p>Parameter Type — Numerical</p> <p>Factory Default — 2.00</p> <p>Changeable During Run — Yes</p> <p>Minimum — 0.10</p> <p>Maximum — 10.00</p> <p>Units — Seconds</p>
<p>PID Control Switching</p> <p>Program ⇒ Feedback ⇒ Feedback Settings</p> <p>This parameter is used to set the PID control mode.</p> <p>Selecting Process PID uses the upper and lower-limit settings of parameters F367 and F368.</p> <p>Selecting Speed PID uses the upper and lower-limit settings of parameters F370 and F371.</p> <p>Settings:</p> <ul style="list-style-type: none"> 0 — PID Off 1 — Process PID 2 — Speed PID 3 — Easy Positioning PID (Not Used with the H9 ASD) 	<p>Direct Access Number — F359</p> <p>Parameter Type — Selection List</p> <p>Factory Default — PID Off</p> <p>Changeable During Run — No</p>

PID Feedback Signal

Program ⇒ Feedback ⇒ Feedback Settings

This parameter **Enables/Disables PID** feedback control. When enabled, this parameter determines the source of the motor control feedback.

Settings:

- 0 — PID Control Disabled
- 1 — V/I
- 2 — RR
- 3 — RX
- 4 — RX2 Option (A11)
- 5 — Option V/I (A12)
- 6 — PG Feedback Option

Proportional-Integral-Derivative (PID) — A closed-loop control technique that seeks error minimization by reacting to three values: One that is proportional to the error, one that is representative of the error, and one that is representative of the rate of change of the error.

PID Feedback Delay Filter

Program ⇒ Feedback ⇒ Feedback Settings

This parameter determines the delay in the ASD output response to the motor control feedback signal source is selected at [F360](#).

PID Feedback Proportional (P) Gain

Program ⇒ Feedback ⇒ Feedback Settings

This parameter determines the degree that the **Proportional** function affects the output signal. The larger the value entered here, the quicker the drive responds to changes in feedback.

PID Feedback Integral (I) Gain

Program ⇒ Feedback ⇒ Feedback Settings

This parameter determines the degree that the **Integral** function affects the output signal. The smaller the value here, the more pronounced the effect of the integral function on the output signal.

PID Deviation Upper-Limit

Program ⇒ Feedback ⇒ Feedback Settings

This parameter determines the maximum amount that the feedback may increase the output signal.

Direct Access Number — F360Parameter Type — **Selection List**Factory Default — **PID Control Disabled**Changeable During Run — **Yes**

Direct Access Number — F361Parameter Type — **Numerical**Factory Default — **0.1**Changeable During Run — **Yes**

Minimum — 0.0

Maximum — 25.0

Direct Access Number — F362Parameter Type — **Numerical**Factory Default — **0.10**Changeable During Run — **Yes**

Minimum — 0.01

Maximum — 100.0

Direct Access Number — F363Parameter Type — **Numerical**Factory Default — **0.10**Changeable During Run — **Yes**

Minimum — 0.01

Maximum — 100.00

Direct Access Number — F364Parameter Type — **Numerical**Factory Default — **60.00**Changeable During Run — **Yes**

Minimum — 0.00

Maximum — 60.00

Units — Hz

<p>PID Deviation Lower-Limit</p> <p>Program ⇒ Feedback ⇒ Feedback Settings</p> <p>This parameter determines the maximum amount that the feedback may decrease the output signal.</p>	<p>Direct Access Number — F365</p> <p>Parameter Type — Numerical</p> <p>Factory Default — 60.00</p> <p>Changeable During Run — Yes</p> <p>Minimum — 0.00</p> <p>Maximum — 60.00</p> <p>Units — Hz</p>
<p>PID Feedback Differential (D) Gain</p> <p>Program ⇒ Feedback ⇒ Feedback Settings</p> <p>This parameter determines the degree that the Differential function affects the output signal. The larger the value entered here, the more pronounced the affect of the differential function for a given feedback signal level.</p>	<p>Direct Access Number — F366</p> <p>Parameter Type — Numerical</p> <p>Factory Default — 0.00</p> <p>Changeable During Run — Yes</p> <p>Minimum — 0.00</p> <p>Maximum — 2.55</p>
<p>Process Upper-Limit</p> <p>Program ⇒ Feedback ⇒ Feedback Settings</p> <p>Selecting Process PID at parameter F359 allows for this parameter setting to function as the Upper-Limit while operating in the PID Control mode.</p>	<p>Direct Access Number — F367</p> <p>Parameter Type — Numerical</p> <p>Factory Default — 60.00</p> <p>Changeable During Run — No</p> <p>Minimum — Lower-Limit (F013)</p> <p>Maximum — Upper-Limit (F012)</p> <p>Units — Hz</p>
<p>Process Lower-Limit</p> <p>Program ⇒ Feedback ⇒ Feedback Settings</p> <p>Selecting Process PID at parameter F359 allows for this parameter setting to function as the Lower-Limit while operating in the PID Control mode.</p>	<p>Direct Access Number — F368</p> <p>Parameter Type — Numerical</p> <p>Factory Default — 0.00</p> <p>Changeable During Run — No</p> <p>Minimum — Lower-Limit (F013)</p> <p>Maximum — Upper-Limit (F012)</p> <p>Units — Hz</p>
<p>PID Control Wait Time</p> <p>Program ⇒ Feedback ⇒ Feedback Settings</p> <p>This parameter is used to delay the start of PID control at start up. During the wait time set here, the ASD will follow the frequency control input of the process value and the feedback input will be ignored until this setting times out. At which time the PID setup assumes control.</p>	<p>Direct Access Number — F369</p> <p>Parameter Type — Numerical</p> <p>Factory Default — 0</p> <p>Changeable During Run — Yes</p> <p>Minimum — 0</p> <p>Maximum — 2400</p> <p>Units — Seconds</p>
<p>PID Output Upper-Limit</p> <p>Program ⇒ Feedback ⇒ Feedback Settings</p> <p>Selecting Speed PID at parameter F359 allows for this parameter setting to function as the Upper-Limit while operating in the PID Control mode.</p>	<p>Direct Access Number — F370</p> <p>Parameter Type — Numerical</p> <p>Factory Default — 60.00</p> <p>Changeable During Run — No</p> <p>Minimum — Lower-Limit (F013)</p> <p>Maximum — Upper-Limit (F012)</p> <p>Units — Hz</p>

<p>PID Output Lower-Limit</p> <p>Program ⇒ Feedback ⇒ Feedback Settings</p> <p>Selecting Speed PID at parameter F359 allows for this parameter setting to function as the Lower-Limit while operating in the PID Control mode.</p>	<p>Direct Access Number — F371</p> <p>Parameter Type — Numerical</p> <p>Factory Default — 4.00</p> <p>Changeable During Run — Yes</p> <p>Minimum — Lower-Limit (F013)</p> <p>Maximum — Upper-Limit (F012)</p> <p>Units — Hz</p>
<p>Process Increasing Rate</p> <p>Program ⇒ Feedback ⇒ Feedback Settings</p> <p>This parameter is used to limit the rate that the output of the ASD may increase for a given difference in the speed reference and the PID feedback value.</p>	<p>Direct Access Number — F372</p> <p>Parameter Type — Numerical</p> <p>Factory Default — 10.0</p> <p>Changeable During Run — Yes</p> <p>Minimum — 0.1</p> <p>Maximum — 600.0</p> <p>Units — Seconds</p>
<p>Process Decreasing Rate</p> <p>Program ⇒ Feedback ⇒ Feedback Settings</p> <p>This parameter is used to limit the rate that the output of the ASD may decrease for a given difference in the speed reference and the PID feedback value.</p>	<p>Direct Access Number — F373</p> <p>Parameter Type — Numerical</p> <p>Factory Default — 10.0</p> <p>Changeable During Run — Yes</p> <p>Minimum — 0.1</p> <p>Maximum — 600.0</p> <p>Units — Seconds</p>
<p>Number of PG Input Pulses</p> <p>Program ⇒ Feedback ⇒ PG Settings</p> <p>This parameter is used to set the number of pulses output from a shaft-mounted encoder that is used to indicate one revolution of rotation (360°) of the motor or of the motor-driven equipment.</p>	<p>Direct Access Number — F375</p> <p>Parameter Type — Numerical</p> <p>Factory Default — (ASD-Dependent)</p> <p>Changeable During Run — No</p> <p>Minimum — 12</p> <p>Maximum — 9999</p>
<p>Number of PG Input Phases</p> <p>Program ⇒ Feedback ⇒ PG Settings</p> <p>This parameter determines the type of information that is supplied by the phase encoder.</p> <p>Settings:</p> <ul style="list-style-type: none"> 1 — Single Phase 2 — Two Phase 	<p>Direct Access Number — F376</p> <p>Parameter Type — Selection List</p> <p>Factory Default — (ASD-Dependent)</p> <p>Changeable During Run — Yes</p>

PG Disconnection Detection

Program ⇒ Feedback ⇒ PG Settings

This parameter **Enables/Disables** the system's monitoring of the PG connection status when using encoders with line driver outputs.

Note: The PG Vector Feedback Board option is required to use this feature.

Settings:

- 0 — Disabled
- 1 — Enabled with Filter
- 3 — Enabled (Detect momentary power fail)

Simple Positioning Completion Range

Program ⇒ Feedback ⇒ PG Settings

While operating in the **Positioning Control** mode, this parameter sets the range of accuracy for a **Stop** command initiated via the terminal board.

If the setting is too low the stop may be too abrupt.

Autotuning 1

Program ⇒ Motor ⇒ Vector Motor Model

This parameter sets the **Autotune** command status.

Selecting **Reset Motor Defaults** for this parameter sets parameters [F410](#), [F411](#), [F412](#), and [F413](#) to the factory default settings.

If selecting **Autotune on Run Command**, **Autotune Initiated by Input Terminal**, or **Autotune of Detail Parameters** for this parameter set the **Base Frequency**, **Base Frequency Voltage**, and the **Motor Rated Revolutions** to the nameplated values of the motor to achieve the best possible **Autotune** precision.

Settings:

- 0 — Autotune Disabled
- 1 — Reset Motor Defaults
- 2 — Enable Autotune on Run Command
- 3 — Autotuning by Input Terminal Signal (see [Table 5 on pg. 234](#))
- 4 — Motor Constant Auto Calculation

Slip Frequency Gain

Program ⇒ Motor ⇒ Vector Motor Model

This parameter provides a degree of slip compensation for a given load. A higher setting here decreases the slip allowed for a given load/ASD output ratio.

Direct Access Number — F377Parameter Type — **Selection List**Factory Default — **(ASD-Dependent)**Changeable During Run — **Yes**

Direct Access Number — F381Parameter Type — **Numerical**Factory Default — **100**Changeable During Run — **Yes**

Minimum — 1

Maximum — 4000

Direct Access Number — F400Parameter Type — **Selection List**Factory Default — **Autotune Disabled**Changeable During Run — **No**

Direct Access Number — F401Parameter Type — **Numerical**Factory Default — **70**Changeable During Run — **Yes**

Minimum — 0

Maximum — 150

Units — %

<p>Autotuning 2</p> <p>Program ⇒ Motor ⇒ Vector Motor Model</p> <p>This parameter introduces a thermal element into the autotuning equation and is used to automatically adjust the Autotune parameter values as a function of increases in the temperature of the motor.</p> <p>Settings:</p> <ul style="list-style-type: none"> 0 — Off 1 — Self-Cooled Motor Tuning 2 — Forced Air Cooled Motor Tuning 	<p>Direct Access Number — F402</p> <p>Parameter Type — Selection List</p> <p>Factory Default — Off</p> <p>Changeable During Run — No</p>
<p>Motor Rated Capacity</p> <p>Program ⇒ Motor ⇒ Vector Motor Model</p> <p>This parameter is used to set the (nameplated) rated capacity of the motor being used.</p>	<p>Direct Access Number — F405</p> <p>Parameter Type — Numerical</p> <p>Factory Default — 11.0</p> <p>Changeable During Run — Yes</p> <p>Minimum — 0.1</p> <p>Maximum — 500.00</p> <p>Units — kW</p>
<p>Motor Rated Current</p> <p>Program ⇒ Motor ⇒ Vector Motor Model</p> <p>This parameter is used to set the (nameplated) current rating of the motor being used.</p>	<p>Direct Access Number — F406</p> <p>Parameter Type — Numerical</p> <p>Factory Default — 20.3</p> <p>Changeable During Run — Yes</p> <p>Minimum — 0.1</p> <p>Maximum — 2000.0</p> <p>Units — Amps</p>
<p>Motor Rated RPM</p> <p>Program ⇒ Motor ⇒ Vector Motor Model</p> <p>This parameter is used input the (nameplated) rated speed of the motor.</p>	<p>Direct Access Number — F407</p> <p>Parameter Type — Numerical</p> <p>Factory Default — 1730</p> <p>Changeable During Run — Yes</p> <p>Minimum — 100</p> <p>Maximum — 60000</p> <p>Units — RPM</p>
<p>Base Frequency Voltage 1</p> <p>Program ⇒ Vector ⇒ Vector Motor Model</p> <p>The Motor 1 Base Frequency Voltage 1 is the Motor 1 output voltage at the Base Frequency (F014). Regardless of the programmed value, the output voltage cannot be higher than the input voltage.</p> <p>The actual output voltage will be influenced by the input voltage of the ASD and the Supply Voltage Correction setting (F307).</p>	<p>Direct Access Number — F409</p> <p>Parameter Type — Numerical</p> <p>Factory Default — (ASD-Dependent)</p> <p>Changeable During Run — Yes</p> <p>Minimum — 50.0</p> <p>Maximum — 660.0</p> <p>Units — Volts</p>

<p>Motor Constant 1 (Torque Boost)</p> <p>Program ⇒ Motor ⇒ Vector Motor Model</p> <p>This parameter sets the primary resistance of the motor. Increasing this value can prevent a drop in the torque of the motor at low speeds. Increasing this value excessively can result in nuisance overload tripping.</p>	<p>Direct Access Number — F410</p> <p>Parameter Type — Numerical</p> <p>Factory Default — (ASD-Dependent)</p> <p>Changeable During Run — Yes</p> <p>Minimum — 0.0</p> <p>Maximum — 30.0</p> <p>Units — %</p>
<p>Motor Constant 2 (No-Load Current)</p> <p>Program ⇒ Motor ⇒ Vector Motor Model</p> <p>This parameter is used to set the current level required to excite the motor. Specifying a value that is too high for this parameter may result in hunting (erratic motor operation).</p>	<p>Direct Access Number — F411</p> <p>Parameter Type — Numerical</p> <p>Factory Default — (ASD-Dependent)</p> <p>Changeable During Run — No</p> <p>Minimum — 10</p> <p>Maximum — 90</p> <p>Units — %</p>
<p>Motor Constant 3 (Leak Inductance)</p> <p>Program ⇒ Motor ⇒ Vector Motor Model</p> <p>This parameter is used to set the leakage inductance of the motor. A larger setting here results in higher output torque at high speeds.</p>	<p>Direct Access Number — F412</p> <p>Parameter Type — Numerical</p> <p>Factory Default — (ASD-Dependent)</p> <p>Changeable During Run — Yes</p> <p>Minimum — 0</p> <p>Maximum — 200</p> <p>Units — %</p>
<p>Motor Constant 4 (Rated Slip)</p> <p>Program ⇒ Motor ⇒ Vector Motor Model</p> <p>This parameter is used to set the secondary resistance of the motor. An increase in this parameter setting results in an increase of compensation for motor slip.</p>	<p>Direct Access Number — F413</p> <p>Parameter Type — Numerical</p> <p>Factory Default — (ASD-Dependent)</p> <p>Changeable During Run — Yes</p> <p>Minimum — 0.01</p> <p>Minimum — 25.00</p> <p>Units — %</p>
<p>Exciting Strengthening Coefficient</p> <p>Program ⇒ Special ⇒ Special Parameters</p> <p>This parameter is used to increase the magnetic flux of the motor at low-speed. This feature is useful when increased torque at low speeds is required.</p>	<p>Direct Access Number — F415</p> <p>Parameter Type — Numerical</p> <p>Factory Default — 100</p> <p>Changeable During Run — Yes</p> <p>Minimum — 100</p> <p>Maximum — 130</p> <p>Units — %</p>

Stall Prevention Factor 1

Program ⇒ Protection ⇒ Stall

This parameter is to be adjusted in the event that the motor stalls when operated above the base frequency.

If a momentary heavy load occurs the motor may stall before the load current reaches the stall prevention level setting of **F601**.

A drop in the supply voltage may cause fluctuations of the load current or may cause motor vibration. A gradual adjustment of this parameter may alleviate this condition.

Start with a setting of 85 at these parameters and gradually adjust them from there one at a time until the desired results are produced.

Adjustments to this parameter may increase the load current of the motor and subsequently warrant an adjustment at the **Motor Overload Protection Level** setting.

Direct Access Number — F416Parameter Type — **Numerical**Factory Default — **100**Changeable During Run — **No**

Minimum — 10

Maximum — 250

Torque Command Selection

Program ⇒ Torque ⇒ Torque Control

When operating in the **Torque Control** mode, this parameter allows the user to select the source of the torque command signal.

Settings:

- 1 — V/I
- 2 — RR
- 3 — RX
- 4 — EOI (Keypad) (**F725** Setting)
- 5 — RS485 2-Wire
- 6 — RS485 4-Wire
- 7 — Communication Option Board
- 8 — RX2 Option (A11)

Direct Access Number — F420Parameter Type — **Selection List**Factory Default — **RX**Changeable During Run — **Yes**

Tension Torque Bias Input

Program ⇒ Torque ⇒ Torque Control

This parameter **Enables/Disables** the **Tension Torque Bias** input function.

This feature is enabled by selecting a **Tension Torque Bias** input signal source.

Settings:

- 0 — Disabled
- 1 — V/I
- 2 — RR
- 3 — RX
- 4 — EOI (Keypad)
- 5 — RS485 2-Wire
- 6 — RS485 4-Wire
- 7 — Communication Option Board
- 8 — RX2 Option (A11)

Direct Access Number — F423Parameter Type — **Selection List**Factory Default — **Disabled**Changeable During Run — **Yes**

Load Sharing Gain Input

Program ⇒ Torque ⇒ Torque Control

This parameter **Enables/Disables** the **Load Sharing Gain** input function.This feature is enabled by selecting a **Load Sharing Gain** input signal source.

Settings:

- 0 — Disabled
- 1 — V/I
- 2 — RR
- 3 — RX
- 4 — EOI (Keypad)
- 5 — RS485 2-Wire
- 6 — RS485 4-Wire
- 7 — Communication Option Board
- 8 — RX2 Option (A11)

Direct Access Number — F424Parameter Type — **Selection List**Factory Default — **Disabled**Changeable During Run — **Yes**

Forward Speed Limit Input

Program ⇒ Torque ⇒ Torque Speed Limiting

This parameter **Enables/Disables** the **Forward Speed Limit Input** control function. When enabled and operating in the **Torque Control** mode, the forward speed limit is controlled by the input selected here.If **Setting** is selected, the value set at [F426](#) is used as the **Forward Speed Limit** input.

Settings:

- 0 — Disabled
- 1 — V/I
- 2 — RR
- 3 — RX
- 4 — [F426](#) (Setting)

Direct Access Number — F425Parameter Type — **Selection List**Factory Default — **Disabled**Changeable During Run — **Yes**

Forward Speed Limit Level

Program ⇒ Torque ⇒ Torque Control

This parameter provides a value to be used as the **Forward Speed Limit** setting if [F426](#) is selected at [F425](#).**Direct Access Number** — F426Parameter Type — **Numerical**Factory Default — **80.0**Changeable During Run — **Yes**

Minimum — 0.00

Maximum — **Upper-Limit (F012)**

Units — Hz

Reverse Speed Limit Input

Program ⇒ Torque ⇒ Torque Control

This parameter **Enables/Disables** the **Reverse Speed Limit Input** control function. When enabled and operating in the **Torque Control** mode, the reverse speed limit is controlled by the terminal selected here. If **Setting** is selected, the value set at [F428](#) is used as the **Reverse Speed Limit** input.

Settings:

- 0 — Disabled
- 1 — V/I
- 2 — RR
- 3 — RX
- 4 — Setting ([F428](#))

Direct Access Number — F427Parameter Type — **Selection List**Factory Default — **Disabled**Changeable During Run — **Yes****Reverse Speed Limit Input Level**

Program ⇒ Torque ⇒ Torque Control

This parameter provides a value to be used as the **Reverse Speed Limit** setting if **Setting** is selected at [F427](#).

Direct Access Number — F428Parameter Type — **Numerical**Factory Default — **80.0**Changeable During Run — **Yes**

Minimum — 0.00

Maximum — **Upper-Limit ([F012](#))**

Units — Hz

Speed Limit (torque=0) Center Value Reference

Program ⇒ Torque ⇒ Torque Speed Limiting

The system has the ability to limit the amount that the speed may vary as a function of a changing load while operating in the **Torque Control** mode. This parameter sets the input terminal that will be used to control the allowable speed variance.

Settings:

- 0 — Disabled
- 1 — V/I
- 2 — RR
- 3 — RX
- 4 — [F431](#) Setting

Direct Access Number — F430Parameter Type — **Selection List**Factory Default — **Disabled**Changeable During Run — **Yes****Speed Limit (torque=0) Center Value**

Program ⇒ Torque ⇒ Torque Speed Limiting

The system has the ability to limit the amount that the speed may vary as a function of a changing load while operating in the **Torque Control** mode. This parameter sets the targeted speed. The plus-or-minus value (range) for this setting may be set at [F432](#).

Direct Access Number — F431Parameter Type — **Numerical**Factory Default — **0.00**Changeable During Run — **Yes**

Minimum — 0.00

Maximum — **Max. Freq. ([F011](#))**

Units — Hz

<p>Speed Limit (torque=0) Band</p> <p>Program ⇒ Torque ⇒ Torque Speed Limiting</p> <p>The system has the ability to limit the amount that the speed may vary as a function of a changing load while operating in the Torque Control mode. This parameter sets a plus-or-minus value (range) for the Speed Limit Torque Level (F431).</p>	<p>Direct Access Number — F432</p> <p>Parameter Type — Numerical</p> <p>Factory Default — 0.00</p> <p>Changeable During Run — Yes</p> <p>Minimum — 0.00</p> <p>Maximum — Max. Freq. (F011)</p> <p>Units — Hz</p>
<p>Rotation in Specified Direction ONLY</p> <p>Program ⇒ Torque ⇒ Torque Speed Limiting</p> <p>This parameter Enables/Disables the Forward Run or Reverse Run mode.</p> <p>If either direction is disabled, commands received for the disabled direction will not be recognized.</p> <p>If both directions are disabled, the received direction command will determine the direction of the motor rotation.</p> <p>Settings</p> <ul style="list-style-type: none"> 0 — Disabled 1 — Enabled 	<p>Direct Access Number — F435</p> <p>Parameter Type — Selection List</p> <p>Factory Default — Disabled</p> <p>Changeable During Run — No</p>
<p>Power Running Torque Limit 1</p> <p>Program ⇒ Torque ⇒ Torque Limit Settings</p> <p>This parameter determines the source of the control signal for the positive torque limit setting.</p> <p>If Setting is selected, the value set at F441 is used as the Power Running Torque Limit 1 input.</p> <p>Settings:</p> <ul style="list-style-type: none"> 1 — V/I 2 — RR 3 — RX 4 — F441 (Setting) 	<p>Direct Access Number — F440</p> <p>Parameter Type — Selection List</p> <p>Factory Default — F441 Setting</p> <p>Changeable During Run — Yes</p>
<p>Power Running Torque Limit 1 Level</p> <p>Program ⇒ Torque ⇒ Torque Limit Settings</p> <p>This parameter provides a value for the Power Running Torque Limit 1 setting if F441 is selected at parameter F440.</p> <p>This value provides the positive torque upper-limit for the 1 motor.</p>	<p>Direct Access Number — F441</p> <p>Parameter Type — Numerical</p> <p>Factory Default — 250.0 (Disabled)</p> <p>Changeable During Run — Yes</p> <p>Minimum — 0.00</p> <p>Maximum — 250.0 (Disabled)</p> <p>Units — %</p>

<p>Regenerative Braking Torque Limit 1</p> <p>Program ⇒ Torque ⇒ Torque Limit Settings</p> <p>This parameter determines the source of the Regenerative Torque Limit control signal.</p> <p>If Setting is selected, the value set at F443 is used for this parameter.</p> <p>Settings:</p> <ul style="list-style-type: none"> 1 — V/I 2 — RR 3 — RX 4 — F443 (Setting) 	<p>Direct Access Number — F442</p> <p>Parameter Type — Selection List</p> <p>Factory Default — F443 Setting</p> <p>Changeable During Run — Yes</p>
<p>Regenerative Braking Torque Limit 1 Level</p> <p>Program ⇒ Torque ⇒ Torque Limit Settings</p> <p>This parameter provides a value to be used as the Regeneration Torque Limit 1 if F443 is selected at parameter F442.</p> <p>Set this parameter to 250% to disable this function.</p>	<p>Direct Access Number — F443</p> <p>Parameter Type — Numerical</p> <p>Factory Default — 250.0 (Disabled)</p> <p>Changeable During Run — Yes</p> <p>Minimum — 0.00</p> <p>Maximum — 249.9</p> <p>Units — %</p>
<p>Power Running Torque Limit 2 Level</p> <p>Program ⇒ Torque ⇒ Manual Torque Limit Settings</p> <p>This parameter is used to set the positive torque upper-limit for the 2 motor profile when multiple motors are controlled by a single drive or when a single motor is to be controlled by multiple profiles.</p>	<p>Direct Access Number — F444</p> <p>Parameter Type — Numerical</p> <p>Factory Default — 250.0 (Disabled)</p> <p>Changeable During Run — Yes</p> <p>Minimum — 0.00</p> <p>Maximum — 250.0 (Disabled)</p> <p>Units — %</p>
<p>Regenerative Braking Torque Limit 2 Level</p> <p>Program ⇒ Torque ⇒ Manual Torque Limit Settings</p> <p>This parameter is used to set the negative torque upper-limit for the 2 motor profile when multiple motors are controlled by a single drive or when a single motor is to be controlled by multiple profiles.</p>	<p>Direct Access Number — F445</p> <p>Parameter Type — Numerical</p> <p>Factory Default — 250.0 (Disabled)</p> <p>Changeable During Run — Yes</p> <p>Minimum — 0.00</p> <p>Maximum — 250.0 (Disabled)</p> <p>Units — %</p>
<p>Power Running Torque Limit 3 Level</p> <p>Program ⇒ Torque ⇒ Manual Torque Limit Settings</p> <p>This parameter is used to set the positive torque upper-limit for the 3 motor profile when multiple motors are controlled by a single drive or when a single motor is to be controlled by multiple profiles.</p>	<p>Direct Access Number — F446</p> <p>Parameter Type — Numerical</p> <p>Factory Default — 250.0 (Disabled)</p> <p>Changeable During Run — Yes</p> <p>Minimum — 0.00</p> <p>Maximum — 250.0 (Disabled)</p> <p>Units — %</p>

<p>Regenerative Braking Torque Limit 3 Level</p> <p>Program ⇒ Torque ⇒ Manual Torque Limit Settings</p> <p>This parameter is used to set the negative torque upper-limit for the 3 motor profile when multiple motors are controlled by a single drive or when a single motor is to be controlled by multiple profiles.</p>	<p>Direct Access Number — F447</p> <p>Parameter Type — Numerical</p> <p>Factory Default — 250.0 (Disabled)</p> <p>Changeable During Run — Yes</p> <p>Minimum — 0.00</p> <p>Maximum — 250.0 (Disabled)</p> <p>Units — %</p>
<p>Power Running Torque Limit 4 Level</p> <p>Program ⇒ Torque ⇒ Manual Torque Limit Settings</p> <p>This parameter is used to set the positive torque upper-limit for the 4 motor profile when multiple motors are controlled by a single drive or when a single motor is to be controlled by multiple profiles.</p>	<p>Direct Access Number — F448</p> <p>Parameter Type — Numerical</p> <p>Factory Default — 250.0 (Disabled)</p> <p>Changeable During Run — Yes</p> <p>Minimum — 0.00</p> <p>Maximum — 250.0 (Disabled)</p> <p>Units — %</p>
<p>Regenerative Braking Torque Limit 4 Level</p> <p>Program ⇒ Torque ⇒ Manual Torque Limit Settings</p> <p>This parameter is used to set the negative torque upper-limit for the 4 motor profile when multiple motors are controlled by a single drive or when a single motor is to be controlled by multiple profiles.</p>	<p>Direct Access Number — F449</p> <p>Parameter Type — Numerical</p> <p>Factory Default — 250.0 (Disabled)</p> <p>Changeable During Run — Yes</p> <p>Minimum — 0.00</p> <p>Maximum — 250.0 (Disabled)</p> <p>Units — %</p>
<p>Accel/Decel Operation After Torque Limit</p> <p>Program ⇒ Torque ⇒ Torque Limit Settings</p> <p>In a Crane/Hoist application that is operating using a mechanical brake, this parameter is used to minimize the delay between the brake release and the output torque reaching a level that can sustain the load.</p> <p>This setting may reference time or the operating speed of the motor.</p> <p>Settings:</p> <ul style="list-style-type: none"> 0 — In Sync with Accel/Decel 1 — In Sync with Minimum Time 	<p>Direct Access Number — F451</p> <p>Parameter Type — Selection List</p> <p>Factory Default — In Sync with Accel/Decel</p> <p>Changeable During Run — Yes</p>
<p>Power Running Stall Continuous Trip Detection Time</p> <p>Program ⇒ Protection ⇒ Stall</p> <p>This parameter is used to extend the Over-Voltage Stall (F305) and the Over-Current Stall (F017) time settings.</p>	<p>Direct Access Number — F452</p> <p>Parameter Type — Numerical</p> <p>Factory Default — 0.0</p> <p>Changeable During Run — Yes</p> <p>Minimum — 0.0</p> <p>Maximum — 1.0</p> <p>Units — Seconds</p>

<p>Stall Prevention During Regeneration</p> <p>Program ⇒ Protection ⇒ Stall</p> <p>This function of this parameter is to disable the Over-Voltage Stall (F305) and the Over-Current Stall (F017) function during regeneration <u>only</u>.</p> <p>Application-specific conditions may occur that warrant disabling the Stall function during regeneration.</p> <p>Settings:</p> <ul style="list-style-type: none"> 0 — Disabled (Stall During Regenerative Braking) 1 — Enabled (No Stall During Regenerative Braking) 	<p>Direct Access Number — F453</p> <p>Parameter Type — Selection List</p> <p>Factory Default — Enabled</p> <p>Changeable During Run — Yes</p>
<p>Current Control Proportional Gain</p> <p>Program ⇒ Feedback ⇒ PG Settings</p> <p>This parameter sets the sensitivity of the drive when monitoring the output current to control speed.</p> <p>The larger the value entered here, the more sensitive the drive is to changes in the received feedback.</p>	<p>Direct Access Number — F458</p> <p>Parameter Type — Numerical</p> <p>Factory Default — (ASD-Dependent)</p> <p>Changeable During Run — No</p> <p>Minimum — 0.0</p> <p>Maximum — 100.0</p>
<p>Speed Loop Proportional Gain</p> <p>Program ⇒ Feedback ⇒ PG Settings</p> <p>During closed-loop operation, this parameter sets the response sensitivity of the drive when monitoring the output speed for control.</p> <p>The larger the value entered here, the larger the change in the output speed for a given received feedback signal.</p>	<p>Direct Access Number — F460</p> <p>Parameter Type — Numerical</p> <p>Factory Default — (ASD-Dependent)</p> <p>Changeable During Run — No</p> <p>Minimum — 1</p> <p>Maximum — 9999</p>
<p>Speed Loop Stabilization Coefficient</p> <p>Program ⇒ Feedback ⇒ PG Settings</p> <p>During closed-loop operation, this parameter sets the response sensitivity of the drive when monitoring the output speed for control.</p> <p>The larger the value entered here, the quicker the response to changes in the received feedback.</p>	<p>Direct Access Number — F461</p> <p>Parameter Type — Numerical</p> <p>Factory Default — 100</p> <p>Changeable During Run — Yes</p> <p>Minimum — 1</p> <p>Maximum — 9999</p>
<p>Load Moment of Inertia 1</p> <p>Program ⇒ Feedback ⇒ PG Settings</p> <p>This parameter is used for calculating accel/decel torque when compensating for load inertia while operating in the Drooping Control mode.</p>	<p>Direct Access Number — F462</p> <p>Parameter Type — Numerical</p> <p>Factory Default — 35</p> <p>Changeable During Run — Yes</p> <p>Minimum — 0</p> <p>Maximum — 100</p>
<p>Second Speed Loop Proportional Gain</p> <p>Program ⇒ Feedback ⇒ PG Settings</p> <p>During closed-loop operation, this parameter sets the sensitivity of the drive when monitoring the output speed for control.</p> <p>The larger the value entered here, the more sensitive the drive is to changes in the received feedback.</p>	<p>Direct Access Number — F463</p> <p>Parameter Type — Numerical</p> <p>Factory Default — (ASD-Dependent)</p> <p>Changeable During Run — No</p> <p>Minimum — 1</p> <p>Maximum — 9999</p>

<p>Second Speed Loop Stabilization Coefficient</p> <p>Program ⇒ Feedback ⇒ PG Settings</p> <p>During closed-loop operation, this parameter sets the response sensitivity of the drive when monitoring the output speed for control.</p> <p>The larger the value entered here, the quicker the response to changes in the received feedback.</p>	<p>Direct Access Number — F464</p> <p>Parameter Type — Numerical</p> <p>Factory Default — 1</p> <p>Changeable During Run — Yes</p> <p>Minimum — 1</p> <p>Maximum — 9999</p>
<p>Load Moment of Inertia 2</p> <p>Program ⇒ Feedback ⇒ PG Settings</p> <p>This parameter is used for calculating accel/decel torque when compensating for load inertia while operating in the Drooping Control mode.</p>	<p>Direct Access Number — F465</p> <p>Parameter Type — Numerical</p> <p>Factory Default — 35</p> <p>Changeable During Run — Yes</p> <p>Minimum — 0</p> <p>Maximum — 100</p>
<p>Speed PID Switching Frequency</p> <p>Program ⇒ Feedback ⇒ Feedback Settings</p> <p>While running, this parameter establishes the threshold speed setting that is used to determine if PID control may engage or remain engaged if active.</p>	<p>Direct Access Number — F466</p> <p>Parameter Type — Numerical</p> <p>Factory Default — 0.00</p> <p>Changeable During Run — Yes</p> <p>Minimum — 0.00</p> <p>Maximum — Max. Freq. (F011)</p> <p>Units — Hz</p>
<p>V/I Input Bias</p> <p>Program ⇒ Frequency ⇒ Speed Reference Setpoints</p> <p>This parameter is used to fine-tune the bias of the V/I input terminals.</p> <p><i>Note:</i> See note on pg. 44 for more information on the V/I terminal.</p> <p>This setting may be used to ensure that the zero level of the input source (pot, pressure transducer, flow meter, etc.) is also the zero level setting of the ASD system.</p> <p>This is accomplished by setting the input source to zero and adjusting this setting to provide an output of zero from the ASD.</p>	<p>Direct Access Number — F470</p> <p>Parameter Type — Numerical</p> <p>Factory Default — 127</p> <p>Changeable During Run — Yes</p> <p>Minimum — 0</p> <p>Maximum — 255</p>
<p>V/I Input Gain</p> <p>Program ⇒ Frequency ⇒ Speed Reference Setpoints</p> <p>This parameter is used to fine tune the gain of the V/I input terminals.</p> <p><i>Note:</i> See note on pg. 44 for more information on the V/I terminal.</p> <p>This setting may be used to ensure that the 100% level of the input source (pot, pressure transducer, flow meter, etc.) is also the 100% level setting of the ASD system.</p> <p>This is accomplished by setting the input source to 100% and adjusting this setting to provide an output of 100% from the ASD.</p>	<p>Direct Access Number — F471</p> <p>Parameter Type — Numerical</p> <p>Factory Default — 129</p> <p>Changeable During Run — Yes</p> <p>Minimum — 0</p> <p>Maximum — 255</p>

RR Input Bias

Program ⇒ Frequency ⇒ Speed Reference Setpoints

This parameter is used to fine tune the bias of the **RR** input terminal when this terminal is used as the control input while operating in the **Speed Control** mode or the **Torque Control** mode.

This setting may be used to ensure that the zero level of the input source (pot, pressure transducer, flow meter, etc.) is also the zero level setting of the ASD system.

This is accomplished by setting the input source to zero and adjusting this setting to provide an output of zero from the ASD.

Direct Access Number — F472Parameter Type — **Numerical**Factory Default — **128**Changeable During Run — **Yes**

Minimum — 0

Maximum — 255

RR Input Gain

Program ⇒ Frequency ⇒ Speed Reference Setpoints

This parameter is used to fine tune the gain of the **RR** input terminal when this terminal is used as the control input while operating in the **Speed Control** mode or the **Torque Control** mode.

This setting may be used to ensure that the 100% level of the input source (pot, pressure transducer, flow meter, etc.) is also the 100% level setting of the ASD system.

This is accomplished by setting the input source to 100% and adjusting this setting to provide an output of 100% from the ASD.

Direct Access Number — F473Parameter Type — **Numerical**Factory Default — **154**Changeable During Run — **Yes**

Minimum — 0

Maximum — 255

RX Input Bias

Program ⇒ Frequency ⇒ Speed Reference Setpoints

This parameter is used to fine tune the bias of the **RX** input terminal when this terminal is used as the control input while operating in the **Speed Control** mode or the **Torque Control** mode.

This setting may be used to ensure that the zero level of the input source (pot, pressure transducer, flow meter, etc.) is also the zero level setting of the ASD system.

This is accomplished by setting the input source to zero and adjusting this setting to provide an output of zero from the ASD.

Direct Access Number — F474Parameter Type — **Numerical**Factory Default — **127**Changeable During Run — **Yes**

Minimum — 0

Maximum — 255

RX Input Gain

Program ⇒ Frequency ⇒ Speed Reference Setpoints

This parameter is used to fine tune the gain of the **RX** input terminal when this terminal is used as the control input while operating in the **Speed Control** mode or the **Torque Control** mode.

This setting may be used to ensure that the 100% level of the input source (pot, pressure transducer, flow meter, etc.) is also the 100% level setting of the ASD system.

This is accomplished by setting the input source to 100% and adjusting this setting to provide an output of 100% from the ASD.

Direct Access Number — F475Parameter Type — **Numerical**Factory Default — **127**Changeable During Run — **Yes**

Minimum — 0

Maximum — 255

<p>RX2 (AI1) Input Bias</p> <p>Program ⇒ Frequency ⇒ Speed Reference Setpoints</p> <p>This parameter is used to fine tune the bias of the RX2 (AI1) input terminal when this terminal is used as the control input while operating in the Speed Control mode or the Torque Control mode.</p> <p>This setting may be used to ensure that the zero level of the input source (pot, pressure transducer, flow meter, etc.) is also the zero level setting of the ASD system.</p> <p>This is accomplished by setting the input source to zero and adjusting this setting to provide a zero output from the ASD.</p>	<p>Direct Access Number — F476</p> <p>Parameter Type — Numerical</p> <p>Factory Default — 128</p> <p>Changeable During Run — Yes</p> <p>Minimum — 0</p> <p>Maximum — 255</p>
<p>RX2 (AI1) Input Gain</p> <p>Program ⇒ Frequency ⇒ Speed Reference Setpoints</p> <p>This parameter is used to fine tune the gain of the RX2 (AI1) input terminal when this terminal is used as the control input while operating in the Speed Control mode or the Torque Control mode.</p> <p>This setting may be used to ensure that the 100% level of the input source (pot, pressure transducer, flow meter, etc.) is also the 100% level setting of the ASD system.</p> <p>This is accomplished by setting the input source to 100% and adjusting this setting to provide an output of 100% from the ASD.</p>	<p>Direct Access Number — F477</p> <p>Parameter Type — Numerical</p> <p>Factory Default — 128</p> <p>Changeable During Run — Yes</p> <p>Minimum — 0</p> <p>Maximum — 255</p>
<p>AI2 (Option V/I) Input Bias</p> <p>Program ⇒ Frequency ⇒ Speed Reference Setpoints</p> <p>This parameter is used to fine tune the gain of the Optional AI2 input terminal when this terminal is used as the control input while operating in the Speed Control mode or the Torque Control mode.</p> <p>This setting may be used to ensure that the 100% level of the input source (pot, pressure transducer, flow meter, etc.) is also the 100% level setting of the ASD system.</p> <p>This is accomplished by setting the input source to 100% and adjusting this setting to provide an output of 100% from the ASD.</p>	<p>Direct Access Number — F478</p> <p>Parameter Type — Numerical</p> <p>Factory Default — 128</p> <p>Changeable During Run — Yes</p> <p>Minimum — 0</p> <p>Maximum — 255</p>
<p>AI2 (Option V/I) Input Gain</p> <p>Program ⇒ Frequency ⇒ Speed Reference Setpoints</p> <p>This parameter is used to fine tune the gain of the Optional AI2 input terminal when this terminal is used as the control input while operating in the Speed Control mode or the Torque Control mode.</p> <p>This setting may be used to ensure that the 100% level of the input source (pot, pressure transducer, flow meter, etc.) is also the 100% level setting of the ASD system.</p> <p>This is accomplished by setting the input source to 100% and adjusting this setting to provide an output of 100% from the ASD.</p>	<p>Direct Access Number — F479</p> <p>Parameter Type — Numerical</p> <p>Factory Default — 128</p> <p>Changeable During Run — Yes</p> <p>Minimum — 0</p> <p>Maximum — 255</p>

Permanent Magnet (PM) Motor Constant 1

Program ⇒ Motor ⇒ PM Motor

This parameter is used with synchronous motor applications only.
Contact the TIC Customer Support Center for information on this parameter.

Direct Access Number — F498

Parameter Type — **Numerical**
Factory Default — **(ASD-Dependent)**
Changeable During Run — **Yes**
Minimum — 0
Maximum — 100
Units — %

Permanent Magnet (PM) Motor Constant 2

Program ⇒ Motor ⇒ PM Motor

This parameter is used with synchronous motor applications only.
Contact the TIC Customer Support Center for information on this parameter.

Direct Access Number — F499

Parameter Type — **Numerical**
Factory Default — **(ASD-Dependent)**
Changeable During Run — **Yes**
Minimum — 0
Maximum — 100
Units — %

Acceleration Time 2

Program ⇒ Special ⇒ Acc/Decel 1 – 4 Settings

This parameter specifies the time in seconds for the output of the ASD to go from 0.0 Hz to the **Maximum Frequency** for the **2 Acceleration** profile. The Accel/Decel pattern may be set using [F502](#). The minimum Accel/Decel time may be set using [F508](#).

This setting is also used to determine the acceleration rate of the **UP/DOWN Frequency Functions**.

***Note:** An acceleration time shorter than the load will allow may cause nuisance tripping and mechanical stress to loads. **Automatic Accel/Decel, Stall, and Ridethrough** settings may lengthen the acceleration times.*

Direct Access Number — F500

Parameter Type — **Numerical**
Factory Default — **(ASD-Dependent)**
Changeable During Run — **Yes**
Minimum — 0.1
Maximum — 6000.0
Units — Seconds

Deceleration Time 2

Program ⇒ Fundamental ⇒ Accel/Decel 1 Settings

This parameter specifies the time in seconds for the output of the ASD to go from the **Maximum Frequency** to 0.0 Hz for the **2 Deceleration** profile. The Accel/Decel pattern may be set using [F502](#). The minimum Accel/Decel time may be set using [F508](#).

This setting is also used to determine the deceleration rate of the **UP/DOWN Frequency Functions**.

***Note:** A deceleration time shorter than the load will allow may cause nuisance tripping and mechanical stress to loads. **Automatic Accel/Decel, Stall, and Ridethrough** settings may lengthen the deceleration times.*

Direct Access Number — F501

Parameter Type — **Numerical**
Factory Default — **(ASD-Dependent)**
Changeable During Run — **Yes**
Minimum — 0.1
Maximum — 6000
Units — Seconds

Acc/Dec Pattern 1

Program ⇒ Special ⇒ Accel/Decel 1 – 4 Settings

This parameter enables a user-selected preprogrammed output profile that controls the acceleration and deceleration pattern for the **1 Accel/Decel** parameter.

Settings:

- 0 — Linear
- 1 — S-Pattern 1
- 2 — S-Pattern 2

The figures below provide a profile of the available accel/decel patterns.

Linear acceleration and deceleration is the default pattern and is used on most applications.

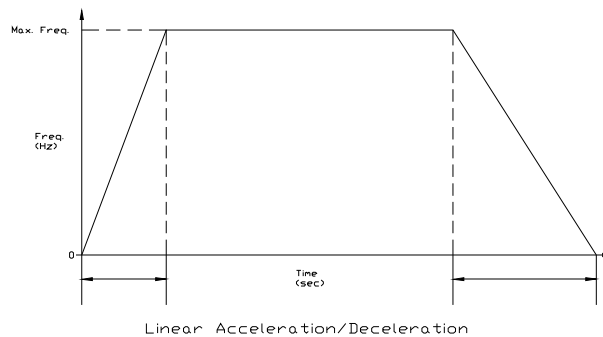

S-pattern 1 is used for applications that require quick acceleration and deceleration. This setting is also popular for applications that require shock absorption at the start of acceleration or deceleration.

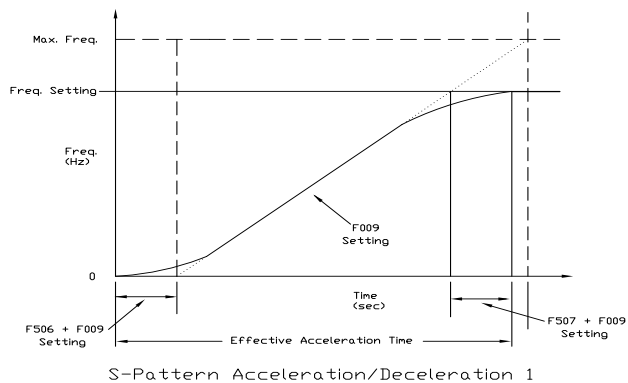

S-pattern 2 decreases the rate of change above the base frequency for acceleration and deceleration.

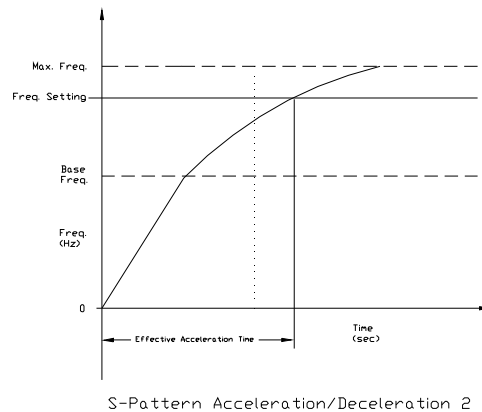

Acc/Dec Pattern 2

Program ⇒ Special ⇒ Accel/Decel 1 – 4 Settings

This parameter enables a user-selected preprogrammed output profile that controls the acceleration and deceleration pattern for the **2 Accel/Decel** parameter.

Settings:

- 0 — Linear
- 1 — S-Pattern 1
- 2 — S-Pattern 2

Direct Access Number — F503

Parameter Type — **Selection List**

Factory Default — **Linear**

Changeable During Run — **Yes**

Acc/Dec Pattern 1 – 4

Program ⇒ Special ⇒ Acc/Dec Special

Four Acceleration times and four Deceleration times may be set up and run individually. **Accel/Decel Time 1 – 4** may be selected using this parameter setting or switched via threshold frequencies, or by discrete input terminal.

This parameter is used to select one of the four configured accel/decel profiles to be used.

Settings:

- 1 — Acc/Dec 1
- 2 — Acc/Dec 2
- 3 — Acc/Dec 3
- 4 — Acc/Dec 4

Each Accel/Decel selection is comprised of an **Acceleration Time**, **Deceleration Time**, and a **Pattern** selection. Selection 1, 2, and 3 have a **Switching Frequency** setting. The **Switching Frequency** is used as a threshold frequency that, once reached, the ASD switches to the next higher **Acc/Dec** selection (i.e., 1 to 2, 2 to 3, or 3 to 4). **Switching Frequency** settings are also used during deceleration. A switching frequency setting is not required for **Acc/Dec 4**.

Acc/Dec 1 is set up using parameters **F009** (Acc Time), **F010** (Dec Time), **F502** (Pattern), and **F505** (Switching Frequency).

Acc/Dec 2 is set up using parameters **F500** (Acc Time), **F501** (Dec Time), **F503** (Pattern), and **F513** (Switching Frequency).

Acc/Dec 3 is set up using parameters **F510** (Acc Time), **F511** (Dec Time), **F512** (Pattern), and **F517** (Switching Frequency).

Acc/Dec 4 is set up using parameters **F514** (Acc Time), and **F515** (Dec Time), **F516** (Pattern).

This parameter (**F504**) is used to manually select **Acc/Dec 1 – 4**.

To switch using the **Terminal Board**, assign the functions **Acc/Dec Switching 1** and **Acc/Dec Switching 2** to two discrete input terminals. Activation combinations of the two terminals result in the **Acc/Dec 1 – 4** selections as shown in **Table 4**.

Figure 30 shows the setup requirements and the resulting output frequency response when using **Switching Frequency** settings to control the **Acc/Dec** response of the ASD output.

While operating using **S-Pattern 1** the system performance may be further enhanced by the adjustment of parameters **F506 – F509**. These settings provide for upper and lower **Acc/Dec** limit adjustments. These settings are used to extend or shorten the upper or lower **Acc/Dec** curve.

Note: If operating from the Local mode, press Esc from the Frequency Command screen to access this parameter.

Accel/Decel Switching Frequency 1

Program ⇒ Special ⇒ Accel/Decel Special

This parameter sets the frequency at which the acceleration control is switched from the **Accel 1** profile to the **Accel 2** profile during a multiple-acceleration profile configuration.

Direct Access Number — F504

Parameter Type — Selection List

Factory Default — 1

Changeable During Run — Yes

Table 4. Using combinations of discrete terminal activations Accel/Decel profiles 1 – 4 may be selected.

Acc/Dec Switching Truth		
A/D SW 1	A/D SW 2	Acc/Dec # Out
0	0	1
0	1	2
1	0	3
1	1	4
1 = Discrete terminal activation.		

Figure 30. Using Acc/Dec Switching.

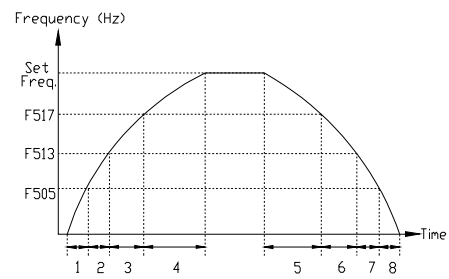

- 1 — Accel time 1 (**F009** setting)
- 2 — Accel time 2 (**F500** setting)
- 3 — Accel time 3 (**F510** setting)
- 4 — Accel time 4 (**F514** setting)
- 5 — Decel time 4 (**F515** setting)
- 6 — Decel time 3 (**F511** setting)
- 7 — Decel time 2 (**F501** setting)
- 8 — Decel time 1 (**F010** setting)

Direct Access Number — F505

Parameter Type — Numerical

Factory Default — 0.00

Changeable During Run — Yes

Minimum — 0.00

Maximum — Max. Freq. (F011)

Units — Hz

<p>S-Pattern Acceleration Lower-Limit Adjustment</p> <p>Program ⇒ Special ⇒ Accel/Decel Special</p> <p>During an S-Pattern 1 or 2 sequence, this parameter settings modifies the acceleration rate for the lower part of the acceleration curve by the percentage set here.</p> <p>This function is commonly used with transportation and lifting applications.</p> <p>See parameter F502 on pg. 165 for more information on this setting.</p>	<p>Direct Access Number — F506</p> <p>Parameter Type — Numerical</p> <p>Factory Default — 10</p> <p>Changeable During Run — Yes</p> <p>Minimum — 0</p> <p>Maximum — 50</p> <p>Units — %</p>
<p>S-Pattern Acceleration Upper-Limit Adjustment</p> <p>Program ⇒ Special ⇒ Accel/Decel Special</p> <p>During an S-Pattern 1 or 2 sequence, this parameter settings modifies the acceleration rate for the upper part of the acceleration curve by the percentage set here.</p> <p>This function is commonly used with transportation and lifting applications.</p> <p>See parameter F502 on pg. 165 for more information on this setting.</p>	<p>Direct Access Number — F507</p> <p>Parameter Type — Numerical</p> <p>Factory Default — 10</p> <p>Changeable During Run — Yes</p> <p>Minimum — 0</p> <p>Maximum — 50</p> <p>Units — %</p>
<p>S-Pattern Deceleration Lower-Limit Adjustment</p> <p>Program ⇒ Special ⇒ Accel/Decel Special</p> <p>During an S-Pattern 1 or 2 sequence, this parameter settings modifies the deceleration rate for the lower part of the deceleration curve by the percentage set here.</p> <p>This function is commonly used with transportation and lifting applications.</p> <p>See parameter F502 on pg. 165 for more information on this setting.</p>	<p>Direct Access Number — F508</p> <p>Parameter Type — Numerical</p> <p>Factory Default — 10</p> <p>Changeable During Run — Yes</p> <p>Minimum — 0</p> <p>Maximum — 50</p> <p>Units — %</p>
<p>S-Pattern Deceleration Upper-Limit Adjustment</p> <p>Program ⇒ Special ⇒ Accel/Decel Special</p> <p>During an S-Pattern 1 or 2 sequence, this parameter settings modifies the deceleration rate for the upper part of the deceleration curve by the percentage set here.</p> <p>This function is commonly used with transportation and lifting applications.</p> <p>See parameter F502 on pg. 165 for more information on this setting.</p>	<p>Direct Access Number — F509</p> <p>Parameter Type — Numerical</p> <p>Factory Default — 10</p> <p>Changeable During Run — Yes</p> <p>Minimum — 0</p> <p>Maximum — 50</p> <p>Units — %</p>
<p>Acceleration Time 3</p> <p>Program ⇒ Special ⇒ Accel/Decel 1 – 4 Settings</p> <p>This parameter specifies the time in seconds for the output of the ASD to go from 0.0 Hz to the Maximum Frequency for the 3 Acceleration profile. The Accel/Decel pattern may be set using F502. The minimum Accel/Decel time may be set using F508.</p> <p><i>Note: An acceleration time shorter than the load will allow may cause nuisance tripping and mechanical stress to loads. Automatic Accel/Decel, Stall, and Ridethrough settings may lengthen the acceleration times.</i></p>	<p>Direct Access Number — F510</p> <p>Parameter Type — Numerical</p> <p>Factory Default — (ASD-Dependent)</p> <p>Changeable During Run — Yes</p> <p>Minimum — 0.1</p> <p>Maximum — 6000</p> <p>Units — Seconds</p>

<p>Deceleration Time 3</p> <p>Program ⇒ Special ⇒ Accel/Decel 1 – 4 Settings</p> <p>This parameter specifies the time in seconds for the output of the ASD to go from the Maximum Frequency to 0.0 Hz for the 3 Deceleration profile.</p> <p>The Accel/Decel pattern may be set using F502. The minimum Accel/Decel time may be set using F508.</p> <p><i>Note: A deceleration time shorter than the load will allow may cause nuisance tripping and mechanical stress to loads. Automatic Accel/Decel, Stall, and Ridethrough settings may lengthen the deceleration times.</i></p>	<p>Direct Access Number — F511</p> <p>Parameter Type — Numerical</p> <p>Factory Default — (ASD-Dependent)</p> <p>Changeable During Run — Yes</p> <p>Minimum — 0.1</p> <p>Maximum — 6000</p> <p>Units — Seconds</p>
<p>Acceleration/Deceleration Pattern 3</p> <p>Program ⇒ Special ⇒ Accel/Decel 1 – 4 Settings</p> <p>This parameter enables a user-selected preprogrammed output profile that controls the acceleration and deceleration pattern for the 3 Accel/Decel parameter.</p> <p>Settings:</p> <ul style="list-style-type: none"> 0 — Linear 1 — S-Pattern 1 2 — S-Pattern 2 	<p>Direct Access Number — F512</p> <p>Parameter Type — Selection List</p> <p>Factory Default — Linear</p> <p>Changeable During Run — Yes</p>
<p>Acceleration/Deceleration Switching Frequency 2</p> <p>Program ⇒ Special ⇒ Accel/Decel Special</p> <p>This parameter sets the frequency at which the acceleration control is switched from the Accel 2 profile to the Accel 3 profile during a multiple-acceleration profile configuration.</p>	<p>Direct Access Number — F513</p> <p>Parameter Type — Numerical</p> <p>Factory Default — 0.00</p> <p>Changeable During Run — Yes</p> <p>Minimum — 0.00</p> <p>Maximum — Max. Freq. (F011)</p> <p>Units — Hz</p>
<p>Acceleration Time 4</p> <p>Program ⇒ Special ⇒ Accel/Decel 1 – 4 Settings</p> <p>This parameter specifies the time in seconds for the output of the ASD to go from 0.0 Hz to the Maximum Frequency for the 4 Acceleration profile. The Accel/Decel pattern may be set using F502. The minimum Accel/Decel time may be set using F508.</p> <p><i>Note: An acceleration time shorter than the load will allow may cause nuisance tripping and mechanical stress to loads. Automatic Accel/Decel, Stall, and Ridethrough settings may lengthen the acceleration times.</i></p>	<p>Direct Access Number — F514</p> <p>Parameter Type — Numerical</p> <p>Factory Default — (ASD-Dependent)</p> <p>Changeable During Run — Yes</p> <p>Minimum — 0.1</p> <p>Maximum — 6000</p> <p>Units — Seconds</p>

Deceleration Time 4

Program ⇒ Special ⇒ Accel/Decel 1 – 4 Settings

This parameter specifies the time in seconds for the output of the ASD to go from the **Maximum Frequency** to 0.0 Hz for the **4 Deceleration** profile. The Accel/Decel pattern may be set using [F502](#). The minimum Accel/Decel time may be set using [F508](#).

***Note:** A deceleration time shorter than the load will allow may cause nuisance tripping and mechanical stress to loads. **Automatic Accel/Decel, Stall, and Ridethrough** settings may lengthen the deceleration times.*

Direct Access Number — F515

Parameter Type — **Numerical**

Factory Default — **(ASD-Dependent)**

Changeable During Run — **Yes**

Minimum — 0.1

Maximum — 6000

Units — Seconds

Acceleration/Deceleration Pattern 4

Program ⇒ Special ⇒ Accel/Decel 1 – 4 Settings

This parameter enables a user-selected preprogrammed output profile that controls the acceleration and deceleration pattern for the **4 Accel/Decel** parameter.

Settings:

0 — Linear

1 — S-Pattern 1

2 — S-Pattern 2

Direct Access Number — F516

Parameter Type — **Selection List**

Factory Default — **Linear**

Changeable During Run — **Yes**

Acceleration/Deceleration Switching Frequency 3

Program ⇒ Special ⇒ Accel/Decel Special

This parameter sets the frequency at which the acceleration control is switched from the **Accel 3** profile to the **Accel 4** profile during a multiple-acceleration profile configuration.

Direct Access Number — F517

Parameter Type — **Numerical**

Factory Default — **0.00**

Changeable During Run — **Yes**

Minimum — 0.00

Maximum — **Max. Freq. (F011)**

Units — Hz

Pattern Operation Selection

Program ⇒ Pattern Run ⇒ Pattern Run

Pattern Run operation is enabled by selecting **Seconds** or **Minutes** as a unit of measure for the **Operation Time** setting for the selected **Preset Speeds**.

See Parameter [F523](#) for more information on **Selections** and **Group Speeds** setup.

Settings:

0 — Disabled

1 — Enabled (Units in Seconds)

2 — Enabled (Units in Minutes)

Direct Access Number — F520

Parameter Type — **Selection List**

Factory Default — **Disabled**

Changeable During Run — **No**

Pattern Operation Mode

Program ⇒ Pattern Run ⇒ Pattern Run

This parameter sets the start condition of subsequent **Pattern Runs** after the initial **Pattern Run** has been terminated or has completed its programming.

Settings:

0 — Reset After Stop

1 — Continue After Stop

Direct Access Number — F521

Parameter Type — **Selection List**

Factory Default — **Reset After Stop**

Changeable During Run — **No**

Pattern 1 Repeat

Program ⇒ Pattern Run ⇒ Pattern Run

This parameter sets the number of times to repeat the **Pattern Group 1**.

Settings:

- 1 = Once Then Stop
- 2 – 254 = Number of Repeats
- 255 = Infinite (Forever)

Direct Access Number — F522

Parameter Type — **Numerical**

Factory Default — **255 (Infinite)**

Changeable During Run — **No**

Minimum — 1

Maximum — 255 (Infinite)

Units — Repetitions

Pattern Group 1 Selection 1

Program ⇒ Pattern Run ⇒ Speeds

Groups of configured **Preset Speeds** may be selected and run from this screen. The execution of grouped **Preset Speeds** in this manner is called a **Pattern Run**.

One to eight user-selected **Preset Speeds** may be run sequentially for a user-set number of repetitions. The group of user-selected **Preset Speeds** is called a **Pattern Group**. The **Pattern Run** function executes the user-set **Pattern Group**.

Pattern Group 1 is comprised of up to 8 **Selections** with each **Selection** being 1 of 15 possible **Preset Speed** settings. **Skip** may be selected to ignore a **Selection**.

This parameter allows the user to choose one configured **Preset Speed** that is to be used as **Selection 1** (of 8) for **Pattern Group 1**. See F018 for information on configuring the individual **Preset Speeds**. Parameters F524 – F530 may be setup for subsequent **Selections 2 – 8**.

One **Preset Speed** number (1 – 15) or **Skip** is selected for **Selection 1** (F523). The number of times to repeat **Pattern Group 1** is selected at F522. Set this value to 255 to run forever.

Setup **Pattern Group 2** at F531 – F539 if more **Preset Speed** entries are required.

Pattern Run Setup (for Pattern Group 1)

- From Program ⇒ Pattern Run ⇒ **Speeds**, select the **Preset Speeds** that are to be used as the **Pattern Group 1** set of **Selections**. Select a speed from the 1 – 15 configured presets; 1 speed number per **Selection**. Set any unused **Selections** to **Skip**.
- From Program ⇒ Pattern Run ⇒ Pattern Run ⇒ **Pattern Operation Selection**, enable the **Pattern Run** mode of operation by selecting **Seconds** or **Minutes** as the unit of measure for the **Operation Time** setting.
- From Program ⇒ Pattern Run ⇒ **Operation Time**, set the run-time for each **Preset Speed** selected in step 1.
- Configure two unused discrete input terminals for **Pattern Operation Group 1** and **Pattern Operation Trigger Signal**.

*Note: Activation of the **Pattern Operation Group 1** discrete input terminal is required to enable **Pattern Group 1** for use. Activation of the **Pattern Operation Trigger Signal** discrete input terminal starts the **Pattern Group 1** pattern run.*

- From Program ⇒ Pattern Run ⇒ Pattern Run ⇒ **Pattern 1 Repeat**, set to the number of times that **Pattern Group 1** is to be run. Set to 255 to run forever.
- From Program ⇒ Pattern Run ⇒ Pattern Run ⇒ **Pattern Operation Mode**, set the end-of-pattern command to **Reset** or **Continue**.
- From the **Remote** mode (**Local/Remote** light is off), initiate a **Run** command (i.e., **F** and/or **R** terminal **On**).
- Connect the **Pattern Operation Group 1** input terminal to **CC**.
- Connect the **Pattern Operation Trigger Signal** input terminal to **CC** and the **Pattern Run** will start and continue as programmed.
- Open the **Pattern Operation Trigger Signal** connection to **CC** to stop the **Pattern Run** before its conclusion if required.

Direct Access Number — F523

Parameter Type — **Selection List**

Factory Default — **Skip**

Changeable During Run — **No**

Minimum — **Skip**

Maximum — 15

Units — **Preset Speed Number**

Pattern Group 1								
	Selection							
	F523	F524	F525	F526	F527	F528	F529	F530
	1	2	3	4	5	6	7	8
Preset Speed Number	Skip	Skip	Skip	Skip	Skip	Skip	Skip	Skip
	1	1	1	1	1	1	1	1
	2	2	2	2	2	2	2	2
	3	3	3	3	3	3	3	3
	4	4	4	4	4	4	4	4
	5	5	5	5	5	5	5	5
	6	6	6	6	6	6	6	6
	7	7	7	7	7	7	7	7
	8	8	8	8	8	8	8	8
	9	9	9	9	9	9	9	9
	10	10	10	10	10	10	10	10
	11	11	11	11	11	11	11	11
	12	12	12	12	12	12	12	12
	13	13	13	13	13	13	13	13
	14	14	14	14	14	14	14	14
15	15	15	15	15	15	15	15	

Pattern Group 1 Selection 2

Program ⇒ Pattern Run ⇒ Speeds

This parameter allows the user to select 1 of 15 configured **Preset Speeds** as the number **2 Selection** to be included in **Pattern Group 1**.

Skip may be selected to ignore this **Selection**.

Setting

0 — Skip

1 – 15 Preset Speed Number

See [F523](#) for more information on this parameter.

Direct Access Number — F524

Parameter Type — Selection List

Factory Default — Skip

Changeable During Run — No

Pattern Group 1 Selection 3

Program ⇒ Pattern Run ⇒ Speeds

This parameter allows the user to select 1 of 15 configured **Preset Speeds** as the number **3 Selection** to be included in **Pattern Group 1**.

Skip may be selected to ignore this **Selection**.

Setting

0 — Skip

1 – 15 Preset Speed Number

See [F523](#) for more information on this parameter.

Direct Access Number — F525

Parameter Type — Selection List

Factory Default — Skip

Changeable During Run — No

Pattern Group 1 Selection 4

Program ⇒ Pattern Run ⇒ Speeds

This parameter allows the user to select 1 of 15 configured **Preset Speeds** as the number **4 Selection** to be included in **Pattern Group 1**.

Skip may be selected to ignore this **Selection**.

Setting

0 — Skip

1 – 15 Preset Speed Number

See [F523](#) for more information on this parameter.

Direct Access Number — F526

Parameter Type — Selection List

Factory Default — Skip

Changeable During Run — No

Pattern Group 1 Selection 5

Program ⇒ Pattern Run ⇒ Speeds

This parameter allows the user to select 1 of 15 configured **Preset Speeds** as the number **5 Selection** to be included in **Pattern Group 1**.

Skip may be selected to ignore this **Selection**.

Setting

0 — Skip

1 – 15 Preset Speed Number

See [F523](#) for more information on this parameter.

Direct Access Number — F527

Parameter Type — Selection List

Factory Default — Skip

Changeable During Run — No

Pattern Group 1 Selection 6

Program ⇒ Pattern Run ⇒ Speeds

This parameter allows the user to select 1 of 15 configured **Preset Speeds** as the number **6 Selection** to be included in **Pattern Group 1**.

Skip may be selected to ignore this **Selection**.

Setting

0 — Skip

1 – 15 Preset Speed Number

See [F523](#) for more information on this parameter.

Direct Access Number — F528

Parameter Type — **Selection List**

Factory Default — **Skip**

Changeable During Run — **No**

Pattern Group 1 Selection 7

Program ⇒ Pattern Run ⇒ Speeds

This parameter allows the user to select 1 of 15 configured **Preset Speeds** as the number **7 Selection** to be included in **Pattern Group 1**.

Skip may be selected to ignore this **Selection**.

Setting

0 — Skip

1 – 15 Preset Speed Number

See [F523](#) for more information on this parameter.

Direct Access Number — F529

Parameter Type — **Selection List**

Factory Default — **Skip**

Changeable During Run — **No**

Pattern Group 1 Selection 8

Program ⇒ Pattern Run ⇒ Speeds

This parameter allows the user to select 1 of 15 configured **Preset Speeds** as the number **8 Selection** to be included in **Pattern Group 1**.

Skip may be selected to ignore this **Selection**.

Setting

0 — Skip

1 – 15 Preset Speed Number

See [F523](#) for more information on this parameter.

Direct Access Number — F530

Parameter Type — **Numerical**

Factory Default — **Skip**

Changeable During Run — **No**

Pattern 2 Repeat

Program ⇒ Pattern Run ⇒ Pattern Run

This parameter sets the number of times to repeat the **Pattern Group 2**.

Direct Access Number — F531

Parameter Type — **Numerical**

Factory Default — **255 (Infinite)**

Changeable During Run — **No**

Minimum — 1

Maximum — 255 (Infinite)

Units — Repetitions

Pattern Group 2 Selection 1

Program ⇒ Pattern Run ⇒ Speeds

This parameter allows the user to select 1 of 15 configured **Preset Speeds** as the number **1** selection to be included in the **Group 2 Selection**.

Skip may be selected to ignore this **Selection**.

Setting

0 — Skip

1 — 15 Preset Speed Number

See [F523](#) for more information on this parameter.

Pattern Group 2 Selection 2

Program ⇒ Pattern Run ⇒ Speeds

This parameter allows the user to select 1 of 15 configured **Preset Speeds** as the number **2** selection to be included in the **Group 2 Selection**.

Skip may be selected to ignore this **Selection**.

Setting

0 — Skip

1 — 15 Preset Speed Number

See [F523](#) for more information on this parameter.

Pattern Group 2 Selection 3

Program ⇒ Pattern Run ⇒ Speeds

This parameter allows the user to select 1 of 15 configured **Preset Speeds** as the number **3** selection to be included in the **Group 2 Selection**.

Skip may be selected to ignore this **Selection**.

Setting

0 — Skip

1 — 15 Preset Speed Number

See [F523](#) for more information on this parameter.

Pattern Group 2 Selection 4

Program ⇒ Pattern Run ⇒ Speeds

This parameter allows the user to select 1 of 15 configured **Preset Speeds** as the number **4** selection to be included in the **Group 2 Selection**.

Skip may be selected to ignore this **Selection**.

Setting

0 — Skip

1 — 15 Preset Speed Number

See [F523](#) for more information on this parameter.

Direct Access Number — F532

Parameter Type — **Selection List**

Factory Default — **Skip**

Changeable During Run — **No**

Direct Access Number — F533

Parameter Type — **Selection List**

Factory Default — **Skip**

Changeable During Run — **No**

Direct Access Number — F534

Parameter Type — **Selection List**

Factory Default — **Skip**

Changeable During Run — **No**

Direct Access Number — F535

Parameter Type — **Selection List**

Factory Default — **Skip**

Changeable During Run — **No**

Pattern Group 2 Selection 5

Program ⇒ Pattern Run ⇒ Speeds

This parameter allows the user to select 1 of 15 configured **Preset Speeds** as the number **5** selection to be included in the **Group 2 Selection**.

Skip may be selected to ignore this **Selection**.

Setting

0 — Skip

1 – 15 Preset Speed Number

See [F523](#) for more information on this parameter.

Direct Access Number — F536

Parameter Type — **Selection List**

Factory Default — **Skip**

Changeable During Run — **No**

Pattern Group 2 Selection 6

Program ⇒ Pattern Run ⇒ Speeds

This parameter allows the user to select 1 of 15 configured **Preset Speeds** as the number **6** selection to be included in the **Group 2 Selection**.

Skip may be selected to ignore this **Selection**.

Setting

0 — Skip

1 – 15 Preset Speed Number

See [F523](#) for more information on this parameter.

Direct Access Number — F537

Parameter Type — **Selection List**

Factory Default — **Skip**

Changeable During Run — **No**

Pattern Group 2 Selection 7

Program ⇒ Pattern Run ⇒ Speeds

This parameter allows the user to select 1 of 15 configured **Preset Speeds** as the number **7** selection to be included in the **Group 2 Selection**.

Skip may be selected to ignore this **Selection**.

Setting

0 — Skip

1 – 15 Preset Speed Number

See [F523](#) for more information on this parameter.

Direct Access Number — F538

Parameter Type — **Selection List**

Factory Default — **Skip**

Changeable During Run — **No**

Pattern Group 2 Selection 8

Program ⇒ Pattern Run ⇒ Speeds

This parameter allows the user to select 1 of 15 configured **Preset Speeds** as the number **8** selection to be included in the **Group 2 Selection**.

Skip may be selected to ignore this **Selection**.

Setting

0 — Skip

1 – 15 Preset Speed Number

See [F523](#) for more information on this parameter.

Direct Access Number — F539

Parameter Type — **Selection List**

Factory Default — **Skip**

Changeable During Run — **No**

<p>Speed 1 Operation Time</p> <p>Program ⇒ Pattern Run ⇒ Operation Time</p> <p>This parameter sets the run-time for Preset Speed 1.</p> <p>This time is effective when used with Group Speeds and non-Group Speeds.</p> <p>If the Auto-Restart function is activated, the search time required for the Auto-Restart function will be subtracted from the Operation Time setting; resulting in a shorter run time.</p>	<p>Direct Access Number — F540</p> <p>Parameter Type — Numerical</p> <p>Factory Default — 5.0</p> <p>Changeable During Run — Yes</p> <p>Minimum — 0.1</p> <p>Maximum — 6000.0</p> <p>Units — F520 Setting</p>
<p>Speed 2 Operation Time</p> <p>Program ⇒ Pattern Run ⇒ Operation Time</p> <p>This parameter sets the run-time for Preset Speed 2.</p> <p>This time is effective when used with Group Speeds and non-Group Speeds.</p> <p>If the Auto-Restart function is activated, the search time required for the Auto-Restart function will be subtracted from the Operation Time setting; resulting in a shorter run time.</p>	<p>Direct Access Number — F541</p> <p>Parameter Type — Numerical</p> <p>Factory Default — 5.0</p> <p>Changeable During Run — Yes</p> <p>Minimum — 0.1</p> <p>Maximum — 6000.0</p> <p>Units — F520 Setting</p>
<p>Speed 3 Operation Time</p> <p>Program ⇒ Pattern Run ⇒ Operation Time</p> <p>This parameter sets the run-time for Preset Speed 3.</p> <p>This time is effective when used with Group Speeds and non-Group Speeds.</p> <p>If the Auto-Restart function is activated, the search time required for the Auto-Restart function will be subtracted from the Operation Time setting; resulting in a shorter run time.</p>	<p>Direct Access Number — F542</p> <p>Parameter Type — Numerical</p> <p>Factory Default — 5.0</p> <p>Changeable During Run — Yes</p> <p>Minimum — 0.1</p> <p>Maximum — 6000.0</p> <p>Units — F520 Setting</p>
<p>Speed 4 Operation Time</p> <p>Program ⇒ Pattern Run ⇒ Operation Time</p> <p>This parameter sets the run-time for Preset Speed 4.</p> <p>This time is effective when used with Group Speeds and non-Group Speeds.</p> <p>If the Auto-Restart function is activated, the search time required for the Auto-Restart function will be subtracted from the Operation Time setting; resulting in a shorter run time.</p>	<p>Direct Access Number — F543</p> <p>Parameter Type — Numerical</p> <p>Factory Default — 5.0</p> <p>Changeable During Run — Yes</p> <p>Minimum — 0.1</p> <p>Maximum — 6000.0</p> <p>Units — F520 Setting</p>
<p>Speed 5 Operation Time</p> <p>Program ⇒ Pattern Run ⇒ Operation Time</p> <p>This parameter sets the run-time for Preset Speed 5.</p> <p>This time is effective when used with Group Speeds and non-Group Speeds.</p> <p>If the Auto-Restart function is activated, the search time required for the Auto-Restart function will be subtracted from the Operation Time setting; resulting in a shorter run time.</p>	<p>Direct Access Number — F544</p> <p>Parameter Type — Numerical</p> <p>Factory Default — 5.0</p> <p>Changeable During Run — Yes</p> <p>Minimum — 0.1</p> <p>Maximum — 6000.0</p> <p>Units — F520 Setting</p>
<p>Speed 6 Operation Time</p> <p>Program ⇒ Pattern Run ⇒ Operation Time</p> <p>This parameter sets the run-time for Preset Speed 6.</p> <p>This time is effective when used with Group Speeds and non-Group Speeds.</p> <p>If the Auto-Restart function is activated, the search time required for the Auto-Restart function will be subtracted from the Operation Time setting; resulting in a shorter run time.</p>	<p>Direct Access Number — F545</p> <p>Parameter Type — Numerical</p> <p>Factory Default — 5.0</p> <p>Changeable During Run — Yes</p> <p>Minimum — 0.1</p> <p>Maximum — 6000.0</p> <p>Units — F520 Setting</p>

<p>Speed 7 Operation Time</p> <p>Program ⇒ Pattern Run ⇒ Operation Time</p> <p>This parameter sets the run-time for Preset Speed 7.</p> <p>This time is effective when used with Group Speeds and non-Group Speeds.</p> <p>If the Auto-Restart function is activated, the search time required for the Auto-Restart function will be subtracted from the Operation Time setting; resulting in a shorter run time.</p>	<p>Direct Access Number — F546</p> <p>Parameter Type — Numerical</p> <p>Factory Default — 5.0</p> <p>Changeable During Run — Yes</p> <p>Minimum — 0.1</p> <p>Maximum — 6000.0</p> <p>Units — F520 Setting</p>
<p>Speed 8 Operation Time</p> <p>Program ⇒ Pattern Run ⇒ Operation Time</p> <p>This parameter sets the run-time for Preset Speed 8.</p> <p>This time is effective when used with Group Speeds and non-Group Speeds.</p> <p>If the Auto-Restart function is activated, the search time required for the Auto-Restart function will be subtracted from the Operation Time setting; resulting in a shorter run time.</p>	<p>Direct Access Number — F547</p> <p>Parameter Type — Numerical</p> <p>Factory Default — 5.0</p> <p>Changeable During Run — Yes</p> <p>Minimum — 0.1</p> <p>Maximum — 6000.0</p> <p>Units — F520 Setting</p>
<p>Speed 9 Operation Time</p> <p>Program ⇒ Pattern Run ⇒ Operation Time</p> <p>This parameter sets the run-time for Preset Speed 9</p> <p>This time is effective when used with Group Speeds and non-Group Speeds.</p> <p>If the Auto-Restart function is activated, the search time required for the Auto-Restart function will be subtracted from the Operation Time setting; resulting in a shorter run time.</p>	<p>Direct Access Number — F548</p> <p>Parameter Type — Numerical</p> <p>Factory Default — 5.0</p> <p>Changeable During Run — Yes</p> <p>Minimum — 0.1</p> <p>Maximum — 6000.0</p> <p>Units — F520 Setting</p>
<p>Speed 10 Operation Time</p> <p>Program ⇒ Pattern Run ⇒ Operation Time</p> <p>This parameter sets the run-time for Preset Speed 10</p> <p>This time is effective when used with Group Speeds and non-Group Speeds.</p> <p>If the Auto-Restart function is activated, the search time required for the Auto-Restart function will be subtracted from the Operation Time setting; resulting in a shorter run time.</p>	<p>Direct Access Number — F549</p> <p>Parameter Type — Numerical</p> <p>Factory Default — 5.0</p> <p>Changeable During Run — Yes</p> <p>Minimum — 0.1</p> <p>Maximum — 6000.0</p> <p>Units — F520 Setting</p>
<p>Speed 11 Operation Time</p> <p>Program ⇒ Pattern Run ⇒ Operation Time</p> <p>This parameter sets the run-time for Preset Speed 11</p> <p>This time is effective when used with Group Speeds and non-Group Speeds.</p> <p>If the Auto-Restart function is activated, the search time required for the Auto-Restart function will be subtracted from the Operation Time setting; resulting in a shorter run time.</p>	<p>Direct Access Number — F550</p> <p>Parameter Type — Numerical</p> <p>Factory Default — 5.0</p> <p>Changeable During Run — Yes</p> <p>Minimum — 0.1</p> <p>Maximum — 6000.0</p> <p>Units — F520 Setting</p>
<p>Speed 12 Operation Time</p> <p>Program ⇒ Pattern Run ⇒ Operation Time</p> <p>This parameter sets the run-time for Preset Speed 12</p> <p>This time is effective when used with Group Speeds and non-Group Speeds.</p> <p>If the Auto-Restart function is activated, the search time required for the Auto-Restart function will be subtracted from the Operation Time setting; resulting in a shorter run time.</p>	<p>Direct Access Number — F551</p> <p>Parameter Type — Numerical</p> <p>Factory Default — 5.0</p> <p>Changeable During Run — Yes</p> <p>Minimum — 0.1</p> <p>Maximum — 6000.0</p> <p>Units — F520 Setting</p>

<p>Speed 13 Operation Time</p> <p>Program ⇒ Pattern Run ⇒ Operation Time</p> <p>This parameter sets the run-time for Preset Speed 13.</p> <p>This time is effective when used with Group Speeds and non-Group Speeds.</p> <p>If the Auto-Restart function is activated, the search time required for the Auto-Restart function will be subtracted from the Operation Time setting; resulting in a shorter run time.</p>	<p>Direct Access Number — F552</p> <p>Parameter Type — Numerical</p> <p>Factory Default — 5.0</p> <p>Changeable During Run — Yes</p> <p>Minimum — 0.1</p> <p>Maximum — 6000.0</p> <p>Units — F520 Setting</p>
<p>Speed 14 Operation Time</p> <p>Program ⇒ Pattern Run ⇒ Operation Time</p> <p>This parameter sets the run-time for Preset Speed 14.</p> <p>This time is effective when used with Group Speeds and non-Group Speeds.</p> <p>If the Auto-Restart function is activated, the search time required for the Auto-Restart function will be subtracted from the Operation Time setting; resulting in a shorter run time.</p>	<p>Direct Access Number — F553</p> <p>Parameter Type — Numerical</p> <p>Factory Default — 5.0</p> <p>Changeable During Run — Yes</p> <p>Minimum — 0.1</p> <p>Maximum — 6000.0</p> <p>Units — F520 Setting</p>
<p>Speed 15 Operation Time</p> <p>Program ⇒ Pattern Run ⇒ Operation Time</p> <p>This parameter sets the run-time for Preset Speed 15.</p> <p>This time is effective when used with Group Speeds and non-Group Speeds.</p> <p>If the Auto-Restart function is activated, the search time required for the Auto-Restart function will be subtracted from the Operation Time setting; resulting in a shorter run time.</p>	<p>Direct Access Number — F554</p> <p>Parameter Type — Numerical</p> <p>Factory Default — 5.0</p> <p>Changeable During Run — Yes</p> <p>Minimum — 0.1</p> <p>Maximum — 6000.0</p> <p>Units — F520 Setting</p>
<p>Preset Speed Operation Mode</p> <p>Program ⇒ Pattern Run ⇒ Operation Mode</p> <p>This parameter is used to set the Preset Speed operating mode.</p> <p>Select Disabled at this parameter to use the speed command only for Preset Speed operation.</p> <p>Select Enabled at this parameter to apply the control settings of F561 – F575 to the associated Preset Speed while operating in the Preset Speed mode.</p> <p>Settings:</p> <ul style="list-style-type: none"> 0 — Disabled (Preset Speed Only) 1 — Enabled (Full Preset Speed Mode) 	<p>Direct Access Number — F560</p> <p>Parameter Type — Selection List</p> <p>Factory Default — Disabled</p> <p>Changeable During Run — No</p>

Preset Speed 1 Operation Mode

Program ⇒ Pattern Run ⇒ Operation Mode

This parameter is enabled at F560 and is used to set the speed, torque, and direction of **Preset Speed 1**.

This screen is comprised of 4 fields that are labeled as follows: **Direction**, **Acc/Dec Group**, **V/f Group**, and **Torque Limit Group**. Scroll to the field of interest and press the scroll knob (Enter). Using the scroll knob, set the value and press the scroll knob (Enter).

Parameters F562 – F575 are used to set the functions listed here for **Preset Speeds 2 – 15**.

When using communications write the appropriate byte to location F561 as indicated below.

Settings:

- 0 — Forward Run
- 1 — Reverse Run
- 2 — Accel/Decel Switching 1
- 4 — Accel/Decel Switching 2
- 8 — V/f Switching Signal 1
- 16 — V/f Switching Signal 2
- 32 — Torque Limit Switching Signal 1
- 64 — Torque Limit Switching Signal 2

Writing the following data to location F561 via communications results in: Forward Run, A/D SW 2, V/f SW 3, Torque Lim SW 4.

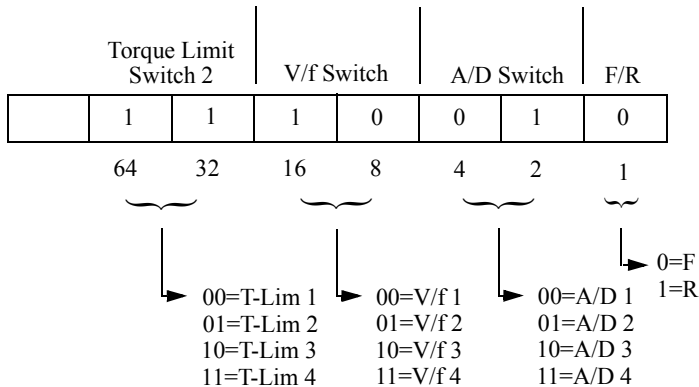

Preset Speed 2 Operation Mode

Program ⇒ Pattern Run ⇒ Operation Mode

Same as **Preset Speed 1 Operation Mode** (see F561).

Direct Access Number — F562

Parameter Type — **Selection List**

Factory Default — **Forward Run**

Changeable During Run — **No**

Preset Speed 3 Operation Mode

Program ⇒ Pattern Run ⇒ Operation Mode

Same as **Preset Speed 1 Operation Mode** (see F561).

Direct Access Number — F563

Parameter Type — **Selection List**

Factory Default — **Forward Run**

Changeable During Run — **No**

<p>Preset Speed 4 Operation Mode</p> <p>Program ⇒ Pattern Run ⇒ Operation Mode</p> <p>Same as Preset Speed 1 Operation Mode (see F561).</p>	<p>Direct Access Number — F564</p> <p>Parameter Type — Selection List</p> <p>Factory Default — Forward Run</p> <p>Changeable During Run — No</p>
<p>Preset Speed 5 Operation Mode</p> <p>Program ⇒ Pattern Run ⇒ Operation Mode</p> <p>Same as Preset Speed 1 Operation Mode (see F561).</p>	<p>Direct Access Number — F565</p> <p>Parameter Type — Selection List</p> <p>Factory Default — Forward Run</p> <p>Changeable During Run — No</p>
<p>Preset Speed 6 Operation Mode</p> <p>Program ⇒ Pattern Run ⇒ Operation Mode</p> <p>Same as Preset Speed 1 Operation Mode (see F561).</p>	<p>Direct Access Number — F566</p> <p>Parameter Type — Selection List</p> <p>Factory Default — Forward Run</p> <p>Changeable During Run — No</p>
<p>Preset Speed 7 Operation Mode</p> <p>Program ⇒ Pattern Run ⇒ Operation Mode</p> <p>Same as Preset Speed 1 Operation Mode (see F561).</p>	<p>Direct Access Number — F567</p> <p>Parameter Type — Selection List</p> <p>Factory Default — Forward Run</p> <p>Changeable During Run — No</p>
<p>Preset Speed 8 Operation Mode</p> <p>Program ⇒ Pattern Run ⇒ Operation Mode</p> <p>Same as Preset Speed 1 Operation Mode (see F561).</p>	<p>Direct Access Number — F568</p> <p>Parameter Type — Selection List</p> <p>Factory Default — Forward Run</p> <p>Changeable During Run — No</p>
<p>Preset Speed 9 Operation Mode</p> <p>Program ⇒ Pattern Run ⇒ Operation Mode</p> <p>Same as Preset Speed 1 Operation Mode (see F561).</p>	<p>Direct Access Number — F569</p> <p>Parameter Type — Selection List</p> <p>Factory Default — Forward Run</p> <p>Changeable During Run — No</p>
<p>Preset Speed 10 Operation Mode</p> <p>Program ⇒ Pattern Run ⇒ Operation Mode</p> <p>Same as Preset Speed 1 Operation Mode (see F561).</p>	<p>Direct Access Number — F570</p> <p>Parameter Type — Selection List</p> <p>Factory Default — Forward Run</p> <p>Changeable During Run — No</p>
<p>Preset Speed 11 Operation Mode</p> <p>Program ⇒ Pattern Run ⇒ Operation Mode</p> <p>Same as Preset Speed 1 Operation Mode (see F561).</p>	<p>Direct Access Number — F571</p> <p>Parameter Type — Selection List</p> <p>Factory Default — Forward Run</p> <p>Changeable During Run — No</p>
<p>Preset Speed 12 Operation Mode</p> <p>Program ⇒ Pattern Run ⇒ Operation Mode</p> <p>Same as Preset Speed 1 Operation Mode (see F561).</p>	<p>Direct Access Number — F572</p> <p>Parameter Type — Selection List</p> <p>Factory Default — Forward Run</p> <p>Changeable During Run — No</p>
<p>Preset Speed 13 Operation Mode</p> <p>Program ⇒ Pattern Run ⇒ Operation Mode</p> <p>Same as Preset Speed 1 Operation Mode (see F561).</p>	<p>Direct Access Number — F573</p> <p>Parameter Type — Selection List</p> <p>Factory Default — Forward Run</p> <p>Changeable During Run — No</p>

<p>Preset Speed 14 Operation Mode Program ⇒ Pattern Run ⇒ Operation Mode</p> <p>Same as Preset Speed 1 Operation Mode (see F561).</p>	<p>Direct Access Number — F574 Parameter Type — Selection List Factory Default — Forward Run Changeable During Run — No</p>
<p>Preset Speed 15 Operation Mode Program ⇒ Pattern Run ⇒ Operation Mode</p> <p>Same as Preset Speed 1 Operation Mode (see F561).</p>	<p>Direct Access Number — F575 Parameter Type — Selection List Factory Default — Forward Run Changeable During Run — No</p>
<p>Motor Overload Protection Level 1 Program ⇒ Fundamental ⇒ Motor Set 1</p> <p>This parameter specifies the motor overload current level for Motor Set 1. This value is entered as either a percentage of the full load rating of the ASD or as a percentage of the FLA of the motor.</p> <p>The unit of measurement for this parameter may be set to A/V (Amps) or it may be set as a percentage of the ASD rating. The nameplated FLA of the motor may be entered directly when Amps is selected as the unit of measurement (see F701 to change the display unit).</p> <p>Motor Overload Protection Level 1 settings will be displayed in Amps if the EOI display units are set to A/V rather than %.</p>	<p>Direct Access Number — F600 Parameter Type — Numerical Factory Default — 100 Changeable During Run — Yes Minimum — 10 Maximum — 100.0 Units — %</p>
<p>Stall Prevention Level Program ⇒ Protection ⇒ Stall</p> <p>This parameter specifies the output current level at which the output frequency is reduced in an attempt to prevent a trip. The over-current level is entered as a percentage of the maximum rating of the drive.</p> <p><i>Note: The Motor Overload Protection parameter must be enabled at F017 to use this feature.</i></p>	<p>Direct Access Number — F601 Parameter Type — Numerical Factory Default — (ASD-Dependent) Changeable During Run — Yes Minimum — 10 Maximum — 165 Units — %</p>
<p>Retain Trip Record at Power Down Program ⇒ Protection ⇒ Trip Settings</p> <p>This parameter Enables/Disables the Trip Record Retention setting. When enabled, this feature logs the trip event and retains the trip information when the system powers down. The trip information may be viewed from the (Program ⇒ Utilities ⇒) Trip History screen or the Monitor screen.</p> <p>When disabled, the trip information will be cleared when the system powers down.</p> <p>Settings:</p> <ul style="list-style-type: none"> 0 — Disabled 1 — Enabled 	<p>Direct Access Number — F602 Parameter Type — Selection List Factory Default — Disabled Changeable During Run — Yes</p>

Emergency Off Mode Settings

Program ⇒ Protection ⇒ Emergency Off Settings

This parameter determines the method used to stop the motor in the event that an **Emergency Off** command is received and the system is configured to use this feature.

This setting may also be associated with the **FL** terminals to allow the **FL** relay to change states when an **EOFF** condition occurs by setting the **FL** terminal to **Fault FL (all)** (see [F132](#)).

***Note:** A supplemental emergency stopping system should be used with the ASD. Emergency stopping should not be a task of the ASD alone.*

Settings:

- 0 — Coast Stop
- 1 — Deceleration Stop
- 2 — DC Injection Braking Stop
- 3 — Deceleration Stop (Decel 4 setting; [F515](#))

Emergency Off DC Injection Application Time

Program ⇒ Protection ⇒ Emergency Off Settings

When **DC Injection** is selected at [F603](#) this parameter determines the time that the **DC Injection Braking** is applied to the motor.

Direct Access Number — F603Parameter Type — **Selection List**Factory Default — **Coast Stop**Changeable During Run — **No**

ASD Output Phase Failure Detection

Program ⇒ Protection ⇒ Phase Loss

This parameter **Enables/Disables** the monitoring of each phase of the 3-phase output signal (U, V, or W) of the ASD. If either line is missing, inactive, or not of the specified level for one second or more, the ASD incurs a trip.

***Note:** Autotune checks for phase failures regardless of this setting.*

Settings:

- 0 — Disabled (No Detection)
- 1 — Enabled (Run at Startup and Retry)
- 2 — Enabled (Every Run Command and Retry)
- 3 — Enabled (During Run)
- 4 — Enabled (At Startup and During Run)
- 5 — Enabled (Detects an ALL-PHASE Failure ONLY - Will Not Trip, Restarts At Reconnect)

Direct Access Number — F604Parameter Type — **Numerical**Factory Default — **1.0**Changeable During Run — **Yes**

Minimum — 0.0

Maximum — 20.0

Units — Seconds

Direct Access Number — F605Parameter Type — **Selection List**Factory Default — **Disabled**Changeable During Run — **No**

<p>Overload Reduction Starting Frequency</p> <p>Program ⇒ Protection ⇒ Overload</p> <p>This parameter is primarily used with V/f motors. It is used to reduce the starting frequency at which the Overload Reduction function begins and is useful during extremely low-speed motor operation.</p> <p>During very low-speed operation the cooling efficiency of the motor decreases. Lowering the start frequency of the Overload Reduction function aides in minimizing the generated heat and precluding an Overload trip.</p> <p>This function is useful in loads such as fans, pumps, and blowers that have the square reduction torque characteristic.</p> <p>Set parameter F607 to the desired Overload Time Limit.</p>	<p>Direct Access Number — F606</p> <p>Parameter Type — Numerical</p> <p>Factory Default — 6.00</p> <p>Changeable During Run — Yes</p> <p>Minimum — 0.00</p> <p>Maximum — 30.00</p> <p>Units — Hz</p>
<p>Motor 150% Overload Time Limit</p> <p>Program ⇒ Protection ⇒ Overload</p> <p>This parameter establishes a time that the motor may operate at 150% of its rated current before tripping. This setting applies the time/150% reference to the individual settings of each motor (e.g., this setting references 150% of the F600 setting for the 1 motor).</p> <p>The unit will trip sooner than the time entered here if the overload is greater than 150%.</p>	<p>Direct Access Number — F607</p> <p>Parameter Type — Numerical</p> <p>Factory Default — 300</p> <p>Changeable During Run — Yes</p> <p>Minimum — 10</p> <p>Maximum — 2400</p> <p>Units — Seconds</p>
<p>ASD Input Phase Failure Detection</p> <p>Program ⇒ Protection ⇒ Phase Loss</p> <p>This parameter enables the 3-phase input power phase loss detection feature. A loss of either input phase (R, S, or T) results in a trip.</p> <p>Settings:</p> <ul style="list-style-type: none"> 0 — Disabled 1 — Enabled 	<p>Direct Access Number — F608</p> <p>Parameter Type — Selection List</p> <p>Factory Default — Enabled</p> <p>Changeable During Run — No</p>
<p>Low-Current Detection Current Hysteresis Width</p> <p>Program ⇒ Protection ⇒ Low-Current Settings</p> <p>During a momentary low-current condition, this parameter provides a current threshold level to which the low-current condition must return within the time setting of F612 or a Low-Current Trip will be incurred.</p>	<p>Direct Access Number — F609</p> <p>Parameter Type — Numerical</p> <p>Factory Default — 10</p> <p>Changeable During Run — Yes</p> <p>Minimum — 1</p> <p>Maximum — 20</p> <p>Units — %</p>
<p>Low-Current Trip</p> <p>Program ⇒ Protection ⇒ Low-Current Settings</p> <p>This parameter Enables/Disables the low-current trip feature.</p> <p>When enabled, the drive will trip on a low-current fault if the output current of the drive falls below the level defined at F611 and remains there for the time set at F612.</p> <p>Settings:</p> <ul style="list-style-type: none"> 0 — Disabled 1 — Enabled 	<p>Direct Access Number — F610</p> <p>Parameter Type — Selection List</p> <p>Factory Default — Disabled</p> <p>Changeable During Run — No</p>

<p>Low-Current Detection Threshold</p> <p>Program ⇒ Protection ⇒ Low-Current Settings</p> <p>With the Low-Current Trip (F610) parameter is enabled, this function sets the low-current trip threshold.</p> <p>The threshold value is entered as a percentage of the maximum rating of the drive.</p>	<p>Direct Access Number — F611</p> <p>Parameter Type — Numerical</p> <p>Factory Default — 0</p> <p>Changeable During Run — Yes</p> <p>Minimum — 0</p> <p>Maximum — 100</p> <p>Units — %</p>
<p>Low-Current Trip Threshold Time</p> <p>Program ⇒ Protection ⇒ Low-current Settings</p> <p>With the Low-Current Trip (F610) parameter is enabled, this function sets the time that the low-current condition must exist to cause a trip.</p>	<p>Direct Access Number — F612</p> <p>Parameter Type — Numerical</p> <p>Factory Default — 0</p> <p>Changeable During Run — Yes</p> <p>Minimum — 0</p> <p>Maximum — 255</p> <p>Units — Seconds</p>
<p>Short Circuit Detection At Start</p> <p>Program ⇒ Protection ⇒ Special Protection Parameters</p> <p>This parameter determines when the system will perform an Output Short Circuit test.</p> <p><i>Note: Selection 3 is recommended for high-speed motor applications. Because of the low impedance of high-speed motors the standard-pulse setting may result in a motor malfunction.</i></p> <p>Settings:</p> <ul style="list-style-type: none"> 0 — Every Start (Standard Pulse) 1 — Power On or Reset (Standard Pulse) 2 — Every Start (Short Pulse) 3 — Power On or Reset (Short Pulse) 	<p>Direct Access Number — F613</p> <p>Parameter Type — Selection List</p> <p>Factory Default — Every Start (Standard Pulse)</p> <p>Changeable During Run — No</p>
<p>Over-Torque Trip</p> <p>Program ⇒ Protection ⇒ Over-Torque Parameters</p> <p>This parameter Enables/Disables the Over-Torque Tripping function.</p> <p>When enabled, the ASD trips if an output torque value greater than the setting of F616 or F617 exists for a time longer than the setting of F618.</p> <p>When disabled, the ASD does not trip due to over-torque conditions.</p> <p><i>Note: A discrete output terminal may be activated when an over-torque alarm occurs if so configured (see F130).</i></p> <p>Settings:</p> <ul style="list-style-type: none"> 0 — Disabled 1 — Enabled 	<p>Direct Access Number — F615</p> <p>Parameter Type — Selection List</p> <p>Factory Default — Disabled</p> <p>Changeable During Run — No</p>

<p>Over-Torque Detection Level (Positive Torque)</p> <p>Program ⇒ Protection ⇒ Over-Torque Parameters</p> <p>This parameter sets the torque threshold level that is used as a setpoint for over-torque tripping during positive torque. This setting is a percentage of the maximum rated torque of the drive.</p> <p>This function is enabled at F615.</p>	<p>Direct Access Number — F616</p> <p>Parameter Type — Numerical</p> <p>Factory Default — 200.00</p> <p>Changeable During Run — No</p> <p>Minimum — 0.00</p> <p>Maximum — 250.00</p> <p>Units — %</p>
<p>Over-Torque Detection Level (Negative Torque)</p> <p>Program ⇒ Protection ⇒ Over-Torque Parameters</p> <p>This parameter sets the torque threshold level that is used as a setpoint for over-torque tripping during negative torque (regen). This setting is a percentage of the maximum rated torque of the drive.</p> <p>This function is enabled at F615.</p>	<p>Direct Access Number — F617</p> <p>Parameter Type — Numerical</p> <p>Factory Default — 200.00</p> <p>Changeable During Run — No</p> <p>Minimum — 0.00</p> <p>Maximum — 250.00</p> <p>Units — %</p>
<p>Over-Torque Detection Time</p> <p>Program ⇒ Protection ⇒ Over-Torque Parameters</p> <p>This parameter sets the amount of time that the over-torque condition may exceed the tripping threshold level set at F616 and F617 before a trip occurs.</p> <p>This function is enabled at F615.</p>	<p>Direct Access Number — F618</p> <p>Parameter Type — Numerical</p> <p>Factory Default — 0.50</p> <p>Changeable During Run — No</p> <p>Minimum — 0.00</p> <p>Maximum — 10.0</p> <p>Units — Seconds</p>
<p>Over-Torque Detection Hysteresis</p> <p>Program ⇒ Protection ⇒ Over-Torque Parameters</p> <p>During a momentary over-torque condition, this parameter provides a torque threshold level to which the over-torque condition must return within the time setting of F618 or an Over-Torque Trip will be incurred.</p>	<p>Direct Access Number — F619</p> <p>Parameter Type — Numerical</p> <p>Factory Default — 10.00</p> <p>Changeable During Run — Yes</p> <p>Minimum — 0.00</p> <p>Maximum — 100.00</p> <p>Units — %</p>
<p>Cooling Fan Control</p> <p>Program ⇒ Protection ⇒ Special Protection Parameters</p> <p>This parameter sets the cooling fan run-time command.</p> <p>Settings:</p> <ul style="list-style-type: none"> 0 — Automatic 1 — Always On 	<p>Direct Access Number — F620</p> <p>Parameter Type — Selection List</p> <p>Factory Default — Automatic</p> <p>Changeable During Run — Yes</p>
<p>Cumulative Operation Time Alarm</p> <p>Program ⇒ Protection ⇒ Special Protection Parameters</p> <p>This parameter sets a run-time value that, once exceeded, closes a discrete output contact. The output signal may be used to control external equipment or used to engage a brake.</p> <p>Associate the Total-Operation-Hours Alarm setting of Table 8 on pg. 239 to a discrete output contactor.</p> <p><i>Note:</i> The time displayed is 1/10th of the actual time (0.1 hr. = 1.0 hr.).</p>	<p>Direct Access Number — F621</p> <p>Parameter Type — Numerical</p> <p>Factory Default — 610.0</p> <p>Changeable During Run — Yes</p> <p>Minimum — 0.0</p> <p>Maximum — 999.9</p> <p>Units — Hours (X 10)</p>

<p>Abnormal Speed Detection Time</p> <p>Program ⇒ Protection ⇒ Abnormal Speed Settings</p> <p>This parameter sets the time that an over-speed condition must exist to cause a trip.</p> <p>This parameter functions in conjunction with the settings of F623 and F624.</p>	<p>Direct Access Number — F622</p> <p>Parameter Type — Numerical</p> <p>Factory Default — 0.01</p> <p>Changeable During Run — Yes</p> <p>Minimum — 0.01</p> <p>Maximum — 100.00</p> <p>Units — Seconds</p>
<p>Over-Speed Detection Frequency Upper Band</p> <p>Program ⇒ Protection ⇒ Abnormal Speed Settings</p> <p>This parameter sets the upper level of the Base Frequency range that, once exceeded, will cause an Over-Speed Detected alert.</p> <p>This parameter functions in conjunction with the settings of F622 and F624.</p>	<p>Direct Access Number — F623</p> <p>Parameter Type — Numerical</p> <p>Factory Default — 0.00 (Disabled)</p> <p>Changeable During Run — Yes</p> <p>Minimum — 0.0 (Disabled)</p> <p>Maximum — 30.00</p> <p>Units — Hz</p>
<p>Over-Speed Detection Frequency Lower Band</p> <p>Program ⇒ Protection ⇒ Abnormal Speed Settings</p> <p>This parameter sets the lower level of the Base Frequency range that, once the output speed falls below this setting, will cause a Speed Drop Detected alert.</p> <p>This parameter functions in conjunction with the settings of F622 and F623.</p>	<p>Direct Access Number — F624</p> <p>Parameter Type — Numerical</p> <p>Factory Default — 0.00 (Disabled)</p> <p>Changeable During Run — Yes</p> <p>Minimum — 0.00 (Disabled)</p> <p>Maximum — 30.00</p> <p>Units — Hz</p>
<p>Over-Voltage Limit Operation Level</p> <p>Program ⇒ Protection ⇒ Stall</p> <p>This parameter sets the upper DC bus voltage threshold that, once exceeded, will cause an Over-Voltage Stall. An Over-Voltage Stall increases the output frequency of the drive during deceleration for a specified time in an attempt to prevent an Over-Voltage Trip.</p> <p>If the over-voltage condition persists for over 4 mS, an Over-Voltage Trip will be incurred.</p> <p>This parameter is enabled at F305.</p> <p><i>Note: This parameter setting may increase deceleration times.</i></p>	<p>Direct Access Number — F626</p> <p>Parameter Type — Numerical</p> <p>Factory Default — (ASD-Dependent)</p> <p>Changeable During Run — Yes</p> <p>Minimum — 100</p> <p>Maximum — 150</p> <p>Units — %</p>
<p>Under-Voltage Trip</p> <p>Program ⇒ Protection ⇒ Under-Voltage/Ridethrough</p> <p>This parameter Enables/Disables the Under-Voltage Trip function.</p> <p>With this parameter Enabled, the ASD will trip if the under-voltage condition persists for a time greater than the F628 setting.</p> <p>A user-selected contact may be actuated if so configured.</p> <p>If Disabled the ASD will stop and not trip; the FL contact is not activated.</p> <p>Settings:</p> <ul style="list-style-type: none"> 0 — Disabled 1 — Enabled 	<p>Direct Access Number — F627</p> <p>Parameter Type — Selection List</p> <p>Factory Default — Disabled</p> <p>Changeable During Run — No</p>

<p>Under-Voltage Trip Detection Time</p> <p>Program ⇒ Protection ⇒ Under-Voltage/Ridethrough</p> <p>This parameter sets the time that the under-voltage condition must exist to cause an Under-Voltage Trip.</p> <p>This parameter is enabled at F627.</p>	<p>Direct Access Number — F628</p> <p>Parameter Type — Numerical</p> <p>Factory Default — 0.03</p> <p>Changeable During Run — No</p> <p>Minimum — 0.01</p> <p>Maximum — 10.00</p> <p>Units — Seconds</p>
<p>Regenerative Power Ridethrough Control Level</p> <p>Program ⇒ Protection ⇒ Under-Voltage/Ridethrough</p> <p>This parameter is activated during regeneration. It is used to set the low end of the DC bus voltage threshold that, once the bus voltage drops below this setting, activates the setting of F302 (Ridethrough Mode).</p> <p>Activation may be the result of a momentary power loss or an excessive load on the bus voltage.</p> <p>During a Ridethrough, regenerative energy is used to maintain the control circuitry settings for the duration of the Ridethrough; it is not used to drive the motor.</p> <p>The motor(s) of the system are stopped and then restarted automatically or may continue seamlessly if so configured.</p> <p>See F302 for more information on this parameter.</p> <p><i>Note:</i> This parameter setting may increase deceleration times.</p>	<p>Direct Access Number — F629</p> <p>Parameter Type — Numerical</p> <p>Factory Default — (ASD-Dependent)</p> <p>Changeable During Run — No</p> <p>Minimum — 55</p> <p>Maximum — 100</p> <p>Units — %</p>
<p>Brake Answer Wait Time</p> <p>Program ⇒ Protection ⇒ Special Protection Parameters</p> <p>This parameter is used in conjunction with the discrete input terminal setting Brake Answerback Input (see Table 5 on pg. 234 for more information on this feature).</p> <p>After activating the discrete input terminal Braking Request, the setting of this parameter starts a count-down timer in which 1) a Brake Answerback Input response must be received or 2) the brake must release before the timer expires.</p> <p>Should this timer setting expire before the Brake Answerback Input is returned or the brake releases, a Brake Fault (E-11) is incurred. Otherwise, the brake releases and normal motor operations resume.</p>	<p>Direct Access Number — F630</p> <p>Parameter Type — Numerical</p> <p>Factory Default — 0.0 (Disabled)</p> <p>Changeable During Run — Yes</p> <p>Minimum — 0.0 (Disabled)</p> <p>Maximum — 10.0</p> <p>Units — Seconds</p>
<p>ASD Overload</p> <p>Program ⇒ Protection ⇒ Overload</p> <p>This parameter is used to protect the ASD from an over-current condition. The standard overload rating of the H9 ASD is 120% operation for 60 seconds.</p> <p>This setting allows for the overload protection to be switched from the standard overload detection means (Thermal Detection <u>and</u> Overload) to thermal detection only.</p> <p>Settings:</p> <ul style="list-style-type: none"> 0 — Thermal Detection + Overload 1 — Thermal Detection Only <p>The Thermal Detection Only selection is used when multiple devices are installed horizontally as described on pg. 15.</p>	<p>Direct Access Number — F631</p> <p>Parameter Type — Selection List</p> <p>Factory Default — Thermal Detection + Overload</p> <p>Changeable During Run — No</p>

<p>V/I Analog Input Broken Wire Detection Level</p> <p>Program ⇒ Terminal ⇒ Input Special Functions</p> <p>This parameter is enabled by providing a non-zero value here. This function monitors the V/I input signal and if the V/I input signal falls below the level specified here and remains there for a period of 0.3 seconds or more a trip will be incurred (E-18).</p> <p>This value is entered as 0% to 100% of the V/I input signal range.</p>	<p>Direct Access Number — F633</p> <p>Parameter Type — Numerical</p> <p>Factory Default — 0 (Disabled)</p> <p>Changeable During Run — No</p> <p>Minimum — 1</p> <p>Maximum — 100</p> <p>Units — %</p>
<p>Annual Average Ambient Temperature</p> <p>Program ⇒ Special ⇒ Special Parameters</p> <p>This parameter is used in conjunction with a discrete output terminal setting to notify the operator of the remaining useful life of critical components of the ASD system.</p> <p>With a discrete output terminal set to Part Replacement Alarm (see Table 8 on pg. 239) and the calculation derived from the parameter setting, maintenance scheduling may be enhanced.</p> <p>Settings:</p> <ul style="list-style-type: none"> 1 — Under 10° C (50° F) 2 — Under 20° C (68° F) 3 — Under 30° C (86° F) 4 — Under 40° C (104° F) 5 — Under 50° C (122° F) 6 — Under 60° C (140° F) 	<p>Direct Access Number — F634</p> <p>Parameter Type — Selection List</p> <p>Factory Default — Under 30°</p> <p>Changeable During Run — No</p>
<p>Rush Relay Current Activation Time</p> <p>Program ⇒ Special ⇒ Special Parameters ⇒ Rush Relay Current Activation Time</p> <p>At system startup, this parameter sets a time-delay for the start of the Rush Relay activation in an attempt to allow the DC bus voltage to reach the normal operating level before outputting a signal to the motor.</p>	<p>Direct Access Number — F635</p> <p>Parameter Type — Numerical</p> <p>Factory Default — 0.0</p> <p>Changeable During Run — No</p> <p>Minimum — 0.0</p> <p>Maximum — 2.5</p> <p>Units — Seconds</p>
<p>PTC1 Thermal Selection</p> <p>Program ⇒ Special ⇒ Special Parameters ⇒ PTC1 Thermal Selection</p> <p>This parameter Enables/Disables the optional external thermal detection circuit of the Expansion IO Card Option 1. A thermistor is connected from TH1+ to TH1- of TB3 on the Expansion IO Card Option 1.</p> <p>Should the thermistor resistance reading fall below 50Ω because of an over-temperature condition or exceed 3000Ω because of an open circuit an External Thermal Fault (OH2) will be incurred.</p> <p><i>Note: While this parameter is Enabled, the system cannot be restarted until the thermistor value recovers to the level of 1.8 kΩ from an over-temperature condition. An Auto-Restart will not be initiated subsequent to an External Thermal Trip (OH2). A manual restart will be required in the event of an OH2 trip.</i></p> <p>Settings:</p> <ul style="list-style-type: none"> 0 — Disabled 1 — Detect Disconnect 	<p>Direct Access Number — F637</p> <p>Parameter Type — Selection List</p> <p>Factory Default — Disabled</p> <p>Changeable During Run — No</p>

<p>PTC2 Thermal Selection</p> <p>Program ⇒ Special ⇒ Special Parameters⇒ PTC2 Thermal Selection</p> <p>This parameter Enables/Disables the optional external thermal detection circuit of the Expansion IO Card Option 2. A thermistor is connected from TH1+ to TH1- of TB4 on the Expansion IO Card Option 2.</p> <p>Should the thermistor resistance reading fall below 50Ω because of an over-temperature condition or exceed 3000Ω because of an open circuit an External Thermal Fault (OH2) will be incurred.</p> <p><i>Note: While this parameter is Enabled, the system cannot be restarted until the thermistor value recovers to the level of 1.8 kΩ from an over-temperature condition. An Auto-Restart will not be initiated subsequent to an External Thermal Trip (OH2). A manual restart will be required in the event of an OH2 trip.</i></p> <p>Settings:</p> <ul style="list-style-type: none"> 0 — Disabled 1 — Detect Disconnect 	<p>Direct Access Number — F638</p> <p>Parameter Type — Selection List</p> <p>Factory Default — Disabled</p> <p>Changeable During Run — No</p>
<p>Braking Resistance Overload Time (10x rated torque)</p> <p>Program ⇒ Protection ⇒ Dynamic Braking</p> <p>This parameter sets the time that the braking resistor is allowed to sustain and overload condition before a trip is incurred.</p> <p>This feature is useful for applications that have a fluctuating load or for loads that require a long deceleration time.</p>	<p>Direct Access Number — F639</p> <p>Parameter Type — Numerical</p> <p>Factory Default — 5.0</p> <p>Changeable During Run — No</p> <p>Minimum — 0.1</p> <p>Maximum — 600.0</p> <p>Units — Seconds</p>
<p>Step-Out Current Detection Level</p> <p>Program ⇒ Motor ⇒ PM Motor</p> <p>This parameter is used with synchronous motor applications only.</p> <p>Contact the TIC Customer Support Center for information on this parameter.</p>	<p>Direct Access Number — F640</p> <p>Parameter Type — Numerical</p> <p>Factory Default — 100</p> <p>Changeable During Run — Yes</p> <p>Minimum — 10</p> <p>Maximum — 150</p> <p>Units — %</p>
<p>Step-Out Current Detection Time</p> <p>Program ⇒ Motor ⇒ PM Motor</p> <p>This parameter is used with synchronous motor applications only.</p> <p>Contact the TIC Customer Support Center for information on this parameter.</p>	<p>Direct Access Number — F641</p> <p>Parameter Type — Numerical</p> <p>Factory Default — 00</p> <p>Changeable During Run — Yes</p> <p>Minimum — 0.00</p> <p>Maximum — 25.0</p> <p>Units — Seconds</p>

Adding Input Selection

Program ⇒ Feedback ⇒ Override Control

This parameter **Enables/Disables** the feature that allows for the external adjustment of the **Output Frequency**.

Selecting either of the input methods listed enables this feature. The selected input is used as a modifier of the programmed **Output Frequency**.

Settings:

- 0 — Disabled
- 1 — V/I
- 2 — RR
- 3 — RX
- 4 — EOI (Keypad)
- 5 — RS485 (2-Wire)
- 6 — RS485 (4-Wire)
- 7 — Communication Option Board
- 8 — RX2 Option (All)
- 9 — Option V/I
- 10 — UP/DOWN Frequency (Terminal Board)
- 11 — Pulse Input (Option)
- 12 — Pulse Input (Motor CPU)
- 13 — Binary/BCD Input (Option)

Direct Access Number — F660Parameter Type — **Selection List**Factory Default — **Disabled**Changeable During Run — **Yes**

Multiplying Input Selection

Program ⇒ Feedback ⇒ Override Control

This parameter **Enables/Disables** the feature that allows for the external adjustment of the commanded frequency.

Selecting either of the input methods listed enables this feature. The selected input is used as a multiplier of the commanded frequency.

If **Setting (F729)** is selected, the % value entered at parameter **F729** is used as the multiplier of the commanded frequency.

Settings:

- 0 — Disabled
- 1 — V/I
- 2 — RR
- 3 — RX
- 4 — Setting (**F729**)
- 5 — RX2 Option (All)

Direct Access Number — F661Parameter Type — **Selection List**Factory Default — **Disabled**Changeable During Run — **No**

AM Output Terminal Function

Program ⇒ Terminal ⇒ Analog Output Terminals

This parameter is used to set the output function of the **AM** analog output terminal. The **AM** analog output terminal produces an output current that is proportional to the magnitude of the function assigned to this terminal. The available assignments for this output terminal are listed in [Table 6 on pg. 237](#).

Note: To read **current** at this terminal connect a 100 – 500Ω resistor from the **AM (+)** terminal through the series Ammeter to the **CC (-)** terminal.

AM Terminal Setup Parameters

- F670 — Set AM Function
- F671 — Calibrate AM Terminal
- F685 — Output Response Polarity Selection
- F686 — Set Zero Level

Direct Access Number — F670

Parameter Type — Selection List

Factory Default — Output Current

Changeable During Run — Yes

AM Output Terminal Adjustment

Program ⇒ Terminal ⇒ Analog Output Terminals

This parameter is used to calibrate the **AM** analog output.

To calibrate the **AM** analog output, connect an ammeter as described at parameter [F670](#).

With the drive is running at a known value (e.g., output frequency), adjust this parameter until the associated function of parameter [F670](#) produces the desired DC level output at the **AM** output terminal.

See [F670](#) for more information on this setting.

Direct Access Number — F671

Parameter Type — Numerical

Factory Default — 512

Changeable During Run — Yes

Minimum — 1

Maximum — 1280

MON1 Terminal Meter Selection

Program ⇒ Terminal ⇒ Analog Output Terminals

This parameter is used to set the output function of the **MON1** analog output terminal. The available assignments for this output terminal are listed in [Table 6 on pg. 237](#).

The **MON1** analog output terminal produces an output voltage or current that is proportional to the magnitude of the function assigned to this terminal.

Note: The **Expansion IO Card Option 2** option board (P/N ETB004Z) is required to use this terminal.

See the **Expansion IO Card Option 2** instruction manual (P/N 58686) for more information on the function of this terminal.

MON1 Terminal Setup Parameters

- F672 — MON1 Output Function
- F673 — MON1 Terminal Meter Adjustment
- F688 — MON1 Voltage/Current Output Switching
- F689 — MON1 Output Gradient Characteristic
- F690 — MON1 Bias Adjustment Set Zero Level

Direct Access Number — F672

Parameter Type — Selection List

Factory Default — Output Voltage

Changeable During Run — Yes

MON1 Terminal Adjustment

Program ⇒ Terminal ⇒ Analog Output Terminals

This parameter is used to set the gain of the **MON1** output terminal and is used in conjunction with the settings of parameter [F672](#).

See parameter [F672](#) for more information on this setting.

Direct Access Number — F673

Parameter Type — **Numerical**

Factory Default — **512**

Changeable During Run — **Yes**

Minimum — 1

Maximum — 1280

MON2 Terminal Meter Selection

Program ⇒ Terminal ⇒ Analog Output Terminals

This parameter is used to set the output function of the **MON2** analog output terminal. The available assignments for this output terminal are listed in [Table 6 on pg. 237](#).

The **MON2** analog output terminal produces an output voltage or current that is proportional to the magnitude of the function assigned to this terminal.

Note: The **Expansion IO Card Option 2** option board (P/N ETB004Z) is required to use this terminal.

See the **Expansion IO Card Option 2** instruction manual (P/N 58686) for more information on the function of this terminal.

Direct Access Number — F674

Parameter Type — **Selection List**

Factory Default — **Output Frequency**

Changeable During Run — **Yes**

MON2 Terminal Setup Parameters

[F674](#) — MON2 Output Function

[F675](#) — MON2 Terminal Meter Adjustment

[F691](#) — MON2 Voltage/Current Output Switching

[F692](#) — MON2 Output Gradient Characteristic

[F693](#) — MON2 Bias Adjustment Set Zero Level

MON2 Terminal Adjustment

Program ⇒ Terminal ⇒ Analog Output Terminals

This parameter is used to set the gain of the **MON2** output terminal and is used in conjunction with the settings of parameter [F674](#).

See parameter [F674](#) for more information on this setting.

Direct Access Number — F675

Parameter Type — **Numerical**

Factory Default — **512**

Changeable During Run — **Yes**

Minimum — 1

Maximum — 1280

FP Terminal Assignment

Program ⇒ Terminal ⇒ Analog Output Terminals

This parameter sets the functionality of the **FP** output terminal to any one of the user-selectable functions listed in [Table 6 on pg. 237](#) and is enabled at parameter [F669](#).

As the assigned function changes in magnitude or frequency, the pulse count of the **FP** output terminal pulse train changes in direct proportion to changes in the assigned function.

Note: The duty cycle of the output pulse train remains at $65 \pm 5.0 \mu\text{S}$.

This parameter is used in conjunction with parameter [F677](#).

Direct Access Number — F676

Parameter Type — **Selection List**

Factory Default — **Output Frequency**

Changeable During Run — **Yes**

<p>Pulse Output Frequency</p> <p>Program ⇒ Terminal ⇒ Analog Output Terminals</p> <p>This parameter scales the FP output terminal by setting the pulses-per-second output signal of the FP terminal.</p> <p>See F676 for more information on this parameter.</p>	<p>Direct Access Number — F677</p> <p>Parameter Type — Numerical</p> <p>Factory Default — 3.84</p> <p>Changeable During Run — Yes</p> <p>Minimum — 1.00</p> <p>Maximum — 43.20</p> <p>Units — Pulses/Second</p>
<p>FM Voltage/Current Output Switching</p> <p>Program ⇒ Terminal ⇒ Analog Output Terminals</p> <p>This parameter is used to select the type of output signal provided at the FM terminal (i.e., voltage or current).</p> <p>The output voltage and current range is 0 – 10 VDC and 0 – 20 mA, respectively.</p> <p>See F005 for more information on this setting.</p> <p>Settings:</p> <ul style="list-style-type: none"> 0 — 0 – 10 V 1 — 0 – 20 mA 	<p>Direct Access Number — F681</p> <p>Parameter Type — Selection List</p> <p>Factory Default — 0–10V</p> <p>Changeable During Run — No</p>
<p>FM Output Gradient Characteristic</p> <p>Program ⇒ Terminal ⇒ Analog Output Terminals</p> <p>This parameter sets the output response polarity of the FM output terminal. The FM output terminal response may be set to respond inversely (-) or directly (+) to the input signal.</p> <p>See F005 for more information on this setting.</p> <p>Settings:</p> <ul style="list-style-type: none"> 0 — Minus (Negative Gradient) 1 — Plus (Positive Gradient) 	<p>Direct Access Number — F682</p> <p>Parameter Type — Selection List</p> <p>Factory Default — Plus</p> <p>Changeable During Run — Yes</p>
<p>FM Bias Adjustment</p> <p>Program ⇒ Terminal ⇒ Analog Output Terminals</p> <p>This parameter setting is used to ensure that a zero-level input signal produces a zero-level output at the FM terminal.</p> <p>Set the function of F005 to zero and then set this parameter to zero for proper operation.</p> <p>See F005 for more information on this setting.</p>	<p>Direct Access Number — F683</p> <p>Parameter Type — Numerical</p> <p>Factory Default — 0.0</p> <p>Changeable During Run — Yes</p> <p>Minimum — -10.0</p> <p>Maximum — +100.0</p> <p>Units — %</p>
<p>AM Output Gradient Characteristic</p> <p>Program ⇒ Terminal ⇒ Analog Output Terminals</p> <p>This parameter sets the output response polarity of the AM output terminal.</p> <p>The AM output terminal response may be set to respond inversely (-) or directly (+) to the input signal.</p> <p>See F670 for more information on this setting.</p> <p>Settings:</p> <ul style="list-style-type: none"> 0 — Minus (Negative Gradient) 1 — Plus (Positive Gradient) 	<p>Direct Access Number — F685</p> <p>Parameter Type — Selection List</p> <p>Factory Default — Plus</p> <p>Changeable During Run — Yes</p>

<p>AM Bias Adjustment</p> <p>Program ⇒ Terminal ⇒ Analog Output Terminals</p> <p>This parameter setting is used to ensure that a zero-level input signal produces a zero-level output at the AM terminal.</p> <p>Set the function set at F670 to zero and then set this parameter to zero for proper operation.</p> <p>See F670 for more information on this setting.</p>	<p>Direct Access Number — F686</p> <p>Parameter Type — Numerical</p> <p>Factory Default — 0.0</p> <p>Changeable During Run — Yes</p> <p>Minimum — -10.0</p> <p>Maximum — +100.0</p> <p>Units — %</p>
<p>MON 1 Voltage/Current Output Switching</p> <p>Program ⇒ Terminal ⇒ Analog Output Terminals</p> <p>This parameter is used to set the output signal type of the MON1 output terminal.</p> <p>Settings</p> <ul style="list-style-type: none"> 0 — -10 V – +10 V 1 — 0 – 10 V 2 — 0 – 20 mA 	<p>Direct Access Number — F688</p> <p>Parameter Type — Selection List</p> <p>Factory Default — 0 – 10V</p> <p>Changeable During Run — Yes</p>
<p>MON 1 Output Gradient Characteristic</p> <p>Program ⇒ Terminal ⇒ Analog Output Terminals</p> <p>This parameter sets the output response polarity of the MON1 output terminal. The MON1 output terminal response may be set to respond inversely (-) or directly (+) to the input signal.</p> <p>See parameter F672 for more information on this setting.</p> <p>Settings:</p> <ul style="list-style-type: none"> 0 — Minus (Negative Gradient) 1 — Plus (Positive Gradient) 	<p>Direct Access Number — F689</p> <p>Parameter Type — Selection List</p> <p>Factory Default — Plus</p> <p>Changeable During Run — Yes</p>
<p>MON 1 Bias Adjustment</p> <p>Program ⇒ Terminal ⇒ Analog Output Terminals</p> <p>This parameter setting is used to ensure that a zero-level input signal produces a zero-level output at the MON1 terminal.</p> <p>Set the assigned function of parameter F672 to zero and then set this parameter to a zero output.</p> <p>See parameter F672 for more information on this setting.</p>	<p>Direct Access Number — F690</p> <p>Parameter Type — Numerical</p> <p>Factory Default — 0.0</p> <p>Changeable During Run — Yes</p> <p>Minimum — -10.0</p> <p>Maximum — 100.0</p> <p>Units — %</p>
<p>MON 2 Voltage/Current Output Switching</p> <p>Program ⇒ Terminal ⇒ Analog Output Terminals</p> <p>This parameter is used to set the output signal type of the MON2 output terminal.</p> <p>See parameter F674 for more information on this setting.</p> <p>Settings</p> <ul style="list-style-type: none"> 0 — -10 V – +10 V 1 — 0 – 10 V 2 — 0 – 20 mA 	<p>Direct Access Number — F691</p> <p>Parameter Type — Selection List</p> <p>Factory Default — 0 – 10V</p> <p>Changeable During Run — Yes</p>

<p>MON 2 Output Gradient Characteristic</p> <p>Program ⇒ Terminal ⇒ Analog Output Terminals</p> <p>This parameter sets the output response polarity of the MON2 output terminal. The MON2 output terminal response may be set to respond inversely (-) or directly (+) to the input signal.</p> <p>See parameter F672 for more information on this setting.</p> <p>Settings:</p> <ul style="list-style-type: none"> 0 — Minus (Negative Gradient) 1 — Plus (Positive Gradient) 	<p>Direct Access Number — F692</p> <p>Parameter Type — Selection List</p> <p>Factory Default — Plus</p> <p>Changeable During Run — Yes</p>
<p>MON 2 Bias Adjustment</p> <p>Program ⇒ Terminal ⇒ Analog Output Terminals</p> <p>This parameter setting is used to ensure that a zero-level input signal produces a zero-level output at the MON2 terminal.</p> <p>Set the assigned function of parameter F674 to zero and then set this parameter to a zero output.</p> <p>See parameter F674 for more information on this setting.</p>	<p>Direct Access Number — F693</p> <p>Parameter Type — Numerical</p> <p>Factory Default — 0.0</p> <p>Changeable During Run — Yes</p> <p>Minimum — -10.0</p> <p>Maximum — 100.0</p> <p>Units — %</p>
<p>Parameter Write Lock Out</p> <p>Program ⇒ Utilities ⇒ Prohibition</p> <p>This parameter Enables/Disables the Run and Stop keys.</p> <p>Settings:</p> <ul style="list-style-type: none"> 0 — Enabled 1 — Disabled 	<p>Direct Access Number — F700</p> <p>Parameter Type — Selection List</p> <p>Factory Default — Enabled</p> <p>Changeable During Run — Yes</p>
<p>Display Units for Voltage and Current</p> <p>Program ⇒ Utilities ⇒ Display Parameters</p> <p>This parameter sets the unit of measurement for current and voltage values displayed on the EOI.</p> <p>Settings:</p> <ul style="list-style-type: none"> 0 — % 1 — A/V 	<p>Direct Access Number — F701</p> <p>Parameter Type — Selection List</p> <p>Factory Default — %</p> <p>Changeable During Run — Yes</p>
<p>Display Unit Multiplication Factor</p> <p>Program ⇒ Utilities ⇒ Display Parameters</p> <p>This parameter provides a multiplier for the displayed speed value shown on the EOI of the ASD.</p> <p>This parameter may be used to display the rate that a commodity is being processed by the driven load in process units (i.e., units/time).</p> <p>Example: <i>An output frequency of 100 Hz would be displayed as 50 Hz if using a multiplier of 0.5 for this parameter.</i></p> <p>Note: <i>PID frequency-limiting parameters are not affected by this setting (i.e., F364, F365, F367, and F368).</i></p>	<p>Direct Access Number — F702</p> <p>Parameter Type — Numerical</p> <p>Factory Default — 0.00 (OFF)</p> <p>Changeable During Run — Yes</p> <p>Minimum — 0.00</p> <p>Maximum — 200.00</p>

Display Unit Selection

Program ⇒ Utilities ⇒ Display Parameters

This parameter is used in conjunction with [F702](#) to set the method in which the frequency is displayed on the EOI.

The multiplier setting of [F702](#) will be applied to the display of all frequencies if all frequencies are selected at this parameter.

The multiplier setting of [F702](#) will be applied to parameters [F364](#), [F365](#), [F367](#), and [F368](#) ONLY if **PID Process Data** is selected at this parameter.

Settings:

- 0 — All Frequencies
- 1 — PID Process Data

Display Gradient Characteristic

Program ⇒ Utilities ⇒ Display Parameters

The ASD-displayed response to output speed changes will be displayed as directly proportional or inversely proportional as a function of this parameter setting.

Selecting **Negative Gradient** displays an increased output speed as going more negative.

Selecting **Positive Gradient** displays an increased output speed as going more positive.

Settings:

- 0 — Minus (Negative Gradient)
- 1 — Plus (Positive Gradient)

Display Bias

Program ⇒ Utilities ⇒ Display Parameters

In conjunction with the setting of [F702](#), this parameter sets the bias of the EOI speed display.

The frequency entered here will be multiplied by the setting of [F702](#) and then displayed as the zero value on the EOI.

Change Step Selection 1

Program ⇒ Utilities ⇒ Display Parameters

In conjunction with the parameter setting of [F708](#), this parameter sets the amount that the output speed will increase or decrease for each speed command change entered from the EOI using the **Rotary Encoder**.

Direct Access Number — F703Parameter Type — **Selection List**Factory Default — **All Frequencies**Changeable During Run — **Yes**

Direct Access Number — F705Parameter Type — **Selection List**Factory Default — **Plus**Changeable During Run — **Yes**

Direct Access Number — F706Parameter Type — **Numerical**Factory Default — **0.00**Changeable During Run — **Yes**

Minimum — 0.00

Maximum — **Max. Freq. (F011)**

Units — Hz

Direct Access Number — F707Parameter Type — **Numerical**Factory Default — **0.00**Changeable During Run — **Yes**

Minimum — 0.00

Maximum — **Max. Freq. (F011)**

Units — Hz

Change Step Selection 2

Program ⇒ Utilities ⇒ Display Parameters

The parameter is used to modify the degree that the setting of **F707** affects the output speed changes that are input from the EOI using the **Rotary Encoder**.

Selecting a zero value here disables this parameter and the resulting non-zero value of parameter setting **F707** is output from the ASD.

Selecting a non-zero value here provides a dividend that will be used in the following equation resulting in the actual output frequency applied to the motor.

$$\text{OutputFrequencyDisplayed} = \text{InternallyCommandedFrequency} \times \frac{\text{F708}}{\text{F707}}$$

Direct Access Number — F708

Parameter Type — Numerical

Factory Default — 0 (Disabled)

Changeable During Run — Yes

Minimum — 0

Maximum — 255

Operation Command Clear Selection When ST Off

Program ⇒ Special ⇒ Operation Panel Parameters

Upon deactivation of the **ST** terminal while operating in the **Local** mode, the ASD output to the motor will cease— this parameter setting is used to allow for the reactivation of the motor without user intervention upon the reactivation of the **ST** terminal.

Upon reactivation of the **ST** terminal in this condition the ASD will resume the Run condition and the motor will start (1 — Retain Run Command).

This feature may be **Disabled** and the Run command must be re-initiated by the user for ASD operation (0 — Clear Panel Run Command).

Direct Access Number — F719

Parameter Type — Selection List

Factory Default — Retain Panel Run Command

Changeable During Run — Yes



WHEN ENABLED THE ASD WILL RESUME THE RUN CONDITION WHEN THE ST TERMINAL IS REACTIVATED.

Settings:

0 — Clear Panel Run Command

1 — Retain Panel Run Command

Panel Stop Pattern

Program ⇒ Special ⇒ Operation Panel Parameters

While operating in the **Local** mode this parameter determines the method used to stop the motor when the stop command is issued via the EOI.

The **Decel Stop** setting enables the **Dynamic Braking** system that is setup at **F304** or the **DC Injection Braking** system that is setup at **F250**, **F251**, and **F252**.

The **Coast Stop** setting allows the motor to stop at the rate allowed by the inertia of the load.

Settings:

0 — Deceleration Stop

1 — Coast Stop

Note: *The **Stop Pattern** setting has no effect on the **Emergency Off** settings of **F603**. This parameter may also be accessed by pressing the **ESC** key from the **Frequency Command** screen.*

Direct Access Number — F721

Parameter Type — Selection List

Factory Default — Deceleration Stop

Changeable During Run — Yes

<p>Panel Torque Command</p> <p>Program ⇒ Special ⇒ Operation Panel Parameters</p> <p>This function is not used with the H9 ASD.</p> <p>The Torque Command selection is performed at F420.</p>	<p>Direct Access Number — F725</p> <p>Parameter Type — Numerical</p> <p>Factory Default — 0.00</p> <p>Changeable During Run — Yes</p> <p>Minimum — -250.00</p> <p>Maximum — +250.00</p>
<p>Panel Tension Torque Bias</p> <p>Program ⇒ Special ⇒ Operation Panel Parameters</p> <p>This function is not used with the H9 ASD.</p> <p>The Tension Torque Bias selection is performed at F423.</p>	<p>Direct Access Number — F727</p> <p>Parameter Type — Numerical</p> <p>Factory Default — 0.00</p> <p>Changeable During Run — Yes</p> <p>Minimum — -250.00</p> <p>Maximum — +250.00</p> <p>Units — %</p>
<p>Panel Load Sharing Gain</p> <p>Program ⇒ Special ⇒ Operation Panel Parameters</p> <p>This function is not used with the H9 ASD.</p> <p>The Load Sharing Gain selection is performed at F424.</p>	<p>Direct Access Number — F728</p> <p>Parameter Type — Numerical</p> <p>Factory Default — 100.00</p> <p>Changeable During Run — Yes</p> <p>Minimum — 0.00</p> <p>Maximum — 250.00</p> <p>Units — %</p>
<p>Panel Override Multiplication Gain</p> <p>Program ⇒ Special ⇒ Operation Panel Parameters</p> <p>This parameter provides a value to be used in the event that Setting (F729) is selected for the Frequency Override Multiplying Input (F661).</p>	<p>Direct Access Number — F729</p> <p>Parameter Type — Numerical</p> <p>Factory Default — 0.00</p> <p>Changeable During Run — Yes</p> <p>Minimum — -100.00</p> <p>Maximum — 100.00</p> <p>Units — %</p>
<p>Panel Frequency Lock Out</p> <p>Program ⇒ Special ⇒ Operation Panel Parameters</p> <p>This parameter is model-specific and has no function on the H9 ASD system.</p> <p>Settings:</p> <ul style="list-style-type: none"> 0 — Unlocked 1 — Locked 	<p>Direct Access Number — F730</p> <p>Parameter Type — Selection List</p> <p>Factory Default — Unlocked</p> <p>Changeable During Run — Yes</p>
<p>Panel Emergency Off Lock Out</p> <p>Program ⇒ Special ⇒ Operation Panel Parameters</p> <p>This parameter is model-specific and has no function on the H9 ASD system.</p> <p>Settings:</p> <ul style="list-style-type: none"> 0 — Unlocked 1 — Locked 	<p>Direct Access Number — F734</p> <p>Parameter Type — Selection List</p> <p>Factory Default — Unlocked</p> <p>Changeable During Run — No</p>

<p>Panel Reset Lock Out</p> <p>Program ⇒ Special ⇒ Operation Panel Parameters</p> <p>This parameter is model-specific and has no function on the H9 ASD system.</p> <p>Settings:</p> <ul style="list-style-type: none"> 0 — Unlocked 1 — Locked 	<p>Direct Access Number — F735</p> <p>Parameter Type — Selection List</p> <p>Factory Default — Unlocked</p> <p>Changeable During Run — Yes</p>
<p>Command Mode/Frequency Mode Change Lock Out</p> <p>Program ⇒ Utilities ⇒ Prohibition</p> <p>This parameter is model-specific and has no function on the H9 ASD system.</p> <p>Settings:</p> <ul style="list-style-type: none"> 0 — Unlocked 1 — Locked 	<p>Direct Access Number — F736</p> <p>Parameter Type — Selection List</p> <p>Factory Default — Locked</p> <p>Changeable During Run — Yes</p>
<p>Lock Out All Keys</p> <p>Program ⇒ Utilities ⇒ Prohibition</p> <p>This parameter is model-specific and has no function on the H9 ASD system.</p> <p>Settings:</p> <ul style="list-style-type: none"> 0 — Unlocked 1 — Locked 	<p>Direct Access Number — F737</p> <p>Parameter Type — Selection List</p> <p>Factory Default — Unlocked</p> <p>Changeable During Run — Yes</p>
<p>Trace Selection</p> <p>Program ⇒ Utilities ⇒ Trace</p> <p>In conjunction with parameter F741 – F745, this parameter is used to monitor and store 4 ASD output waveform data points. The data may be read and stored as a function of a trip (At Trip) or it may be initiated by the activation of a discrete terminal activation (At Trigger).</p> <p>Set a discrete input terminal to Trace Back Trigger Signal and activate the terminal to initiate the At Trigger read/store function.</p> <p>Table 9 on pg. 240 lists the items that may be selected for the data read/store function along with the associated communication number for each selection.</p> <p>The duration of the read/store cycle for the selected items is set at parameter F741.</p> <p>To acquire and store the data a communications device and a PC are required. The H9 ASD supports the following communications protocols: RS485 (MODBUS-RTU) Toshiba Protocol, USB Toshiba Protocol, CC-Link, ProfiBus, and DeviceNet (Refer to the manual of each protocol type for more information).</p> <p>Trace data may be viewed graphically via Program ⇒ Utilities ⇒ View Trace Data.</p> <p>Settings:</p> <ul style="list-style-type: none"> 0 — None (Disabled) 1 — At Trip 2 — At Trigger 	<p>Direct Access Number — F740</p> <p>Parameter Type — Selection List</p> <p>Factory Default — At Trip</p> <p>Changeable During Run — Yes</p>

<p>Trace Cycle</p> <p>Program ⇒ Utilities ⇒ Trace</p> <p>This parameter sets the record time for the Trace Data events selected at F742 – F745.</p> <p>See F740 for more information on this parameter setting.</p> <p>Settings:</p> <ul style="list-style-type: none"> 0 — 4 mS 1 — 20 mS 2 — 100 mS 3 — 1 Second 4 — 10 Seconds 	<p>Direct Access Number — F741</p> <p>Parameter Type — Selection List</p> <p>Factory Default — 100 mS</p> <p>Changeable During Run — Yes</p>
<p>Trace Data 1</p> <p>Program ⇒ Utilities ⇒ Trace</p> <p>This parameter is used to select the Trace Data 1 item from Table 9 on pg. 240 to be read and stored in accordance with the setup of parameters F740 and F741.</p> <p>See F740 for more information on this parameter setting.</p>	<p>Direct Access Number — F742</p> <p>Parameter Type — Selection List</p> <p>Factory Default — Output Frequency</p> <p>Changeable During Run — Yes</p>
<p>Trace Data 2</p> <p>Program ⇒ Utilities ⇒ Trace</p> <p>This parameter is used to select the Trace Data 2 item from Table 9 on pg. 240 to be read and stored in accordance with the setup of parameters F740 and F741.</p> <p>See F740 for more information on this parameter setting.</p>	<p>Direct Access Number — F743</p> <p>Parameter Type — Selection List</p> <p>Factory Default — Freq. Reference</p> <p>Changeable During Run — Yes</p>
<p>Trace Data 3</p> <p>Program ⇒ Utilities ⇒ Trace</p> <p>This parameter is used to select the Trace Data 3 item from Table 9 on pg. 240 to be read and stored in accordance with the setup of parameters F740 and F741.</p> <p>See F740 for more information on this parameter setting.</p>	<p>Direct Access Number — F744</p> <p>Parameter Type — Selection List</p> <p>Factory Default — Output Current</p> <p>Changeable During Run — Yes</p>
<p>Trace Data 4</p> <p>Program ⇒ Utilities ⇒ Trace</p> <p>This parameter is used to select the Trace Data 4 item from Table 9 on pg. 240 to be read and stored in accordance with the setup of parameters F740 and F741.</p> <p>See F740 for more information on this parameter setting.</p>	<p>Direct Access Number — F745</p> <p>Parameter Type — Selection List</p> <p>Factory Default — DC Voltage</p> <p>Changeable During Run — Yes</p>

<p>Baud Rate (RS485 2-Wire)</p> <p>Program ⇒ Communications ⇒ Communication Settings</p> <p>This parameter plays a role in the setup of the communications network by establishing the Baud Rate of the communications link.</p> <p>The communications network includes other ASDs and Host/Control computers that monitor the status of the ASD(s), transfers commands, and loads or modifies the parameter settings of the ASD.</p> <p>Changes made to this parameter require that the power be cycled (off then on) for the changes to take effect.</p> <p>Settings:</p> <ul style="list-style-type: none"> 0 — 9600 1 — 19200 2 — 38400 	<p>Direct Access Number — F800</p> <p>Parameter Type — Selection List</p> <p>Factory Default — 19200</p> <p>Changeable During Run — Yes</p> <p>Units — bps</p>
<p>Parity (RS485 2- and 4-Wire)</p> <p>Program ⇒ Communications ⇒ Communication Settings</p> <p>This parameter plays a role in the setup of the communications network by establishing the Parity setting of the communications link.</p> <p>The communications network includes other ASDs and Host/Control computers that monitor the status of the ASD(s), transfers commands, and loads or modifies the parameter settings of the ASD.</p> <p>Changes made to this parameter require that the power be cycled (off then on) for the changes to take effect.</p> <p>Settings:</p> <ul style="list-style-type: none"> 0 — No Parity 1 — Even Parity 2 — Odd Parity 	<p>Direct Access Number — F801</p> <p>Parameter Type — Selection List</p> <p>Factory Default — Even Parity</p> <p>Changeable During Run — Yes</p>
<p>ASD Number</p> <p>Program ⇒ Communications ⇒ Communication Settings</p> <p>This parameter plays a role in the setup of the communications network by assigning an identification (ID) number to each ASD in the communications network.</p> <p>The communications network includes other ASDs and Host/Control computers that monitor the status of the ASD(s), transfers commands, and loads or modifies the parameter settings of the ASD.</p> <p>Changes made to this parameter require that the power be cycled (off then on) for the changes to take effect.</p>	<p>Direct Access Number — F802</p> <p>Parameter Type — Numerical</p> <p>Factory Default — 0</p> <p>Changeable During Run — Yes</p> <p>Minimum — 0</p> <p>Maximum — 247</p>
<p>Communications Time-Out Time (RS485 2- and 4-wire)</p> <p>Program ⇒ Communications ⇒ Communication Settings</p> <p>This parameter plays a role in the setup of the communications network by setting the time that no activity may exist over the communications link before the link is severed (Time Out).</p> <p>The communications network includes other ASDs and Host/Control computers that monitor the status of the ASD(s), transfers commands, and loads or modifies the parameter settings of the ASD.</p> <p>Changes made to this parameter require that the power be cycled (off then on) for the changes to take effect.</p>	<p>Direct Access Number — F803</p> <p>Parameter Type — Numerical</p> <p>Factory Default — 0 (Off)</p> <p>Changeable During Run — Yes</p> <p>Minimum — 0 (Off)</p> <p>Maximum — 100</p> <p>Units — Seconds</p>

Communications Time-Out Action (RS485 2- and 4-wire)

Program ⇒ Communications ⇒ Communication Settings

This parameter plays a role in the setup of the communications network by determining the action to be taken in the event of a time-out (Time-Out Action).

The communications network includes other ASDs and Host/Control computers that monitor the status of the ASD(s), transfers commands, and loads or modifies the parameter settings of the drive.

Changes made to this parameter require that the power be cycled (off then on) for the changes to take effect.

Settings:

(Settings Are For 2-Wire/4-Wire)

- 0 — No Action/No Action
- 1 — Alarm/No Action
- 2 — Trip/No Action
- 3 — No Action/Alarm
- 4 — Alarm/Alarm
- 5 — Trip/Alarm
- 6 — No Action/Trip
- 7 — Alarm/Trip
- 8 — Trip/Trip

Direct Access Number — F804

Parameter Type — **Selection List**

Factory Default — **Trip/Trip**

Changeable During Run — **Yes**

Send Wait Time (RS485 2-wire)

Program ⇒ Communications ⇒ Communication Settings

This parameter sets the **RS485** (2-wire) response delay time.

Changes made to this parameter require that the power be cycled (off then on) for the changes to take effect.

Direct Access Number — F805

Parameter Type — **Numerical**

Factory Default — **0.00**

Changeable During Run — **Yes**

Minimum — 0.00

Maximum — 2.00

Units — Seconds

ASD-to-ASD Communications (RS485 2-wire)

Program ⇒ Communications ⇒ Communication Settings

The function of this parameter is 2-fold:

- 1) In a Master/Follower configuration and while communicating via RS485 2-wire, this parameter sets the ASD as the Master or the Follower.
- 2) This parameter determines the function of the ASD while operating as the Master or the Follower. If operating as the Master ASD, an output parameter of the Master ASD is used to control the Follower ASDs and is set here.

If operating as a Follower ASD, the ASD response if an error is incurred is set here.

Note: *Select a Follower function here if F826 is configured as a **Master Output** controller for any other ASD in the system. Otherwise, an **EOI** failure will result.*

Changes made to this parameter require that the power be cycled (off then on) for the changes to take effect.

Settings:

- 0 — Follower (Decel Stop If Error Detected)
- 1 — Follower (Continues Operation If Error Detected)
- 2 — Follower (Emergency Off If Error Detected)
- 3 — Master (Frequency Command)
- 4 — Master (Output Frequency)
- 5 — Master (Torque Reference)
- 6 — Master (Torque Command)

Direct Access Number — F806

Parameter Type — Selection List

Factory Default — Follower (Decel Stop)

Changeable During Run — Yes

RS485 2-Wire Protocol Selection

Program ⇒ Communications ⇒ Communication Reference Adjust

This parameter sets the **RS485** (2-wire) communications protocol.

Settings:

- 0 — Toshiba
- 1 — Modbus

Direct Access Number — F807

Parameter Type — Selection List

Factory Default — Toshiba

Changeable During Run — Yes

Frequency Point Selection

Program ⇒ Communications ⇒ Communication Reference Adjust

This parameter is used to set the communications reference for scaling.

See [F811](#) — [F814](#) for more information on this setting.

Note: *Scaling the communications signal is not required for all applications.*

Changes made to this parameter require that the power be cycled (off then on) for the changes to take effect.

Settings:

- 0 — Disabled
- 1 — RS485 (2-Wire — NOT USED)
- 2 — RS485 (4-Wire)
- 3 — Communication Card

Direct Access Number — F810

Parameter Type — Selection List

Factory Default — Disabled

Changeable During Run — Yes

Point 1 Setting

Program ⇒ Communications ⇒ Communication Reference Adjust

When enabled at F810, this parameter is used to allow the user to set the gain and bias of the speed control input to the drive when the speed control signal is received via the source selected at F810.

Gain and Bias Settings

When operating in the **Speed Control** mode and using one of the control sources from **Settings** above, the settings that determine the gain and bias properties of the input signal are:

- **Communications Reference Speed Setpoint 1** (frequency) (F812),
- the communications input signal value that represents **Communications Reference Speed Setpoint 1** (frequency): F811,
- **Communications Reference Speed Setpoint 2** (frequency) (F814), and
- the communications input signal value that represents **Communications Reference Speed Setpoint 2** (frequency): F813.

Once set, as the input signal value changes, the output frequency of the drive will vary in accordance with the above settings.

This parameter sets the **Communications Reference** input value that represents **Communications Reference Speed Setpoint 1** (frequency). This value is entered as 0 to 100% of the **Communications Reference** input value range.

Changes made to this parameter require that the power be cycled (off then on) for the changes to take effect.

Direct Access Number — F811

Parameter Type — **Numerical**

Factory Default — **0**

Changeable During Run — **Yes**

Minimum — **0**

Maximum — **100**

Units — **%**

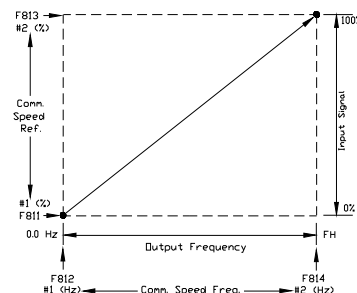

Point 1 Frequency

Program ⇒ Communications ⇒ Communication Reference Adjust

This parameter is used to set the gain and bias of the **Communications Reference** speed control input.

See F811 for more information on this setting.

This parameter sets **Communications Reference Speed Setpoint 1**.

Changes made to this parameter require that the power be cycled (off then on) for the changes to take effect.

Direct Access Number — F812

Parameter Type — **Numerical**

Factory Default — **0.00**

Changeable During Run — **Yes**

Minimum — **0.00**

Maximum — **Max. Freq. (F011)**

Units — **Hz**

Point 2 Setting

Program ⇒ Communications ⇒ Communication Reference Adjust

This parameter is used to set the gain and bias of the **Communications Reference** speed control input.

See F811 for more information on this setting.

This parameter sets the **Communications Reference** input value that represents **Communications Reference Speed Setpoint 2** (frequency). This value is entered as 0 to 100% of the **Communications Reference** input value range.

Changes made to this parameter require that the power be cycled (off then on) for the changes to take effect.

Direct Access Number — F813

Parameter Type — **Numerical**

Factory Default — **100**

Changeable During Run — **Yes**

Minimum — **0**

Maximum — **100**

Units — **%**

Point 2 Frequency

Program ⇒ Communications ⇒ Communication Reference Adjust

This parameter is used to set the gain and bias of the **Communications Reference** speed control input.

See [F811](#) for more information on this setting.

This parameter sets the **Communications Reference Speed Setpoint 2**.

Changes made to this parameter require that the power be cycled (off then on) for the changes to take effect.

Direct Access Number — F814Parameter Type — **Numerical**Factory Default — **60.00**Changeable During Run — **Yes**

Minimum — 0.00

Maximum — **Max. Freq. (F011)**

Units — Hz

Baud Rate (RS485)

Program ⇒ Communications ⇒ Communication Settings

This parameter sets the RSRS485 baud rate.

Changes made to this parameter require that the power be cycled (off then on) for the changes to take effect.

Settings:

0 — 9600 bps

1 — 19200 bps

2 — 38400 bps

Direct Access Number — F820Parameter Type — **Selection List**Factory Default — **19200**Changeable During Run — **Yes**

RS485 Send Wait Time (RS485)

Program ⇒ Communications ⇒ Communication Settings

This parameter sets the **RS485** response delay time.

Changes made to this parameter require that the power be cycled (off then on) for the changes to take effect.

Direct Access Number — F825Parameter Type — **Numerical**

Factory Default — 0.00

Changeable During Run — **Yes**

Minimum — 0.00

Maximum — 2.00

Units — Seconds

ASD-to-ASD Communications (RS485)

Program ⇒ Communications ⇒ Communication Settings

The function of this parameter is 2-fold:

- 1) In a Master/Follower configuration and while communicating via RS485 4-wire, this parameter sets the ASD as the Master or the Follower.
- 2) This parameter determines the function of the ASD while operating as the Master or the Follower. If operating as the Master ASD, an output parameter of the Master ASD is used to control the Follower ASDs and is set here. If operating as a Follower ASD, the ASD response if an error is incurred is set here.

Note: *Select a Follower function here if F806 is configured as a **Master Output** controller for any other ASD in the system. Otherwise, an **EOI** failure will result.*

Changes made to this parameter require that the power be cycled (off then on) for the changes to take effect.

Settings:

- 0 — Follower (Decel Stop if Error Detected)
- 1 — Follower (Continues Operation if Error Detected)
- 2 — Follower (Emergency Off if Error Detected)
- 3 — Master (Frequency Command)
- 4 — Master (Output Frequency)
- 5 — Master (Torque Reference)
- 6 — Master (Output Torque)

Direct Access Number — F826

Parameter Type — Selection List

Factory Default — Follower (Decel Stop)

Changeable During Run — Yes

RS485 Protocol Selection (TSB/ModBus)

Program ⇒ Communications ⇒ Communication Settings

This parameter sets the communications protocol for ASD-to-ASD communications.

Settings:

- 0 — Toshiba
- 1 — Modbus

Direct Access Number — F829

Parameter Type — Selection List

Factory Default — Toshiba

Changeable During Run — Yes

Communications Option (DeviceNet/Profibus) Setting 1

Program ⇒ Communications ⇒ Communication Settings

While using the DeviceNet/Profibus communications protocol, this parameter allows the user to select the read and write information communicated between the ASD and the Host.

Read information may include the ASD fault status, ASD speed, ASD MAC ID, etc. Write information may include Enable/Disable DeviceNet commands, Forward run, ACC/DEC command, etc.

See the **DeviceNet Option Instruction Manual** (P/N 58683) for more information on this parameter.

Settings:

- 0 – 7

Direct Access Number — F830

Parameter Type — Selection List

Factory Default — 0

Changeable During Run — Yes

<p>Communications Option (DeviceNet/Profibus) Setting 2</p> <p>Program ⇒ Communications ⇒ Communication Settings</p> <p>While using the DeviceNet/Profibus communications protocol, parameters F831 – F836 allow the user to select the ASD memory location that holds the Command/Frequency/Monitoring instructions to be applied to the ASD for Communications Option Settings 2 – 7, respectively.</p> <p>See the DeviceNet Option Instruction Manual (P/N 58683) for more information on this parameter.</p> <p>Settings:</p> <ul style="list-style-type: none"> 0 — Disabled 1 — FA06 (ALCAN Command 1) 2 — FA23 (ALCAN Command 2) 3 — FA07 (ALCAN Frequency Command, 0.01 Hz) 4 — FA33 (Torque Command, 0.01%) 5 — FA50 (Terminal Output) 6 — FA51 (Analog Output Data from Comm. [FM]) 7 — FA52 (Analog Output Data from Comm. [AM]) 8 — F601 (Stall Prevention Level, %) 9 — F441 (Power Running Torque Limit 1 Level, 0.01%) 10 — F443 (Regen. Braking Torque Limit 1 Level, 0.01%) 11 — F460 (Speed Loop Proportional Gain) 12 — F461 (Speed Loop Stabilization Coefficient) 	<p>Direct Access Number — F831</p> <p>Parameter Type — Selection List</p> <p>Factory Default — 0000h</p> <p>Changeable During Run — Yes</p>
<p>Communications Option (DeviceNet/Profibus) Setting 3</p> <p>Program ⇒ Communications ⇒ Communication Settings</p> <p>Same as F831. See F831 for information on this parameter</p>	<p>Direct Access Number — F832</p> <p>Parameter Type — Selection List</p> <p>Factory Default — 0000h</p> <p>Changeable During Run — Yes</p>
<p>Communications Option (DeviceNet/Profibus) Setting 4</p> <p>Program ⇒ Communications ⇒ Communication Settings</p> <p>Same as F831. See F831 for information on this parameter</p>	<p>Direct Access Number — F833</p> <p>Parameter Type — Selection List</p> <p>Factory Default — 0000h</p> <p>Changeable During Run — Yes</p>
<p>Communications Option (DeviceNet/Profibus) Setting 5</p> <p>Program ⇒ Communications ⇒ Communication Settings</p> <p>Same as F831. See F831 for information on this parameter</p>	<p>Direct Access Number — F834</p> <p>Parameter Type — Selection List</p> <p>Factory Default — 0000h</p> <p>Changeable During Run — Yes</p>
<p>Communications Option (DeviceNet/Profibus) Setting 6</p> <p>Program ⇒ Communications ⇒ Communication Settings</p> <p>Same as F831. See F831 for information on this parameter</p>	<p>Direct Access Number — F835</p> <p>Parameter Type — Selection List</p> <p>Factory Default — 0000h</p> <p>Changeable During Run — Yes</p>
<p>Communications Option (DeviceNet/Profibus) Setting 7</p> <p>Program ⇒ Communications ⇒ Communication Settings</p> <p>Same as F831. See F831 for information on this parameter</p>	<p>Direct Access Number — F836</p> <p>Parameter Type — Selection List</p> <p>Factory Default — 0000h</p> <p>Changeable During Run — Yes</p>

Communications Option (DeviceNet/Profibus) Setting 8

Program ⇒ Communications ⇒ Communication Settings

While using the DeviceNet/Profibus communications protocol, parameters [F841](#) – [F846](#) allow the user to select the ASD memory location that holds the Command/Frequency/Monitoring instructions to be applied to the ASD for **Communications Option Settings 8 – 13**, respectively.

See the **DeviceNet Option Instruction Manual** (P/N 58683) for more information on this parameter.

Settings:

- 0 — Disabled
- 1 — FD01 (ASD Status 1)
- 2 — FD00 (Output Frequency, 0.01 Hz)
- 3 — FD03 (Output Current, 0.01%)
- 4 — FD05 (Output Voltage, 0.01%)
- 5 — FC91 (ASD Alarm)
- 6 — FD22 (PID Feedback Value, 0.01 Hz)
- 7 — FD06 (Input Terminal Status)
- 8 — FD07 (Output Terminal Status)
- 9 — FE36 (V/I)
- 10 — FE35 (RR Input)
- 11 — FE37 (RX Input)
- 12 — FD04 (Input Voltage [DC Detection], 0.01%)
- 13 — FD16 (Real-time Speed Feedback
- 14 — FD18 (Torque, 0.01%)
- 15 — FE60 (My Monitor)
- 16 — FE61 (My Monitor)
- 17 — FE62 (My Monitor)
- 18 — FE63 (My Monitor)
- 19 — F880 (Free Notes)
- 20 — FD29 (Input Power, 0.01 kW)
- 21 — FD30 (Output Power, 0.01 kW)
- 22 — FE14 (Cumulative Operation Time, 0.01=1 Hour)
- 23 — FE40 (FM Terminal Output Monitor)
- 24 — FE41 (AM Terminal Output Monitor)

Direct Access Number — F841

Parameter Type — Selection List

Factory Default — 0000h

Changeable During Run — Yes

Communications Option (DeviceNet/Profibus) Setting 9

Program ⇒ Communications ⇒ Communication Settings

Same as [F841](#). See [F841](#) for information on this parameter.

Direct Access Number — F842

Parameter Type — Selection List

Factory Default — 0000h

Changeable During Run — Yes

Communications Option (DeviceNet/Profibus) Setting 10

Program ⇒ Communications ⇒ Communication Settings

Same as [F841](#). See [F841](#) for information on this parameter.

Direct Access Number — F843

Parameter Type — Selection List

Factory Default — 0000h

Changeable During Run — Yes

Communications Option (DeviceNet/Profibus) Setting 11

Program ⇒ Communications ⇒ Communication Settings

Same as [F841](#). See [F841](#) for information on this parameter.

Direct Access Number — F844

Parameter Type — Selection List

Factory Default — 0000h

Changeable During Run — Yes

<p>Communications Option (DeviceNet/Profibus) Setting 12</p> <p>Program ⇒ Communications ⇒ Communication Settings</p> <p>Same as F841. See F841 for information on this parameter.</p>	<p>Direct Access Number — F845</p> <p>Parameter Type — Selection List</p> <p>Factory Default — 0000h</p> <p>Changeable During Run — Yes</p>
<p>Communications Option (DeviceNet/Profibus) Setting 13</p> <p>Program ⇒ Communications ⇒ Communication Settings</p> <p>Same as F841. See F841 for information on this parameter.</p>	<p>Direct Access Number — F846</p> <p>Parameter Type — Selection List</p> <p>Factory Default — 0000h</p> <p>Changeable During Run — Yes</p>
<p>Disconnection Detection Extended Time</p> <p>Program ⇒ Communications ⇒ Communication Settings</p> <p>This parameter is used to set the length of time that no communications activity may exist before the communications link is disconnected.</p>	<p>Direct Access Number — F850</p> <p>Parameter Type — Numerical</p> <p>Factory Default — 0.0</p> <p>Changeable During Run — Yes</p> <p>Minimum — 0.0</p> <p>Maximum — 100.0</p> <p>Units — Seconds</p>
<p>ASD Operation at Disconnect</p> <p>Program ⇒ Communications ⇒ Communication Settings</p> <p>This parameter is used to set the H9 ASD action to be carried out in the event of the loss of communications.</p> <p>Settings:</p> <ul style="list-style-type: none"> 0 — Stop and Terminate Communication 1 — Do Nothing (Continue Programmed Operation) 2 — Deceleration Stop 3 — Coast Stop 4 — Emergency Off 5 — Preset Speed (Setting of F852) 	<p>Direct Access Number — F851</p> <p>Parameter Type — Selection List</p> <p>Factory Default — Stop and Terminate Communication</p> <p>Changeable During Run — Yes</p>
<p>Preset Speed Operation Selection</p> <p>Program ⇒ Communications ⇒ Communication Settings</p> <p>This parameter setting is used to set the Preset Speed selection to be used if Preset Speed is selected at parameter F851.</p> <p>Settings:</p> <ul style="list-style-type: none"> 0 — Disabled 1 – 15 — Preset Speed Number 	<p>Direct Access Number — F852</p> <p>Parameter Type — Selection List</p> <p>Factory Default — 0 (Disabled)</p> <p>Changeable During Run — Yes</p>
<p>Communications Option Station Address Monitor</p> <p>Program ⇒ Communications ⇒ Communication Settings</p> <p>This parameter is used in the setup of the communications network by reading the Media Access Code (MAC) address of the ASD that is connected to a node of the communications system.</p> <p>The MAC Address is set via DIP switches of the optional device.</p> <p>See the DeviceNet Option Instruction Manual (P/N 58683) for more information on this parameter.</p>	<p>Direct Access Number — F853</p> <p>Parameter Type — Selection List</p> <p>Factory Default — 0 (Disabled)</p> <p>Changeable During Run — Yes</p> <p>Minimum — 0</p> <p>Maximum — 255</p>

**Communications Option Speed Switch Monitor DeviceNet/
CC-Link**

Program ⇒ Communications ⇒ Communication Settings

This parameter is used in the setup of the communications network by reading the hardware-specific settings of the option card being used with the ASD.

If using the **DEV002Z** Devicenet card, this parameter reads the hardware switch SW300 setting of the Devicenet card. SW300 sets the baud rate and the MAC address of the option card that is connected to a node of the communications system.

See the **DeviceNet Option Instruction Manual** (P/N 58683) for more information on this parameter or see the Instruction manual for the option being used with the H9 ASD.

Direct Access Number — F854
Parameter Type — **Hardware Selectable**
Factory Default — **Option-Specific**
Changeable During Run — **No**
Minimum — 0
Maximum — 255

Block Write Data 1

Program ⇒ Communications ⇒ Communication Settings

This parameter plays a role in the setup of the communications network by establishing the type of data to be written to the ASD of the communications link.

The communications network includes other ASDs and Host/Control computers that monitor the status of the ASD(s), transfers commands, and loads or modifies the parameter settings of the ASD.

Changes made to this parameter require that the power be cycled (off then on) for the changes to take effect.

Settings:

- 0 — None
- 1 — FA00 (Command 1)
- 2 — FA20 (Command 2)
- 3 — FA01 (Frequency)
- 4 — FA50 (TB Output)
- 5 — FA51 (Analog Output)

Direct Access Number — F870
Parameter Type — **Selection List**
Factory Default — **None**
Changeable During Run — **Yes**

Block Write Data 2

Program ⇒ Communications ⇒ Communication Settings

This parameter plays a role in the setup of the communications network by establishing the type of data to be written to the ASD of the communications link.

The communications network includes other ASDs and Host/Control computers that monitor the status of the ASD(s), transfers commands, and loads or modifies the parameter settings of the ASD.

Changes made to this parameter require that the power be cycled (off then on) for the changes to take effect.

Settings:

- 0 — None
- 1 — FA00 (Command 1)
- 2 — FA20 (Command 2)
- 3 — FA01 (Frequency)
- 4 — FA50 (TB Output)
- 5 — FA51 (Analog Output)

Direct Access Number — F871
Parameter Type — **Selection List**
Factory Default — **None**
Changeable During Run — **Yes**

Block Read Data 1

Program ⇒ Communications ⇒ Communication Settings

This parameter plays a role in the setup of the communications network by establishing the type of data to be read from the ASD using the communications link.

The communications network includes other ASDs and Host/Control computers that monitor the status of the ASD(s), transfers commands, and loads or modifies the parameter settings of the ASD.

Changes made to this parameter require that the power be cycled (off then on) for the changes to take effect.

Settings:

- 0 — None
- 1 — Status Information
- 2 — Output Frequency
- 3 — Output Current
- 4 — Output Voltage
- 5 — Alarm Information
- 6 — PID Feedback Value
- 7 — Input Terminal Status
- 8 — Output Terminal Status
- 9 — V/I
- 10 — RR
- 11 — RX
- 12 — DC Voltage
- 13 — PG Feedback
- 14 — Torque
- 15 — My Monitor 1
- 16 — My Monitor 2
- 17 — My Monitor 3
- 18 — My Monitor 4
- 19 — Free Memo

Direct Access Number — F875

Parameter Type — **Selection List**

Factory Default — 0 (None)

Changeable During Run — **Yes**

Block Read Data 2

Program ⇒ Communications ⇒ Communication Settings

This parameter plays a role in the setup of the communications network by establishing the type of data to be read from the ASD of the communications link.

See parameter [F875](#) for more information on this setting.

Direct Access Number — F876

Parameter Type — **Selection List**

Factory Default — None

Changeable During Run — **Yes**

Block Read Data 3

Program ⇒ Communications ⇒ Communication Settings

This parameter plays a role in the setup of the communications network by establishing the type of data to be read from the ASD of the communications link.

See parameter [F875](#) for more information on this setting.

Direct Access Number — F877

Parameter Type — **Selection List**

Factory Default — None

Changeable During Run — **Yes**

<p>Block Read Data 4</p> <p>Program ⇒ Communications ⇒ Communication Settings</p> <p>This parameter plays a role in the setup of the communications network by establishing the type of data to be read from the ASD of the communications link.</p> <p>See parameter F875 for more information on this setting.</p>	<p>Direct Access Number — F878</p> <p>Parameter Type — Selection List</p> <p>Factory Default — None</p> <p>Changeable During Run — Yes</p>
<p>Block Read Data 5</p> <p>Program ⇒ Communications ⇒ Communication Settings</p> <p>This parameter plays a role in the setup of the communications network by establishing the type of data to be read from the ASD of the communications link.</p> <p>See parameter F875 for more information on this setting.</p>	<p>Direct Access Number — F879</p> <p>Parameter Type — Selection List</p> <p>Factory Default — None</p> <p>Changeable During Run — Yes</p>
<p>Free Notes</p> <p>Program ⇒ Communications ⇒ Communication Settings</p> <p>This is an unused parameter that has allocated memory space.</p> <p>The space may be used at the discretion of the user. This space may be used to store information or a note to be transferred using communications.</p>	<p>Direct Access Number — F880</p> <p>Parameter Type — Numerical</p> <p>Factory Default — 0</p> <p>Changeable During Run — Yes</p> <p>Minimum — 0</p> <p>Maximum — 65534</p>
<p>Network Option Reset Settings</p> <p>Program ⇒ Communications ⇒ Communication Settings</p> <p>This parameter plays a role in the setup of the communications network by establishing the targets of a Reset command received via the communications link.</p> <p>Settings:</p> <ul style="list-style-type: none"> 0 — Reset ASD only 1 — Reset Option Board and ASD 	<p>Direct Access Number — F899</p> <p>Parameter Type — Selection List</p> <p>Factory Default — Reset ASD only</p> <p>Changeable During Run — Yes</p>
<p>Input Function Target 1</p> <p>Program ⇒ My Function ⇒ My Function Unit 1</p> <p>This parameter plays a role in the setup of the My Function feature by selecting the functionality of the programmable Input Function Target 1 terminal.</p> <p>This setting assigns the function of the programmable Input Function Target 1 terminal to any one of the user-selectable functions listed in Table 7 on pg. 238, Table 8 on pg. 239, or Table 10 on pg. 241.</p> <p>See F977 for more information on this parameter.</p>	<p>Direct Access Number — F900</p> <p>Parameter Type — Selection List</p> <p>Factory Default — 0 (Disabled)</p> <p>Changeable During Run — Yes</p>
<p>Input Function Command 1</p> <p>Program ⇒ My Function ⇒ My Function Unit 1</p> <p>This parameter is used to assign a user-selected logical operator to two user-selected Input Function Target variables, enable a counter/timer function, or perform a hold/reset function.</p> <p>Table 11 on pg. 243 lists the available selections. Their use and selection requirements are described in an example at F977.</p>	<p>Direct Access Number — F901</p> <p>Parameter Type — Selection List</p> <p>Factory Default — 0 (NOP)</p>

<p>Input Function Target 2</p> <p>Program ⇒ My Function ⇒ My Function Unit 1</p> <p>This parameter plays a role in the setup of the My Function feature by selecting the functionality of the programmable Input Function Target 2 terminal.</p> <p>This setting assigns the function of the programmable Input Function Target 2 terminal to any one of the user-selectable functions listed in Table 7 on pg. 238, Table 8 on pg. 239, or Table 10 on pg. 241.</p> <p>See F977 for more information on this parameter.</p>	<p>Direct Access Number — F902</p> <p>Parameter Type — Selection List</p> <p>Factory Default — 0 (Disabled)</p> <p>Changeable During Run — Yes</p>
<p>Input Function Command 2</p> <p>Program ⇒ My Function ⇒ My Function Unit 1</p> <p>This parameter is used to assign a user-selected logical operator to two user-selected Input Function Target variables, enable a counter/timer function, or perform a hold/reset function.</p> <p>Table 11 on pg. 243 lists the available selections. Their use and selection requirements are described in an example at F977.</p>	<p>Direct Access Number — F903</p> <p>Parameter Type — Selection List</p> <p>Factory Default — 0 (NOP)</p>
<p>Input Function Target 3</p> <p>Program ⇒ My Function ⇒ My Function Unit 1</p> <p>This parameter plays a role in the setup of the My Function feature by selecting the functionality of the programmable Input Function Target 3 terminal.</p> <p>This setting assigns the function of the programmable Input Function Target 3 terminal to any one of the user-selectable functions listed in Table 7 on pg. 238, Table 8 on pg. 239, or Table 10 on pg. 241.</p> <p>See F977 for more information on this parameter.</p>	<p>Direct Access Number — F904</p> <p>Parameter Type — Selection List</p> <p>Factory Default — 0 (Disabled)</p> <p>Changeable During Run — Yes</p>
<p>Output Function Assigned</p> <p>Program ⇒ My Function ⇒ My Function Unit 1</p> <p>This parameter plays a role in the setup of the My Function feature by selecting the functionality of the Output Function Assigned terminal.</p> <p>This setting assigns the function of the programmable Output Function Assigned data location to one of the functions listed in the Input Setting field of Table 7 on pg. 238.</p> <p>Settings:</p> <p>0 – 3099</p> <p>See the My Function Instruction Manual (P/N E6581335) and F977 for more information on this parameter.</p>	<p>Direct Access Number — F905</p> <p>Parameter Type — Selection List</p> <p>Factory Default — 0 (Disabled)</p> <p>Changeable During Run — Yes</p>

<p>Input Function Target 1</p> <p>Program ⇒ My Function ⇒ My Function Unit 2</p> <p>This parameter plays a role in the setup of the My Function feature by selecting the functionality of the programmable Input Function Target 1 terminal.</p> <p>This setting assigns the function of the programmable Input Function Target 1 terminal to any one of the user-selectable functions listed in Table 7 on pg. 238, Table 8 on pg. 239, or Table 10 on pg. 241.</p> <p>See F977 for more information on this parameter.</p>	<p>Direct Access Number — F906</p> <p>Parameter Type — Selection List</p> <p>Factory Default — 0 (Disabled)</p> <p>Changeable During Run — Yes</p>
<p>Input Function Command 1</p> <p>Program ⇒ My Function ⇒ My Function Unit 2</p> <p>This parameter is used to assign a user-selected logical operator to two user-selected Input Function Target variables, enable a counter/timer function, or perform a hold/reset function.</p> <p>Table 11 on pg. 243 lists the available selections. Their use and selection requirements are described in an example at F977.</p>	<p>Direct Access Number — F907</p> <p>Parameter Type — Selection List</p> <p>Factory Default — 0 (NOP)</p>
<p>Input Function Target 2</p> <p>Program ⇒ My Function ⇒ My Function Unit 2</p> <p>This parameter plays a role in the setup of the My Function feature by selecting the functionality of the programmable Input Function Target 2 terminal.</p> <p>This setting assigns the function of the programmable Input Function Target 2 terminal to any one of the user-selectable functions listed in Table 7 on pg. 238, Table 8 on pg. 239, or Table 10 on pg. 241.</p> <p>See F977 for more information on this parameter.</p>	<p>Direct Access Number — F908</p> <p>Parameter Type — Selection List</p> <p>Factory Default — 0 (Disabled)</p> <p>Changeable During Run — Yes</p>
<p>Input Function Command 2</p> <p>Program ⇒ My Function ⇒ My Function Unit 2</p> <p>This parameter is used to assign a user-selected logical operator to two user-selected Input Function Target variables, enable a counter/timer function, or perform a hold/reset function.</p> <p>Table 11 on pg. 243 lists the available selections. Their use and selection requirements are described in an example at F977.</p>	<p>Direct Access Number — F909</p> <p>Parameter Type — Selection List</p> <p>Factory Default — 0 (NOP)</p>
<p>Input Function Target 3</p> <p>Program ⇒ My Function ⇒ My Function Unit 2</p> <p>This parameter plays a role in the setup of the My Function feature by selecting the functionality of the programmable Input Function Target 3 terminal.</p> <p>This setting assigns the function of the programmable Input Function Target 3 terminal to any one of the user-selectable functions listed in Table 7 on pg. 238, Table 8 on pg. 239, or Table 10 on pg. 241.</p> <p>See F977 for more information on this parameter.</p>	<p>Direct Access Number — F910</p> <p>Parameter Type — Selection List</p> <p>Factory Default — 0 (Disabled)</p> <p>Changeable During Run — Yes</p>

<p>Output Function Assigned</p> <p>Program ⇒ My Function ⇒ My Function Unit 2</p> <p>This parameter plays a role in the setup of the My Function feature by selecting the functionality of the Output Function Assigned terminal.</p> <p>This setting assigns the function of the programmable Output Function Assigned data location to one of the functions listed in the Input Setting field of Table 8 on pg. 239.</p> <p>Settings:</p> <p>0 – 3099</p> <p>See the My Function Instruction Manual (P/N E6581335) and F977 for more information on this parameter.</p>	<p>Direct Access Number — F911</p> <p>Parameter Type — Selection List</p> <p>Factory Default — 0 (Disabled)</p> <p>Changeable During Run — Yes</p>
<p>Input Function Target 1</p> <p>Program ⇒ My Function ⇒ My Function Unit 3</p> <p>This parameter plays a role in the setup of the My Function feature by selecting the functionality of the programmable Input Function Target 1 terminal.</p> <p>This setting assigns the function of the programmable Input Function Target 1 terminal to any one of the user-selectable functions listed in Table 7 on pg. 238, Table 8 on pg. 239, or Table 10 on pg. 241.</p> <p>See F977 for more information on this parameter.</p>	<p>Direct Access Number — F912</p> <p>Parameter Type — Selection List</p> <p>Factory Default — 0 (Disabled)</p> <p>Changeable During Run — Yes</p>
<p>Input Function Command 1</p> <p>Program ⇒ My Function ⇒ My Function Unit 3</p> <p>This parameter is used to assign a user-selected logical operator to two user-selected Input Function Target variables, enable a counter/timer function, or perform a hold/reset function.</p> <p>Table 11 on pg. 243 lists the available selections. Their use and selection requirements are described in an example at F977.</p>	<p>Direct Access Number — F913</p> <p>Parameter Type — Selection List</p> <p>Factory Default — 0 (NOP)</p>
<p>Input Function Target 2</p> <p>Program ⇒ My Function ⇒ My Function Unit 3</p> <p>This parameter plays a role in the setup of the My Function feature by selecting the functionality of the programmable Input Function Target 2 terminal.</p> <p>This setting assigns the function of the programmable Input Function Target 2 terminal to any one of the user-selectable functions listed in Table 7 on pg. 238, Table 8 on pg. 239, or Table 10 on pg. 241.</p> <p>See F977 for more information on this parameter.</p>	<p>Direct Access Number — F914</p> <p>Parameter Type — Selection List</p> <p>Factory Default — 0 (Disabled)</p> <p>Changeable During Run — Yes</p>
<p>Input Function Command 2</p> <p>Program ⇒ My Function ⇒ My Function Unit 3</p> <p>This parameter is used to assign a user-selected logical operator to two user-selected Input Function Target variables, enable a counter/timer function, or perform a hold/reset function.</p> <p>Table 11 on pg. 243 lists the available selections. Their use and selection requirements are described in an example at F977.</p>	<p>Direct Access Number — F915</p> <p>Parameter Type — Selection List</p> <p>Factory Default — 0 (NOP)</p>

<p>Input Function Target 3</p> <p>Program ⇒ My Function ⇒ My Function Unit 3</p> <p>This parameter plays a role in the setup of the My Function feature by selecting the functionality of the programmable Input Function Target 3 terminal.</p> <p>This setting assigns the function of the programmable Input Function Target 3 terminal to any one of the user-selectable functions listed in Table 7 on pg. 238, Table 8 on pg. 239, or Table 10 on pg. 241.</p> <p>See F977 for more information on this parameter.</p>	<p>Direct Access Number — F916</p> <p>Parameter Type — Selection List</p> <p>Factory Default — 0 (Disabled)</p> <p>Changeable During Run — Yes</p>
<p>Output Function Assigned</p> <p>Program ⇒ My Function ⇒ My Function Unit 3</p> <p>This parameter plays a role in the setup of the My Function feature by selecting the functionality of the Output Function Assigned terminal.</p> <p>This setting assigns the function of the programmable Output Function Assigned data location to one of the functions listed in the Input Setting field of Table 8 on pg. 239.</p> <p>Settings:</p> <p>0 – 3099</p> <p>See the My Function Instruction Manual (P/N E6581335) and F977 for more information on this parameter.</p>	<p>Direct Access Number — F917</p> <p>Parameter Type — Selection List</p> <p>Factory Default — 0 (Disabled)</p> <p>Changeable During Run — Yes</p>
<p>My Function Percent Data 1</p> <p>Program ⇒ My Function ⇒ My Function Data</p> <p>This parameter is used to set the trigger threshold level of the analog signal of the My Function Percent Data 1.</p> <p>The analog signal is selected using the Input Setting number from Table 8 on pg. 239.</p> <p>Once the assigned output value reaches the threshold setting of this parameter the output value is transferred to My Function Out 1.</p> <p>See the My Function Instruction Manual (P/N E6581335) and F977 for more information on this parameter.</p>	<p>Direct Access Number — F918</p> <p>Parameter Type — Numerical</p> <p>Factory Default — 0.00</p> <p>Changeable During Run — Yes</p> <p>Minimum — 0.00</p> <p>Maximum — 200.00</p> <p>Units — %</p>
<p>My Function Percent Data 2</p> <p>Program ⇒ My Function ⇒ My Function Data</p> <p>This parameter is used to set the trigger threshold level of the analog signal of the My Function Percent Data 2.</p> <p>The analog signal is selected using the Input Setting number from Table 8 on pg. 239.</p>	<p>Direct Access Number — F919</p> <p>Parameter Type — Numerical</p> <p>Factory Default — 0.00</p> <p>Changeable During Run — Yes</p> <p>Minimum — 0.00</p> <p>Maximum — 200.00</p> <p>Units — %</p>

My Function Percent Data 3

Program ⇒ My Function ⇒ My Function Data

This parameter is used to set the trigger threshold level of the analog signal of the **My Function Percent Data 3**.

The analog signal is selected using the **Input Setting** number from [Table 8 on pg. 239](#).

Direct Access Number — F920

Parameter Type — **Numerical**

Factory Default — 0.00

Changeable During Run — **Yes**

Minimum — 0.00

Maximum — 200.00

Units — %

My Function Percent Data 4

Program ⇒ My Function ⇒ My Function Data

This parameter is used to set the trigger threshold level of the analog signal of the **My Function Percent Data 4**.

The analog signal is selected using the **Input Setting** number from [Table 8 on pg. 239](#).

Direct Access Number — F921

Parameter Type — **Numerical**

Factory Default — 0.00

Changeable During Run — **Yes**

Minimum — 0.00

Maximum — 200.00

Units — %

My Function Percent Data 5

Program ⇒ My Function ⇒ My Function Data

This parameter is used to set the trigger threshold level of the analog signal of the **My Function Percent Data 5**.

The analog signal is selected using the **Input Setting** number from [Table 8 on pg. 239](#).

Direct Access Number — F922

Parameter Type — **Numerical**

Factory Default — 0.00

Changeable During Run — **Yes**

Minimum — 0.00

Maximum — 200.00

Units — %

My Function Frequency Data 1

Program ⇒ My Function ⇒ My Function Data

This parameter is used to set the trigger threshold level of the analog signal of the **My Function Frequency Data 1**.

The analog signal is selected using the **Input Setting** number from [Table 8 on pg. 239](#).

Direct Access Number — F923

Parameter Type — **Numerical**

Factory Default — 0.00

Changeable During Run — **Yes**

Minimum — 0.00

Maximum — 200.00

Units — %

My Function Frequency Data 2

Program ⇒ My Function ⇒ My Function Data

This parameter is used to set the trigger threshold level of the analog signal of the **My Function Frequency Data 2**.

The analog signal is selected using the **Input Setting** number from [Table 8 on pg. 239](#).

Direct Access Number — F924

Parameter Type — **Numerical**

Factory Default — 0.00

Changeable During Run — **Yes**

Minimum — 0.00

Maximum — 200.00

Units — %

My Function Frequency Data 3

Program ⇒ My Function ⇒ My Function Data

This parameter is used to set the trigger threshold level of the analog signal of the **My Function Frequency Data 1**.

The analog signal is selected using the **Input Setting** number from [Table 8 on pg. 239](#).

Direct Access Number — F925

Parameter Type — **Numerical**

Factory Default — 0.00

Changeable During Run — **Yes**

Minimum — 0.00

Maximum — 200.00

Units — %

<p>My Function Frequency Data 4</p> <p>Program ⇒ My Function ⇒ My Function Data</p> <p>This parameter is used to set the trigger threshold level of the analog signal of the My Function Frequency Data 4.</p> <p>The analog signal is selected using the Input Setting number from Table 8 on pg. 239.</p>	<p>Direct Access Number — F926</p> <p>Parameter Type — Numerical</p> <p>Factory Default — 0.00</p> <p>Changeable During Run — Yes</p> <p>Minimum — 0.00</p> <p>Maximum — 200.00</p> <p>Units — %</p>
<p>My Function Frequency Data 5</p> <p>Program ⇒ My Function ⇒ My Function Data</p> <p>This parameter is used to set the trigger threshold level of the analog signal of the My Function Frequency Data 5.</p> <p>The analog signal is selected using the Input Setting number from Table 8 on pg. 239.</p>	<p>Direct Access Number — F927</p> <p>Parameter Type — Numerical</p> <p>Factory Default — 0.00</p> <p>Changeable During Run — Yes</p> <p>Minimum — 0.00</p> <p>Maximum — 200.00</p> <p>Units — %</p>
<p>My Function Time Data 1</p> <p>Program ⇒ My Function ⇒ My Function Data</p> <p>This parameter is used to set the response delay of the My Function Time Data 1 terminal.</p> <p>The applied discrete input signal must be present at the input terminal of the H9 ASD for the time setting here for a system response.</p> <p>Discrete terminal input activation that does not equal or exceed this setting will be ignored.</p>	<p>Direct Access Number — F928</p> <p>Parameter Type — Numerical</p> <p>Factory Default — 0.01</p> <p>Changeable During Run — Yes</p> <p>Minimum — 0.01</p> <p>Maximum — 600.00</p> <p>Units — Seconds</p>
<p>My Function Time Data 2</p> <p>Program ⇒ My Function ⇒ My Function Data</p> <p>This parameter is used to set the response delay of the My Function Time Data 2 terminal.</p> <p>The applied discrete input signal must be present at the input terminal of the H9 ASD for the time setting here for a system response.</p> <p>Discrete terminal input activation that does not equal or exceed this setting will be ignored.</p>	<p>Direct Access Number — F929</p> <p>Parameter Type — Numerical</p> <p>Factory Default — 0.01</p> <p>Changeable During Run — Yes</p> <p>Minimum — 0.01</p> <p>Maximum — 600.00</p> <p>Units — Seconds</p>
<p>My Function Time Data 3</p> <p>Program ⇒ My Function ⇒ My Function Data</p> <p>This parameter is used to set the response delay of the My Function Time Data 3 terminal.</p> <p>The applied discrete input signal must be present at the input terminal of the H9 ASD for the time setting here for a system response.</p> <p>Discrete terminal input activation that does not equal or exceed this setting will be ignored.</p>	<p>Direct Access Number — F930</p> <p>Parameter Type — Numerical</p> <p>Factory Default — 0.01</p> <p>Changeable During Run — Yes</p> <p>Minimum — 0.01</p> <p>Maximum — 600.00</p> <p>Units — Seconds</p>

<p>My Function Time Data 4</p> <p>Program ⇒ My Function ⇒ My Function Data</p> <p>This parameter is used to set the response delay of the My Function Time Data 4 terminal.</p> <p>The applied discrete input signal must be present at the input terminal of the H9 ASD for the time setting here for a system response.</p> <p>Discrete terminal input activation that does not equal or exceed this setting will be ignored.</p>	<p>Direct Access Number — F931</p> <p>Parameter Type — Numerical</p> <p>Factory Default — 0.01</p> <p>Changeable During Run — Yes</p> <p>Minimum — 0.01</p> <p>Maximum — 600.00</p> <p>Units — Seconds</p>
<p>My Function Time Data 5</p> <p>Program ⇒ My Function ⇒ My Function Data</p> <p>This parameter is used to set the response delay of the My Function Time Data 5 terminal.</p> <p>The applied discrete input signal must be present at the input terminal of the H9 ASD for the time setting here for a system response.</p> <p>Discrete terminal input activation that does not equal or exceed this setting will be ignored.</p>	<p>Direct Access Number — F932</p> <p>Parameter Type — Numerical</p> <p>Factory Default — 0.01</p> <p>Changeable During Run — Yes</p> <p>Minimum — 0.01</p> <p>Maximum — 600.00</p> <p>Units — Seconds</p>
<p>My Function Count Data 1</p> <p>Program ⇒ My Function ⇒ My Function Data</p> <p>This parameter is used to set the pulse-count threshold value used to trigger the discrete output COUNT1 (ON Timer).</p> <p>COUNT1 (ON Timer) outputs a 1 upon reaching the threshold setting of this parameter.</p>	<p>Direct Access Number — F933</p> <p>Parameter Type — Numerical</p> <p>Factory Default — 0</p> <p>Changeable During Run — Yes</p> <p>Minimum — 0</p> <p>Maximum — 9999</p> <p>Units — Pulses</p>
<p>My Function Count Data 2</p> <p>Program ⇒ My Function ⇒ My Function Data</p> <p>This parameter is used to set the pulse-count threshold value used to trigger the discrete output COUNT2 (ON Timer).</p> <p>COUNT2 (ON Timer) outputs a 1 upon reaching the threshold setting at this parameter.</p>	<p>Direct Access Number — F934</p> <p>Parameter Type — Numerical</p> <p>Factory Default — 0</p> <p>Changeable During Run — Yes</p> <p>Minimum — 0</p> <p>Maximum — 9999</p> <p>Units — Pulses</p>
<p>Input Function Target 1</p> <p>Program ⇒ My Function ⇒ My Function Unit 4</p> <p>This parameter plays a role in the setup of the My Function feature by selecting the functionality of the programmable Input Function Target 1 terminal.</p> <p>This setting assigns the function of the programmable Input Function Target 1 terminal to any one of the user-selectable functions listed in Table 7 on pg. 238, Table 8 on pg. 239, or Table 10 on pg. 241.</p> <p>See F977 for more information on this parameter.</p>	<p>Direct Access Number — F935</p> <p>Parameter Type — Selection List</p> <p>Factory Default — 0 (Disabled)</p> <p>Changeable During Run — Yes</p>

Input Function Command 1

Program ⇒ My Function ⇒ My Function Unit 4

This parameter is used to assign a user-selected logical operator to two user-selected **Input Function Target** variables, enable a counter/timer function, or perform a hold/reset function.

[Table 11 on pg. 243](#) lists the available selections. Their use and selection requirements are described in an example at [F977](#).

Direct Access Number — F936Parameter Type — **Selection List**

Factory Default — 0 (NOP)

Input Function Target 2

Program ⇒ My Function ⇒ My Function Unit 4

This parameter plays a role in the setup of the **My Function** feature by selecting the functionality of the programmable **Input Function Target 2** terminal.

This setting assigns the function of the programmable **Input Function Target 2** terminal to any one of the user-selectable functions listed in [Table 7 on pg. 238](#), [Table 8 on pg. 239](#), or [Table 10 on pg. 241](#).

See [F977](#) for more information on this parameter.

Direct Access Number — F937Parameter Type — **Selection List**Factory Default — **0 (Disabled)**Changeable During Run — **Yes****Input Function Command 2**

Program ⇒ My Function ⇒ My Function Unit 4

This parameter is used to assign a user-selected logical operator to two user-selected **Input Function Target** variables, enable a counter/timer function, or perform a hold/reset function.

[Table 11 on pg. 243](#) lists the available selections. Their use and selection requirements are described in an example at [F977](#).

Direct Access Number — F938Parameter Type — **Selection List**

Factory Default — 0 (NOP)

Input Function Target 3

Program ⇒ My Function ⇒ My Function Unit 4

This parameter plays a role in the setup of the **My Function** feature by selecting the functionality of the programmable **Input Function Target 3** terminal.

This setting assigns the function of the programmable **Input Function Target 3** terminal to any one of the user-selectable functions listed in [Table 7 on pg. 238](#), [Table 8 on pg. 239](#), or [Table 10 on pg. 241](#).

See [F977](#) for more information on this parameter.

Direct Access Number — F939Parameter Type — **Selection List**Factory Default — **0 (Disabled)**Changeable During Run — **Yes****Output Function Assigned**

Program ⇒ My Function ⇒ My Function Unit 4

This parameter plays a role in the setup of the **My Function** feature by selecting the functionality of the **Output Function Assigned** terminal.

This setting assigns the function of the programmable **Output Function Assigned** data location to one of the functions listed in the **Input Setting** field of [Table 8 on pg. 239](#).

Settings:

0 – 3099

See the **My Function Instruction Manual** (P/N E6581335) and [F977](#) for more information on this parameter.

Direct Access Number — F940Parameter Type — **Selection List**Factory Default — **0 (Disabled)**Changeable During Run — **Yes**

<p>Input Function Target 1</p> <p>Program ⇒ My Function ⇒ My Function Unit 5</p> <p>This parameter plays a role in the setup of the My Function feature by selecting the functionality of the programmable Input Function Target 1 terminal.</p> <p>This setting assigns the function of the programmable Input Function Target 1 terminal to any one of the user-selectable functions listed in Table 7 on pg. 238, Table 8 on pg. 239, or Table 10 on pg. 241.</p> <p>See F977 for more information on this parameter.</p>	<p>Direct Access Number — F941</p> <p>Parameter Type — Selection List</p> <p>Factory Default — 0 (Disabled)</p> <p>Changeable During Run — Yes</p>
<p>Input Function Command 1</p> <p>Program ⇒ My Function ⇒ My Function Unit 5</p> <p>This parameter is used to assign a user-selected logical operator to two user-selected Input Function Target variables, enable a counter/timer function, or perform a hold/reset function.</p> <p>Table 11 on pg. 243 lists the available selections. Their use and selection requirements are described in an example at F977.</p>	<p>Direct Access Number — F942</p> <p>Parameter Type — Selection List</p> <p>Factory Default — 0 (NOP)</p>
<p>Input Function Target 2</p> <p>Program ⇒ My Function ⇒ My Function Unit 5</p> <p>This parameter plays a role in the setup of the My Function feature by selecting the functionality of the programmable Input Function Target 2 terminal.</p> <p>This setting assigns the function of the programmable Input Function Target 2 terminal to any one of the user-selectable functions listed in Table 7 on pg. 238, Table 8 on pg. 239, or Table 10 on pg. 241.</p> <p>See F977 for more information on this parameter.</p>	<p>Direct Access Number — F943</p> <p>Parameter Type — Selection List</p> <p>Factory Default — 0 (Disabled)</p> <p>Changeable During Run — Yes</p>
<p>Input Function Command 2</p> <p>Program ⇒ My Function ⇒ My Function Unit 5</p> <p>This parameter is used to assign a user-selected logical operator to two user-selected Input Function Target variables, enable a counter/timer function, or perform a hold/reset function.</p> <p>Table 11 on pg. 243 lists the available selections. Their use and selection requirements are described in an example at F977.</p>	<p>Direct Access Number — F944</p> <p>Parameter Type — Selection List</p> <p>Factory Default — 0 (NOP)</p>
<p>Input Function Target 3</p> <p>Program ⇒ My Function ⇒ My Function Unit 5</p> <p>This parameter plays a role in the setup of the My Function feature by selecting the functionality of the programmable Input Function Target 3 terminal.</p> <p>This setting assigns the function of the programmable Input Function Target 3 terminal to any one of the user-selectable functions listed in Table 7 on pg. 238, Table 8 on pg. 239, or Table 10 on pg. 241.</p> <p>See F977 for more information on this parameter.</p>	<p>Direct Access Number — F945</p> <p>Parameter Type — Selection List</p> <p>Factory Default — 0 (Disabled)</p> <p>Changeable During Run — Yes</p>

Output Function Assigned

Program ⇒ My Function ⇒ My Function Unit 5

This parameter plays a role in the setup of the **My Function** feature by selecting the functionality of the **Output Function Assigned** terminal.

This setting assigns the function of the programmable **Output Function Assigned** data location to one of the functions listed in the **Input Setting** field of [Table 8 on pg. 239](#).

Settings:

0 – 3099

See the **My Function Instruction Manual** (P/N E6581335) and [F977](#) for more information on this parameter.

Direct Access Number — F946Parameter Type — **Selection List**Factory Default — **0 (Disabled)**Changeable During Run — **Yes**

Input Function Target 1

Program ⇒ My Function ⇒ My Function Unit 6

This parameter plays a role in the setup of the **My Function** feature by selecting the functionality of the programmable **Input Function Target 1** terminal.

This setting assigns the function of the programmable **Input Function Target 1** terminal to any one of the user-selectable functions listed in [Table 7 on pg. 238](#), [Table 8 on pg. 239](#), or [Table 10 on pg. 241](#).

See [F977](#) for more information on this parameter.

Direct Access Number — F947Parameter Type — **Selection List**Factory Default — **0 (Disabled)**Changeable During Run — **Yes**

Input Function Command 1

Program ⇒ My Function ⇒ My Function Unit 6

This parameter is used to assign a user-selected logical operator to two user-selected **Input Function Target** variables, enable a counter/timer function, or perform a hold/reset function.

[Table 11 on pg. 243](#) lists the available selections. Their use and selection requirements are described in an example at [F977](#).

Direct Access Number — F948Parameter Type — **Selection List**

Factory Default — 0 (NOP)

Input Function Target 2

Program ⇒ My Function ⇒ My Function Unit 6

This parameter plays a role in the setup of the **My Function** feature by selecting the functionality of the programmable **Input Function Target 2** terminal.

This setting assigns the function of the programmable **Input Function Target 2** terminal to any one of the user-selectable functions listed in [Table 7 on pg. 238](#), [Table 8 on pg. 239](#), or [Table 10 on pg. 241](#).

See [F977](#) for more information on this parameter.

Direct Access Number — F949Parameter Type — **Selection List**Factory Default — **0 (Disabled)**Changeable During Run — **Yes**

Input Function Command 2

Program ⇒ My Function ⇒ My Function Unit 6

This parameter is used to assign a user-selected logical operator to two user-selected **Input Function Target** variables, enable a counter/timer function, or perform a hold/reset function.

[Table 11 on pg. 243](#) lists the available selections. Their use and selection requirements are described in an example at [F977](#).

Direct Access Number — F950Parameter Type — **Selection List**

Factory Default — 0 (NOP)

<p>Input Function Target 3</p> <p>Program ⇒ My Function ⇒ My Function Unit 6</p> <p>This parameter plays a role in the setup of the My Function feature by selecting the functionality of the programmable Input Function Target 3 terminal.</p> <p>This setting assigns the function of the programmable Input Function Target 3 terminal to any one of the user-selectable functions listed in Table 7 on pg. 238, Table 8 on pg. 239, or Table 10 on pg. 241.</p> <p>See F977 for more information on this parameter.</p>	<p>Direct Access Number — F951</p> <p>Parameter Type — Selection List</p> <p>Factory Default — 0 (Disabled)</p> <p>Changeable During Run — Yes</p>
<p>Output Function Assigned</p> <p>Program ⇒ My Function ⇒ My Function Unit 6</p> <p>This parameter plays a role in the setup of the My Function feature by selecting the functionality of the Output Function Assigned terminal.</p> <p>This setting assigns the function of the programmable Output Function Assigned data location to one of the functions listed in the Input Setting field of Table 8 on pg. 239.</p> <p>Settings:</p> <p>0 – 3099</p> <p>See the My Function Instruction Manual (P/N E6581335) and F977 for more information on this parameter.</p>	<p>Direct Access Number — F952</p> <p>Parameter Type — Selection List</p> <p>Factory Default — 0 (Disabled)</p> <p>Changeable During Run — Yes</p>
<p>Input Function Target 1</p> <p>Program ⇒ My Function ⇒ My Function Unit 7</p> <p>This parameter plays a role in the setup of the My Function feature by selecting the functionality of the programmable Input Function Target 1 terminal.</p> <p>This setting assigns the function of the programmable Input Function Target 1 terminal to any one of the user-selectable functions listed in Table 7 on pg. 238, Table 8 on pg. 239, or Table 10 on pg. 241.</p> <p>See F977 for more information on this parameter.</p>	<p>Direct Access Number — F953</p> <p>Parameter Type — Selection List</p> <p>Factory Default — 0 (Disabled)</p> <p>Changeable During Run — Yes</p>
<p>Input Function Command 1</p> <p>Program ⇒ My Function ⇒ My Function Unit 7</p> <p>This parameter is used to assign a user-selected logical operator to two user-selected Input Function Target variables, enable a counter/timer function, or perform a hold/reset function.</p> <p>Table 11 on pg. 243 lists the available selections. Their use and selection requirements are described in an example at F977.</p>	<p>Direct Access Number — F954</p> <p>Parameter Type — Selection List</p> <p>Factory Default — 0 (NOP)</p>

<p>Input Function Target 2</p> <p>Program ⇒ My Function ⇒ My Function Unit 7</p> <p>This parameter plays a role in the setup of the My Function feature by selecting the functionality of the programmable Input Function Target 2 terminal.</p> <p>This setting assigns the function of the programmable Input Function Target 2 terminal to any one of the user-selectable functions listed in Table 7 on pg. 238, Table 8 on pg. 239, or Table 10 on pg. 241.</p> <p>See F977 for more information on this parameter.</p>	<p>Direct Access Number — F955</p> <p>Parameter Type — Selection List</p> <p>Factory Default — 0 (Disabled)</p> <p>Changeable During Run — Yes</p>
<p>Input Function Command 2</p> <p>Program ⇒ My Function ⇒ My Function Unit 7</p> <p>This parameter is used to assign a user-selected logical operator to two user-selected Input Function Target variables, enable a counter/timer function, or perform a hold/reset function.</p> <p>Table 11 on pg. 243 lists the available selections. Their use and selection requirements are described in an example at F977.</p>	<p>Direct Access Number — F956</p> <p>Parameter Type — Selection List</p> <p>Factory Default — 0 (NOP)</p>
<p>Input Function Target 3</p> <p>Program ⇒ My Function ⇒ My Function Unit 7</p> <p>This parameter plays a role in the setup of the My Function feature by selecting the functionality of the programmable Input Function Target 3 terminal.</p> <p>This setting assigns the function of the programmable Input Function Target 3 terminal to any one of the user-selectable functions listed in Table 7 on pg. 238, Table 8 on pg. 239, or Table 10 on pg. 241.</p> <p>See F977 for more information on this parameter.</p>	<p>Direct Access Number — F957</p> <p>Parameter Type — Selection List</p> <p>Factory Default — 0 (Disabled)</p> <p>Changeable During Run — Yes</p>
<p>Output Function Assigned</p> <p>Program ⇒ My Function ⇒ My Function Unit 7</p> <p>This parameter plays a role in the setup of the My Function feature by selecting the functionality of the Output Function Assigned terminal.</p> <p>This setting assigns the function of the programmable Output Function Assigned data location to one of the functions listed in the Input Setting field of Table 8 on pg. 239.</p> <p>Settings:</p> <p>0 – 3099</p> <p>See the My Function Instruction Manual (P/N E6581335) and F977 for more information on this parameter.</p>	<p>Direct Access Number — F958</p> <p>Parameter Type — Selection List</p> <p>Factory Default — 0 (Disabled)</p> <p>Changeable During Run — Yes</p>

Analog Input Function Target 11

Program ⇒ My Function ⇒ My Function Analog

This parameter plays a role in the setup of the **My Function** feature by selecting the functionality of the programmable **Analog Input Function Target 11** terminal.

The function selected at [F961](#) may be adjusted using the input analog control signal selected here.

Settings:

- 0 — Disabled (None)
- 1 — V/I
- 2 — RR
- 3 — RX
- 4 — Optional RX2+, RX2-
- 5 — Optional V/I

Direct Access Number — F959Parameter Type — **Selection List**

Factory Default — 0 (Disabled)

Changeable During Run — **Yes**

Analog Function Assigned Object 11

Program ⇒ My Function ⇒ My Function Analog

This parameter plays a role in the setup of the **My Function** feature by selecting the functionality to which the adjustment of [F959](#) is applied.

Settings:

- 0 — Disabled (None)
- 1 — Acceleration Rate
- 2 — Upper-Limit Frequency
- 3 — Acceleration Multiplication Factor
- 4 — Deceleration Multiplication Factor
- 5 — Manual Torque Boost
- 6 — Over-Current Stall ([F601](#))
- 7 — Thermal Protection
- 8 — Speed Loop Proportional Gain ([F460](#))
- 9 — Drooping Gain ([F320](#))
- 10 — PID Proportional Gain ([F362](#))

See the **My Function Instruction Manual** (P/N E6581335) for a complete description of the setup requirements and operational information of the **Analog Function Assigned Object** parameter.

Direct Access Number — F961Parameter Type — **Selection List**

Factory Default — 0 (Disabled)

Changeable During Run — **Yes**

Analog Input Function Target 21

Program ⇒ My Function ⇒ My Function Analog

This parameter plays a role in the setup of the **My Function** feature by selecting the functionality of the programmable **Analog Input Function Target 21** terminal.

The function selected at [F964](#) may be adjusted using the input analog control signal selected here.

Settings:

- 0 — Disabled (None)
- 1 — V/I
- 2 — RR
- 3 — RX
- 4 — Optional RX2+, RX2-
- 5 — Optional V/I

Direct Access Number — F962Parameter Type — **Selection List**

Factory Default — 0 (Disabled)

Changeable During Run — **Yes**

Analog Function Assigned Object 21

Program ⇒ My Function ⇒ My Function Analog

This parameter plays a role in the setup of the **My Function** feature by selecting the functionality to which the adjustment of [F962](#) is applied.

Settings:

- 0 — Disabled (None)
- 1 — Acceleration Rate
- 2 — Upper-Limit Frequency
- 3 — Acceleration Multiplication Factor
- 4 — Deceleration Multiplication Factor
- 5 — Manual Torque Boost
- 6 — Over-Current Stall ([F601](#))
- 7 — Thermal Protection
- 8 — Speed Loop Proportional Gain ([F460](#))
- 9 — Drooping Gain ([F320](#))
- 10 — PID Proportional Gain ([F362](#))

See the **My Function Instruction Manual** (P/N E6581335) for a complete description of the setup requirements and operational information of the **Analog Function Assigned Object** parameter.

Direct Access Number — F964Parameter Type — **Selection List**

Factory Default — 0 (Disabled)

Changeable During Run — **Yes**

Monitor Output Function 11

Program ⇒ My Function ⇒ My Function Monitor

This parameter plays a role in the setup of the **My Function** feature by establishing the function that is to be recorded and output as the **Peak**, **Minimum**, or **Average** value as selected at parameter [F966](#).

Select the **Monitor Display Input Setting** number from [Table 10 on pg. 241](#) to output the corresponding function.

Use the Communication Number if operating using communications.

See the **My Function Instruction Manual** (P/N E6581335) for a complete description of the setup requirements and operational information of the **Monitor Output Function** parameter.

Direct Access Number — F965Parameter Type — **Selection List**

Factory Default — 2000

Changeable During Run — **Yes**

Monitor Output Function Command 11

Program ⇒ My Function ⇒ My Function Monitor

This parameter plays a role in the setup of the **My Function** feature by allowing the user to select the **Peak**, **Minimum**, or **Normal** (Avg.) value of the parameter [F965](#) selection to be recorded and output as a monitored function.

Settings:

- 0 — Normal
- 1 — Peak
- 2 — Minimum

See the **My Function Instruction Manual** (P/N E6581335) for a complete description of the setup requirements and operational information of the **Monitor Output Function** parameter.

Direct Access Number — F966Parameter Type — **Selection List**

Factory Default — Normal

Changeable During Run — **Yes**

Monitor Output Function 21

Program ⇒ My Function ⇒ My Function Monitor

This parameter plays a role in the setup of the **My Function** feature by establishing the function that is to be recorded and output as the **Peak**, **Minimum**, or **Average** value as selected at parameter [F968](#).

Select the **Monitor Display Input Setting** number from [Table 10 on pg. 241](#) to output the corresponding function.

Use the **Communication Number** if operating using communications.

See the **My Function Instruction Manual** (P/N E6581335) for a complete description of the setup requirements and operational information of the **Monitor Output Function** parameter.

Direct Access Number — F967Parameter Type — **Selection List**

Factory Default — 2000

Changeable During Run — **Yes**

Monitor Output Function Command 21

Program ⇒ My Function ⇒ My Function Monitor

This parameter plays a role in the setup of the **My Function** feature by allowing the user to select the **Peak**, **Minimum**, or **Normal** (Avg.) value of the parameter [F967](#) selection to be recorded and output as a monitored function.

Settings:

0 — Normal

1 — Peak

2 — Minimum

See the **My Function Instruction Manual** (P/N E6581335) for a complete description of the setup requirements and operational information of the **Monitor Output Function** parameter.

Direct Access Number — F968Parameter Type — **Selection List**

Factory Default — Normal

Changeable During Run — **Yes**

Monitor Output Function 31

Program ⇒ My Function ⇒ My Function Monitor

This parameter plays a role in the setup of the **My Function** feature by establishing the function that is to be recorded and output as the **Peak**, **Minimum**, or **Average** value as selected at parameter [F970](#).

Select the **Monitor Display Input Setting** number from [Table 10 on pg. 241](#) to output the corresponding function.

Use the **Communication Number** if operating using communications.

See the **My Function Instruction Manual** (P/N E6581335) for a complete description of the setup requirements and operational information of the **Monitor Output Function** parameter.

Direct Access Number — F969Parameter Type — **Selection List**

Factory Default — 2000

Changeable During Run — **Yes**

Monitor Output Function Command 31

Program ⇒ My Function ⇒ My Function Monitor

This parameter plays a role in the setup of the **My Function** feature by allowing the user to select the **Peak**, **Minimum**, or **Normal** (Avg.) value of the parameter [F969](#) selection to be recorded and output as a monitored function.

See the **My Function Instruction Manual** (P/N E6581335) for a complete description of the setup requirements and operational information of the **Monitor Output Function** parameter.

Settings:

- 0 — Normal
- 1 — Peak
- 2 — Minimum

Direct Access Number — F970Parameter Type — **Selection List**

Factory Default — Normal

Changeable During Run — **Yes**

Monitor Output Function 41

Program ⇒ My Function ⇒ My Function Monitor

This parameter plays a role in the setup of the **My Function** feature by establishing the function that is to be recorded and output as the **Peak**, **Minimum**, or **Normal** (Avg.) value as selected at parameter [F972](#).

Select the **Monitor Display Input Setting** number from [Table 10 on pg. 241](#) to output the corresponding function.

Use the Communication Number if operating using communications.

See the **My Function Instruction Manual** (P/N E6581335) for a complete description of the setup requirements and operational information of the **Monitor Output Function** parameter.

Direct Access Number — F971Parameter Type — **Selection List**

Factory Default — 2000

Changeable During Run — **Yes**

Monitor Output Function Command 41

Program ⇒ My Function ⇒ My Function Monitor

This parameter plays a role in the setup of the **My Function** feature by allowing the user to select the **Peak**, **Minimum**, or **Normal** (Avg.) value of the parameter [F971](#) selection to be recorded and output as a monitored function.

Settings:

- 0 — Normal
- 1 — Peak
- 2 — Minimum

See the **My Function Instruction Manual** (P/N E6581335) for a complete description of the setup requirements and operational information of the **Monitor Output Function** parameter.

Direct Access Number — F972Parameter Type — **Selection List**

Factory Default — Normal

Changeable During Run — **Yes**

Virtual Input Terminal 1 Selection

Program ⇒ Terminal ⇒ Input Terminals

This parameter is used to set the functionality of the **Virtual Input Terminal 1**. As a virtual terminal, it exists only in memory and is considered to always be in its **True** (connected to CC) state.

It is often practical to assign a function to this terminal that the user desires to be maintained regardless of external conditions or operations.

This parameter sets the programmable **Virtual Input Terminal 1** terminal to one of the functions that are listed in [Table 5 on pg. 234](#).

In addition, the input terminal must be specified as **Normally Open** or **Normally Closed**.

Virtual Input Terminal 2 Selection

Program ⇒ Terminal ⇒ Input Terminals

This parameter is used to set the functionality of the **Virtual Input Terminal 2**. As a virtual terminal, it exists only in memory and is considered to always be in its **True** (connected to CC) state.

It is often practical to assign a function to this terminal that the user desires to be maintained regardless of external conditions or operations.

This parameter sets the programmable **Virtual Input Terminal 2** terminal to one of the functions that are listed in [Table 5 on pg. 234](#).

In addition, the input terminal must be specified as **Normally Open** or **Normally Closed**.

Virtual Input Terminal 3 Selection

Program ⇒ Terminal ⇒ Input Terminals

This parameter is used to set the functionality of the **Virtual Input Terminal 3**. As a virtual terminal, it exists only in memory and is considered to always be in its **True** (connected to CC) state.

It is often practical to assign a function to this terminal that the user desires to be maintained regardless of external conditions or operations.

This parameter sets the programmable **Virtual Input Terminal 3** terminal to one of the functions that are listed in [Table 5 on pg. 234](#).

In addition, the input terminal must be specified as **Normally Open** or **Normally Closed**.

Virtual Input Terminal 4 Selection

Program ⇒ Terminal ⇒ Input Terminals

This parameter is used to set the functionality of the **Virtual Input Terminal 4**. As a virtual terminal, it exists only in memory and is considered to always be in its **True** (connected to CC) state.

It is often practical to assign a function to this terminal that the user desires to be maintained regardless of external conditions or operations.

This parameter sets the programmable **Virtual Input Terminal 4** terminal to one of the functions that are listed in [Table 5 on pg. 234](#).

In addition, the input terminal must be specified as **Normally Open** or **Normally Closed**.

Direct Access Number — F973Parameter Type — **Selection List**Factory Default — **Unassigned**Changeable During Run — **No**

Direct Access Number — F974Parameter Type — **Selection List**Factory Default — **Unassigned**Changeable During Run — **No**

Direct Access Number — F975Parameter Type — **Selection List**Factory Default — **Unassigned**Changeable During Run — **No**

Direct Access Number — F976Parameter Type — **Selection List**Factory Default — **Unassigned**Changeable During Run — **No**

My Function Selection

Program ⇒ My Function

This parameter **Enables/Disables** the configured **My Function** feature of the H9 ASD.

Settings:

- 0 — None (Disabled)
- 1 — My Function with Terminal Board Signal (discrete terminal activation)
- 2 — My Function Always On

My Function

The **My Function** feature is configured using the settings of [F900](#) to [F977](#) and is used to enhance the programmability of the H9 ASD by performing two programmable functions: 1) the Combined Terminal Function, and 2) Logic Operations.

Combined Terminal Function

Assigning more than one function to a discrete output terminal provides two advantages: it effectively expands the number of input terminals, and reduces the number of cables required to support the input/output functions (e.g., assigning ST and F to one terminal). Using **Virtual Terminals 1 – 4** ([F973](#) – [F976](#)) are required to use this function.

In the example below, the **ST** terminal assignment and the **F** terminal assignment will be combined as one terminal to illustrate this feature. However, any two of the discrete output terminal assignments listed in [Table 8 on pg. 239](#) may be combined in this manner.

Setup (Example)

1. Disable the **My Function** parameter at [F977](#) to prevent the system from starting upon completion of the setup.
2. Assign the **ST** function to the **S1** terminal ([F115](#)).
3. Assign the **F** function to **Virtual Input Terminal 1** ([F973](#)).
4. Set **Input Function Target 1 to 5** ([F900](#)). This setting assigns **S1** as the control input terminal.
5. Set **Output Function Assigned to 21** ([F905](#)). This setting is a command that writes the **F115** selection (S1) to **Virtual Input Terminal 1**, activating both.
6. Enable the **My Function** parameter at [F977](#) by selecting **My Function Always On** or selecting **My Function With TB Signal**.

If set to **My Function Always On**, the combination of **ST** and **F** are always On (both are connected to CC only during the S1 activation).

If set to **My Function With TB Signal**, set a discrete input terminal to **My Function Run Signal** and connect it to **CC** to enable **My Function**. Connect **S1** to **CC** to activate the **ST+F** function. A disconnection at either terminal will terminate the **My Function** programming (discrete input terminal **My Function Run Signal** is Anded with discrete input terminal **S1**).

Connect **S1** to **CC** and the **F-to-CC** + the **ST-to-CC** functions will be carried out using only **S1**.

With the aforementioned setup completed, provide a **Frequency Command** ([F004](#)) and the motor will run at the commanded frequency.

Continued next page.

Direct Access Number — [F977](#)

Parameter Type — **Selection List**

Factory Default — **None** (Disabled)

Changeable During Run — **No**



This parameter must always be set to **None** at the start of the **My Function** setup and remain set to **None** until all of the **My Function** parameter settings have been confirmed as being correct.

If enabled for normal operation using settings **1** or **2**, the motor may start and engage the driven equipment unexpectedly upon receiving a **Run** signal during the **My Function** setup.

Combined Terminal Function (Cont.)

Output terminals may also be combined to produce one output response to multiple conditions using the computational operators of [Table 11 on pg. 243](#). Assigning more than one function to a discrete output terminal provides two advantages: it effectively expands the number of input terminals, and reduces the number of cables required to support the input/output functions (e.g., assigning Low-Speed Detection and Low Current Detection to one output terminal). Using **Virtual Terminals 1 – 4** ([F973 – F976](#)) are required to use this function.

In the example below, the **Low-Speed Signal** (detection) terminal assignment and the **Low Current Detection** terminal assignment will be combined as one terminal output to illustrate this feature. However, any two of the discrete output terminal assignments may listed in [Table 8 on pg. 239](#) may be combined in this manner.

Setup (example)

1. Disable the **My Function** parameter at [F977](#) to prevent the system from starting upon completion of the setup.
2. From Program ⇒ Direct Access ⇒ Unknown Numbers, select **Enabled**.
3. Set the **OUT1** terminal ([F130](#)) to **My Function Output 1** (222).
4. Set **Input Function Target 1** ([F900](#)) to **1004** (Low-Speed Signal detection). See [Table 8 on pg. 239](#) for a complete listing of available settings.
5. Set **Input Function Target 2** ([F902](#)) to **1026** (Low Current Alarm). See [Table 8 on pg. 239](#) for a complete listing of available settings.
6. Set **Input Function Command 1** ([F901](#)) to **AND** (3). This setting assigns an operator to the **Input Function Target 1** and the **Input Function Target 2** settings.
7. Set **Output Function Assigned** ([F905](#)) to **1222**. This setting will transfer the results of the logical AND to **My Function Output 1** (OUT1).
8. Enable the **My Function** parameter at [F977](#) by selecting **My Function Always On**.

With the aforementioned setup completed in the example, once the **Low-Speed Signal** AND the **Low Current Alarm** are active, the **OUT1** terminal is activated for the duration of the **Low-Speed/Low Current** condition.

See the **My Function Instruction Manual** (P/N E6581335) for a complete description of the setup requirements and operational information of the **My Function** parameter.

Direct Access Number — F977

Parameter Type — Selection List

Factory Default — None (Disabled)

Changeable During Run — No



DANGER

This parameter must always be set to **None** at the start of the **My Function** setup and remain set to **None** until all of the **My Function** parameter settings have been confirmed as being correct.

If enabled for normal operation using settings **1** or **2**, the motor may start and engage the driven equipment unexpectedly upon receiving a **Run** signal during the **My Function** setup.

Traverse Selection

Program ⇒ Special ⇒ Traverse

This parameter setting is used in the setup of the **Traverse** control mode of operation and is used in conjunction with the discrete terminal activation of the **Traverse Permission Signal**.

This parameter is used to enable the **Traverse** function. The **Traverse** function is activated via the discrete input terminal (see [Table 5 on pg. 234](#)).

See the **Traverse Control Instruction Manual** (P/N 58693) for more information on this feature.

Settings:

- 0 — Disabled
- 1 — Enabled

Direct Access Number — F980Parameter Type — **Selection List**Factory Default — **Disabled**Changeable During Run — **No**

Traverse Acceleration Time

Program ⇒ Special ⇒ Traverse

This parameter setting is used in the setup of the **Traverse** control mode of operation. This setting establishes the acceleration rate used during the **Traverse** function.

See the **Traverse Control Instruction Manual** (P/N 58693) for more information on this feature.

Direct Access Number — F981Parameter Type — **Numerical**Factory Default — **25.0**Changeable During Run — **No**

Minimum — 0.1

Maximum — 120.0

Units — Seconds

Traverse Deceleration Time

Program ⇒ Special ⇒ Traverse

This parameter setting is used in the setup of the **Traverse** control mode of operation. This setting establishes the deceleration rate used during the **Traverse** function.

See the **Traverse Control Instruction Manual** (P/N 58693) for more information on this feature.

Direct Access Number — F982Parameter Type — **Numerical**Factory Default — **25.0**Changeable During Run — **No**

Minimum — 0.1

Maximum — 120.0

Units — Seconds

Traverse Step

Program ⇒ Special ⇒ Traverse

This parameter setting is used in the setup of the **Traverse** control mode of operation. This setting is used as a multiplier to establish the amount that the frequency is increased or decreased while using the **Traverse** function.

See the **Traverse Control Instruction Manual** (P/N 58693) for more information on this feature.

Direct Access Number — F983Parameter Type — **Numerical**Factory Default — **10.0**Changeable During Run — **No**

Minimum — 0.0

Maximum — 25.0

Units — %

Traverse Jump Step

Program ⇒ Special ⇒ Traverse

This parameter setting is used in the setup of the **Traverse** control mode of operation. This setting is used as a multiplier to establish the amount that the frequency is increased or decreased while using the **Traverse** function when a short burst of rapid speed change is required.

See the **Traverse Control Instruction Manual** (P/N 58693) for more information on this feature.

Direct Access Number — F984Parameter Type — **Numerical**Factory Default — **10.0**Changeable During Run — **No**

Minimum — 0.0

Maximum — 50.0

Units — %

Table 5. Discrete Input Terminal Assignment Selections and Descriptions.

Sel. No.		Terminal Selection Descriptions																					
NO	NC																						
0	1	Unassigned — No operation.																					
2	3	Forward — Provides a Forward run command.																					
4	5	Reverse — Provides a Reverse run command.																					
6	7	Standby — Enables the Forward and Reverse operation commands.																					
8	9	Reset — Resets the device and any active faults.																					
10	11	Preset Speed 1 — Preset Speed 1 is used as the LSB of the 4-bit nibble that is used to select a Preset Speed .																					
12	13	Preset Speed 2 — Preset Speed 2 is used as the second bit of the 4-bit nibble that is used to select a Preset Speed .																					
14	15	Preset Speed 3 — Preset Speed 3 is used as the third bit of the 4-bit nibble that is used to select a Preset Speed .																					
16	17	Preset Speed 4 — Preset Speed 4 is used as the MSB of the 4-bit nibble that is used to select a Preset Speed .																					
18	19	Jog — This terminal activates a Jog for the duration of the activation. The Jog settings may be configured at F260 – F262 .																					
20	21	Emergency Off — Terminates the output signal from the drive and may apply a brake if so configured. The braking method may be selected at F603 .																					
22	23	DC Braking — Upon activation the drive outputs a DC current that is injected into the windings of the motor to quickly brake the motor.																					
24	25	<p>Accel/Decel Switching 1/Accel/Decel Switching 2 — Activating combinations of discrete input terminals Accel/Decel Switching 1 and 2 allow for the selection of Accel/Decel profiles 1 – 4 as shown below. See F504 for more information on this terminal setting.</p> <table border="1" style="margin-left: auto; margin-right: auto;"> <thead> <tr> <th colspan="2">A/D SW Terminal</th> <th rowspan="2">A/D Profile Selection</th> </tr> <tr> <th>#1</th> <th>#2</th> </tr> </thead> <tbody> <tr> <td>0</td> <td>0</td> <td>1</td> </tr> <tr> <td>0</td> <td>1</td> <td>2</td> </tr> <tr> <td>1</td> <td>0</td> <td>3</td> </tr> <tr> <td>1</td> <td>1</td> <td>4</td> </tr> <tr> <td colspan="3">1=Terminal Activated</td> </tr> </tbody> </table> <p>The settings of the A/D selections 1 – 4 are performed at F009/F010, F500/F501, F510/F511, and F514/F515, respectively.</p> <p>Accel/Decel profiles are comprised of the Accel/Decel settings, Pattern, and Switching Frequency.</p>		A/D SW Terminal		A/D Profile Selection	#1	#2	0	0	1	0	1	2	1	0	3	1	1	4	1=Terminal Activated		
A/D SW Terminal		A/D Profile Selection																					
#1	#2																						
0	0	1																					
0	1	2																					
1	0	3																					
1	1	4																					
1=Terminal Activated																							
26	27	<table border="1" style="margin-left: auto; margin-right: auto;"> <thead> <tr> <th colspan="2">V/f Switching Terminal</th> <th rowspan="2">V/f Selection</th> </tr> <tr> <th>#1</th> <th>#2</th> </tr> </thead> <tbody> <tr> <td>0</td> <td>0</td> <td>1</td> </tr> <tr> <td>0</td> <td>1</td> <td>2</td> </tr> <tr> <td>1</td> <td>0</td> <td>3</td> </tr> <tr> <td>1</td> <td>1</td> <td>4</td> </tr> <tr> <td colspan="3">1=Terminal Activated</td> </tr> </tbody> </table> <p>The 1 – 4 settings of the V/f Switching selections are performed at parameters F170 – F181.</p>		V/f Switching Terminal		V/f Selection	#1	#2	0	0	1	0	1	2	1	0	3	1	1	4	1=Terminal Activated		
V/f Switching Terminal		V/f Selection																					
#1	#2																						
0	0	1																					
0	1	2																					
1	0	3																					
1	1	4																					
1=Terminal Activated																							
28	29	<p>V/f Switching 1/V/f Switching 2 — Activating combinations of discrete input terminals V/f Switching 1 and 2 allow for the selection of a V/f switching profile as listed below.</p> <table border="1" style="margin-left: auto; margin-right: auto;"> <thead> <tr> <th colspan="2">V/f Switching Terminal</th> <th rowspan="2">V/f Selection</th> </tr> <tr> <th>#1</th> <th>#2</th> </tr> </thead> <tbody> <tr> <td>0</td> <td>0</td> <td>1</td> </tr> <tr> <td>0</td> <td>1</td> <td>2</td> </tr> <tr> <td>1</td> <td>0</td> <td>3</td> </tr> <tr> <td>1</td> <td>1</td> <td>4</td> </tr> <tr> <td colspan="3">1=Terminal Activated</td> </tr> </tbody> </table> <p>The 1 – 4 settings of the V/f Switching selections are performed at parameters F170 – F181.</p>		V/f Switching Terminal		V/f Selection	#1	#2	0	0	1	0	1	2	1	0	3	1	1	4	1=Terminal Activated		
V/f Switching Terminal		V/f Selection																					
#1	#2																						
0	0	1																					
0	1	2																					
1	0	3																					
1	1	4																					
1=Terminal Activated																							
30	31	<table border="1" style="margin-left: auto; margin-right: auto;"> <thead> <tr> <th colspan="2">V/f Switching Terminal</th> <th rowspan="2">V/f Selection</th> </tr> <tr> <th>#1</th> <th>#2</th> </tr> </thead> <tbody> <tr> <td>0</td> <td>0</td> <td>1</td> </tr> <tr> <td>0</td> <td>1</td> <td>2</td> </tr> <tr> <td>1</td> <td>0</td> <td>3</td> </tr> <tr> <td>1</td> <td>1</td> <td>4</td> </tr> <tr> <td colspan="3">1=Terminal Activated</td> </tr> </tbody> </table> <p>The 1 – 4 settings of the V/f Switching selections are performed at parameters F170 – F181.</p>		V/f Switching Terminal		V/f Selection	#1	#2	0	0	1	0	1	2	1	0	3	1	1	4	1=Terminal Activated		
V/f Switching Terminal		V/f Selection																					
#1	#2																						
0	0	1																					
0	1	2																					
1	0	3																					
1	1	4																					
1=Terminal Activated																							

Note: NO/NC = Normally Open/Normally Closed.

Table 5. (Continued) Discrete Input Terminal Assignment Selections and Descriptions.

Sel. No.		Terminal Selection Descriptions																		
NO	NC																			
32	33	<p>Torque Limit Switching 1/Torque Limit Switching 2 — Activating combinations of discrete input terminals Torque Limit Switching 1 and 2 allow for the selection of a torque limit switching profile as listed below.</p> <table border="1" style="margin-left: 20px;"> <thead> <tr> <th colspan="2">Torque Limit Switching Terminal</th> <th rowspan="2">Torque Limit Selection</th> </tr> <tr> <th>#1</th> <th>#2</th> </tr> </thead> <tbody> <tr> <td>0</td> <td>0</td> <td>1</td> </tr> <tr> <td>0</td> <td>1</td> <td>2</td> </tr> <tr> <td>1</td> <td>0</td> <td>3</td> </tr> <tr> <td>1</td> <td>1</td> <td>4</td> </tr> </tbody> </table> <p>The 1 – 4 settings of the torque limit switching selections are performed at parameters F440 – F449.</p>		Torque Limit Switching Terminal		Torque Limit Selection	#1	#2	0	0	1	0	1	2	1	0	3	1	1	4
Torque Limit Switching Terminal		Torque Limit Selection																		
#1	#2																			
0	0	1																		
0	1	2																		
1	0	3																		
1	1	4																		
34	35	<p>Torque Limit Switching Terminal</p> <table border="1" style="margin-left: 20px;"> <tbody> <tr> <td colspan="2">1=Terminal Activated</td> </tr> </tbody> </table>		1=Terminal Activated																
1=Terminal Activated																				
36	37	PID Off — Turns off PID control.																		
38	39	Pattern Operation Group 1 — Initiates the Pattern 1 Pattern Run .																		
40	41	Pattern Operation Group 2 — Initiates the Pattern 2 Pattern Run .																		
42	43	Pattern Operation Continuation — Initiates a continuation of the last Pattern Run from its stopping point.																		
44	45	Pattern Operation Trigger — Initiates the first Preset Speed of a Pattern Run and initiates each subsequent enabled Preset Speed with continued activations.																		
46	47	External Over-Heat — Causes an Over-Heat Trip (OH) .																		
48	49	Local Priority (cancels serial priority) — Overrides any serial control and returns the Command and Frequency control to the settings of F003 and F004 .																		
50	51	Hold (3-Wire Stop) — Decelerates the motor to a stop.																		
52	53	PID Differentiation/Integration Clear — Clears the PID value.																		
54	55	PID Forward/Reverse Switching — Toggles the gradient characteristic of the feedback response of the V/I terminal during PID -controlled operation.																		
56	57	Forced Continuous Operation — Ignore PID control settings for the duration of activation.																		
58	59	Specified Speed Operation — Runs speed as commanded by the Frequency Mode setting.																		
60	61	Dwell Signal — Used in conjunction with the Acceleration/Deceleration Suspend function (F349) — suspends the Accel/Decel function for the duration of the activation.																		
62	63	Power Failure Synchronized Signal — Activates the Synchronized Accel/Decel function of the Regenerative Power Ridethrough feature. See F302 for more information on this terminal setting.																		
64	65	My Function Run — Activates the configured My Function feature. See F977 for more information on this parameter.																		
66	67	Autotuning Signal — Initiates the Autotune function. Set F400 to Autotuning by Input Terminal Signal .																		
68	69	Speed Gain Switching — Toggles the ASD operating mode from and to Speed Control and Torque Control . Speed Control operation references parameter settings F460 and F461 . Torque Control operation references parameter settings F462 and F463 .																		
70	71	Servo Lock — Holds the motor at 0 Hz until a Run command is received.																		
72	73	Simple Positioning — While operating in the Positioning Control mode, activation initiates the Stop command. See F381 for more information on this terminal setting.																		
74	75	kWH Display Clear — Clears the kWH meter display.																		
76	77	Trace Back Trigger — Initiates the data Read/Store function of the Trace Selection parameter. See F740 for more information on this feature.																		
78	79	Light-Load High-Speed Disable — Terminates the Light-Load High-Speed operation.																		
<p>Note: NO/NC = Normally Open/Normally Closed.</p>																				

Table 5. (Continued) Discrete Input Terminal Assignment Selections and Descriptions.

Sel. No.		Terminal Selection Descriptions
NO	NC	
86	87	Binary Write — Writes the status of the discrete input terminals to the control board during binary input speed control.
88	89	UP/DOWN Frequency (up) — Increases the speed of the motor for the duration of activation until reaching the Upper-Limit setting or increases the speed of the motor in steps (see F264 for more information on this feature).
90	91	UP/DOWN Frequency (down) — Decreases the speed of the motor for the duration of activation until reaching the Lower-Limit setting or decreases the speed of the motor in steps (see F264 for more information on this feature).
92	93	UP/DOWN Frequency (clear) — While operating in the Up/Down Frequency speed control mode this terminal initiates a 0 Hz output command. If operating with an activated UP/DOWN Frequency (up or down) terminal, the output goes to the Lower-Limit (F013) setting.
98	99	Forward/Reverse — This setting operates in conjunction with another terminal being set to the Run/Stop function. When configured to Run (Run/Stop to CC) , the make or break of this connection to CC changes the direction of the motor.
100	101	Run/Stop — This terminal enables the motor to run when activated and disables the motor when deactivated.
102	103	Commercial Power/ASD Switching — Initiates the ASD-to-Commercial Power switching function. See parameter F354 for more information on this feature.
104	105	Frequency Reference Priority Switching — Toggles frequency control to and from the settings of F004 and F207 .
106	107	V/I Terminal Priority — Assigns Speed control to the V/I Terminal and overrides the F004 setting.
108	109	Command Terminal Board Priority — Assigns Command control to the Terminal Board and overrides the F003 setting.
110	111	Edit Enable — Allows for the override of the lock out parameter setting (F700) allowing for parameter editing.
112	113	Control Switching — Toggles the system to and from the speed control and the torque control modes.
122	123	Fast Deceleration — Using dynamic braking (if enabled and supported), stops the motor at the fastest rate allowed by the load.
124	125	Preliminary Excitation — Applies an excitation current to the motor (holds shaft stationary) for the duration of the activation.
126	127	Brake Request — Initiates the brake release command. This setting requires that another discrete input terminal be set to Brake Answerback Input to complete the brake release command and to convey the status of the braking system to the user or to a dependent subsystem. Once the braking release function is initiated, the Trouble Internal Timer begins to count down (Trouble Internal Timer value is set at F630). Should the count-down timer expire before the brake releases or before the Brake Answerback Input is returned, fault E-11 will occur. Otherwise, the brake releases the motor and normal motor operations resume. The Braking Release function is primarily used at startup; but, may be used when the brake is applied while the motor is running.
130	131	Brake Answerback Input — This setting is required when the Braking Request function is used. The function of this input terminal is to receive the returned the status of the braking system. The returned status is either Released or Not Released . If Released is returned within the time setting of F630 , normal system function resumes. If Not Released is returned or if the F630 time setting times out before either signal is returned, then fault E-11 occurs. The returned signal may also be used to notify the user or control a dependent subsystem.
134	135	Traverse Permission Signal — Enables/Disables the Traverse function. See parameter F980 for more information on this feature.
<i>Note: NO/NC = Normally Open/Normally Closed.</i>		

Table 6. Output Terminal Assignments for the FP, AM, FM, MON1, and MON2 Output Terminals.

Output Meter Terminal Assignments and Display Item Selections			
Selection/ Comm Number	Terminal Assignment Name	Selection/ Comm Number	Terminal Assignment Name
0	Output Frequency	30	100% Meter Adjust Value
1	Frequency Reference	31	Data from Communications
2	Output Current	32	185% Meter Adjust Value
3	DC Bus Voltage	33	250% Meter Adjust Value
4	Output Voltage	34	Input Watt Hour
5	Compensated Frequency	35	Output Watt Hour
6	Speed Feedback (Realtime)	45	Gain Display
7	Speed Feedback (1 Sec Filter)	46	My Function Monitor 1 Without Sign
8	Torque	47	My Function Monitor 2 Without Sign
9	Torque Command	48	My Function Monitor 3 With Sign
11	Torque Current	49	My Function Monitor 4 With Sign
12	Excitation Current	50	Signed Output Frequency
13	PID Feedback Value	51	Signed Frequency Reference
14	Motor Overload Ratio	52	Signed Compensated Frequency
15	ASD Overload Ratio	53	Signed Speed Feedback (Realtime)
16	DBR Overload Ratio	54	Signed Speed Feedback (1 Sec Filter)
17	DBR Load Ratio	55	Signed Torque
18	Input Power	56	Signed Torque Command
19	Output Power	58	Signed Torque Current
23	Option V/I Input	59	Signed PID Feedback Value
24	RR Input	60	Signed RX Input
25	V/I Input	61	Signed RX2 Option (AI1) Input
26	RX Input	62	Signed 100% Meter Adjust Value
27	RX2 Option (AI1) Input	63	Signed 185% Meter Adjust Value
28	FM Output	64	Signed 250% Meter Adjust Value
29	AM Output		

Table 7. My Function Input Function Target Selections.

Selection/ Communications Number	Terminal Assignment	Selection/ Communications Number	Terminal Assignment
0	Unassigned	17	B12
1	Forward	18	B13
2	Reverse	19	B14
3	Standby	20	B15
4	Reset	21	Virtual Input Terminal 1
5	S1	22	Virtual Input Terminal 2
6	S2	23	Virtual Input Terminal 3
7	S3	24	Virtual Input Terminal 4
8	S4	25	Internal Terminal 1
9	LI1	26	Internal Terminal 2
10	LI2	27	Internal Terminal 3
11	LI3	28	Internal Terminal 4
12	LI4	29	Internal Terminal 5
13	LI5	30	Internal Terminal 6
14	LI6	31	Internal Terminal 7
15	LI7	32	Internal Terminal 8
16	LI8		

Table 8. Output Terminal Assignments, My Function Input Setting Assignments, and Parameter/Input Setting Numbers for the FLA/B/C, O1A/O1B (OUT1), O2A/O2B (OUT2), OUT3 – OUT6, and R1 – R4.

Discrete Output Terminal Assignment Selections					
Input Setting	Param. Setting	Function	Input Setting	Param. Setting	Function
1000	0	Lower-Limit Frequency	1086	86	Error Code Output 4
1002	2	Upper-Limit Frequency	1088	88	Error Code Output 5
1004	4	Low-Speed Signal	1090	90	Error Code Output 6
1006	6	Acceleration/Deceleration Completion	1092	92	Specified Data Output 1
1008	8	Speed Reach Signal	1094	94	Specified Data Output 2
1010	10	Failure FL (All Trips)	1096	96	Specified Data Output 3
1012	12	Failure FL (Except EF, OCL, EPHO, OL2)	1098	98	Specified Data Output 4
1014	14	Over-Current (OC) Alarm	1100	100	Specified Data Output 5
1016	16	ASD Overload (OL1) Alarm	1102	102	Specified Data Output 6
1018	18	Motor Overload (OL2) Alarm	1104	104	Specified Data Output 7
1020	20	Over-Heat Alarm	1106	106	Light Load
1022	22	Over-Voltage Alarm	1108	108	Heavy Load
1024	24	Main Circuit (MOFF) Under-Voltage Alarm	1110	110	Positive Torque Limit
1026	26	Low-Current Alarm	1112	112	Negative Torque Limit
1028	28	Over-Torque Alarm	1114	114	External Rush Suppression Relay Activated
1030	30	DBR Overload Alarm	1118	118	Completion of Stop Positioning
1032	32	Emergency Off Active	1120	120	L-STOP
1034	34	Retry Active	1122	122	Power Failure Synchronized Operation
1036	36	Pattern Operation Switching Output	1124	124	Traverse in Progress
1038	38	PID Deviation Limit	1126	126	Traverse Deceleration Active
1040	40	Run/Stop	1128	128	Part Replacement Alarm
1042	42	Serious Failure (OCA, OCL, EF, Phase Failure, etc.)	1130	130	Over-Torque Alarm
1044	44	Light failure (OL, OC1, 2, 3, OP)	1132	132	Frequency Command ½ Selection
1046	46	Commercial Power/ASD Switching Output 1	1134	134	Failure FL (Except Emergency Off)
1048	48	Commercial power/ASD switching Output 2	1222	222	My Function Output 1
1050	50	Cooling Fan On/Off	1224	224	My Function Output 2
1052	52	Jogging Operation Active (Jog Run Active)	1226	226	My Function Output 3
1054	54	Panel/Terminal Board Operation Switching	1228	228	My Function Output 4
1056	56	Cumulative Run-time Alarm	1230	230	My Function Output 5
1058	58	ProfiBus/DeviceNet/CC-Link Communication Error	1232	232	My Function Output 6
1060	60	Forward/Reverse Switching	1234	234	My Function Output 7
1062	62	Ready for Operation 1	1236	236	My Function Output 8
1064	64	Ready for Operation 2	1238	238	My Function Output 9
1068	68	Brake Release (BR)	1240	240	My Function Output 10
1070	70	Alarm Status Active	1242	242	My Function Output 11
1072	72	Forward Speed Limit (Torque Control)	1244	244	My Function Output 12
1074	74	Reverse Speed Limit (Torque Control)	1246	246	My Function Output 13
1076	76	ASD Healthy Output	1248	248	My Function Output 14
1078	78	RS485 Communication Error	1250	250	My Function Output 15
1080	80	Error Code Output 1	1252	252	My Function Output 16
1082	82	Error Code Output 2	1254	254	Always Off
1084	84	Error Code Output 3			

Note: Only positive logic is available for the listed parameters.

Table 9. Trace Back Data Selections.

Selection Number	Comm. Number	Trace (Monitor) Function	Resolution/Unit
0	FD00	Output Frequency	0.01 Hz
1	FD02	Frequency Reference	0.01 Hz
2	FD03	Output Current	0.01%
3	FD04	DC Bus Voltage	0.01%
4	FD05	Output Voltage	0.01%
5	FD15	Compensated Frequency	0.01 Hz
6	FD16	Speed Feedback (Realtime)	0.01 Hz
7	FD17	Speed Feedback (1 Sec Filter)	0.01 Hz
8	FD18	Torque	0.01%
9	FD19	Torque Command	0.01%
11	FD20	Torque Current	0.01%
12	FD21	Excitation Current	0.01%
13	FD22	PID Feedback Value	0.01 Hz
14	FD23	Motor Overload Ratio	0.01%
15	FD24	ASD Overload Ratio	0.01%
16	FD25	DBR Overload Ratio	1%
17	FD28	DBR Load Ratio	1%
18	FD29	Input Power	0.01 kW
19	FD30	Output Power	0.01 kW
23	FE39	V/I Option (AI2)	1%
24	FE35	RR Input	0.01%
25	FE36	V/I Input	0.01%
26	FE37	RX Input	0.01%
27	FE38	RX2 Option (AI1)	1%
28	FE40	FM Output	0.01%
29	FE41	AM Output	0.01%
30	FE51	Signed 100% Meter Adjust Value	1%
31	FA51	Communication Data	N/A
32	FE50	Signed 185% Meter Adjust Value	1%
33	FE67	Signed 250% Meter Adjust Value	1%
34	FE76	Input Watt-Hour	0.01 kWhr
35	FE77	Output Watt-Hour	0.01 kWhr
45	0006/0671	FM/AM Gain Display	1
46	FE60	My Function Monitor 1 (Unsigned Value)	1
47	FE61	My Function Monitor 2 (Unsigned Value)	1
48	FE62	My Function Monitor 3 (Signed Value)	1
49	FE63	My Function Monitor 4 (Signed Value)	1

Table 10. Input Function Target Selections and the Associated Communications Number.

Input Setting/Communication Number				Function	Resolution/ Unit
FM/AM/FP Input Setting	Comm. Number	Monitor Display Input Setting	Comm. Number		
2000	FD00	3000	FE00	Output Frequency	0.01 Hz
2002	FD02	3002	FE02	Frequency Reference	0.01 Hz
2003	FD03	3003	FE03	Output Current	0.01%
2004	FD04	3004	FE04	DC Bus Voltage	0.01%
2005	FD05	3005	FE05	Output Voltage	0.01%
2015	FD15	3015	FE15	Compensated Frequency	0.01 Hz
2016	FD16	3016	FE16	Speed Feedback (Realtime) <i>(See Note 1)</i>	0.01 Hz
2017	FD17	3017	FE17	Speed Feedback (1 Sec Filter) <i>(See Note 1)</i>	0.01 Hz
2018	FD18	3018	FE18	Torque <i>(See Note 2)</i>	0.01%
2019	FD19	3019	FE19	Torque Command <i>(See Note 2)</i>	0.01%
2020	FD20	3020	FE20	Torque Current <i>(See Note 2)</i>	0.01%
2021	FD21	3021	FE21	Excitation Current	0.01%
2022	FD22	3022	FE22	PID Feedback Value	0.01 Hz
2023	FD23	3023	FE23	Motor Overload Ratio	0.01%
2024	FD24	3024	FE24	ASD Overload Ratio	0.01%
2025	FD25	3025	FE25	DBR Overload Ratio	1%
2028	FD28	3028	FE28	DBR Load Ratio	1%
2029	FD29	3029	FE29	Input Power	0.01 kW
2030	FD30	3030	FE30	Output Power	0.01 kW
		3031	FE31	Pattern Operation Group Number	0.1
		3032	FE32	Pattern Operation Cycles Remaining	1
		3033	FE33	Pattern Operation Preset Speed Number	1
		3034	FE34	Pattern Operation Preset Speed Time Remaining	0.1
2050	FD50			Light-Load High-Speed Load Torque Monitor 1	0.01%
2051	FD51			Light-Load High-Speed Load Torque Monitor 2	0.01%
		3035	FE35	RR Input	1%
		3036	FE36	V/I Input	1%
		3037	FE37	RX Input <i>(See Note 2)</i>	1%
		3038	FE38	RX2 Option (AI1) Input <i>(See Note 2)</i>	1%
		3039	FE39	RX2 Option (AI1) Input	1%
		3040	FE40	FM Output	1
		3041	FE41	AM Output	1

Note 1: If no PG feedback is used an estimated speed value is displayed.

Note 2: My Function cannot process negative values — A negative value is processed by My Function as an absolute value.

Table 10. (Continued) **Input Function Target** Selections and the Associated Communications Number.

Input Setting/Communication Number				Function	Resolution/ Unit	
FM/AM/FP Input Setting	Comm. Number	Monitor Display Input Setting	Comm. Number			
3050	FE50			Communication Data Output 2		
3051	FE51			Communication Data Output 1		
3052	FE52			Communication Data Output 3		
3060	FE60			My Function Monitor 1 (Output of Unsigned Value)		
3061	FE61			My Function Monitor 2 (Output of Unsigned Value)		
3062	FE62			My Function Monitor 3 (Output of Signed Value)		
3063	FE63			My Function Monitor 4 (Output of Signed Value)		
		3066	FE66	Expansion I/O Card 1 CPU Version		
		3067	FE67	Expansion I/O Card 2 CPU Version		
		3076	FE76	Integral Input Power		0.01 kW
		3077	FE77	Integral Output Power		0.01 kW
		3084	FE84	16-Bit BIN/BCD Input Value		1

Table 11. My Function Operator Selections.

My Function Computational Selections		
Input Function Command	Function Name	Function Description
0	NOP (No Operation)	Disables the My Function feature.
1	ST	Execute data read/transfer.
2	STN	Execute inverted data read/transfer.
3	AND	Logical product of A AND B.
4	ANDN	Logical product of A AND \bar{B} .
5	OR	Logical sum of A OR B.
6	ORN	Logical sum of A OR \bar{B} .
7	EQ	Compares data — Outputs 1 if Equal; 0 if not Equal.
8	NE	Compares data — Outputs 0 if Equal; 1 if not Equal.
9	GT	Compares data — Outputs 1 if $A > B$; 0 if $A \leq B$.
10	GE	Compares data — Outputs 1 if $A \geq B$; 0 if $A < B$.
11	LT	Compares data — Outputs 1 if $A < B$; 0 if $A \geq B$.
12	LE	Compares data — Outputs 1 if $A \leq B$; 0 if $A > B$.
13	ASUB	Outputs absolute difference between A and B — $ A - B $
14	ON (Timer)	Enables the On response time delay settings of My Function Time Data 1 – 5 (F928 – F932) for My Function Data .
15	OFF (Timer)	Enables the Off response time delay settings of My Function Time Data 1 – 5 (F928 – F932) for My Function Data .
16	COUNT1 (Timer)	Outputs a 1 upon reaching the pulse count setting of F933.
17	COUNT2 (Timer)	Outputs a 1 upon reaching the pulse count setting of F934.
18	HOLD	Outputs the peak output value since powering up or since the last reset.
19	SET	Sets data.
20	RESET	Resets data.

Alarms, Trips, and Troubleshooting

Alarms and Trips

This section lists the available user-notification codes of the EOI display and provides information that assists the user in the event that a **Fault** is incurred. The **User Notification** codes are displayed as an indication that a system function or system condition is active (i.e., ATN, DB, and DBON). The code is displayed on the EOI for the duration of the activation.

If a user setting or an H9 ASD parameter has been exceeded, or if a data transfer function produces an unexpected result, a condition that is referred to as a **Fault** is incurred.

An **Alarm** is an indication that a **Fault** is imminent if existing operating conditions continue unchanged. An **Alarm** may be associated with an output terminal to notify the operator of the condition remotely, close a contact, or engage a brake. At the least, an **Alarm** will cause an alarm code to appear on the EOI display. [Table 13](#) lists the **Alarm** codes that may be displayed during operation of the H9 ASD.

In the event that the condition that caused the **Alarm** does not return to its normal operating level within a specified time, the ASD **Faults** and a **Trip** is incurred (**Fault** and **Trip** are sometimes used interchangeably).

A **Trip** is a safety feature (the result of a **Fault**) that disables the H9 ASD system and removes the 3-phase power to the motor in the event that a subsystem of the ASD is malfunctioning, or one or more of the variables listed below exceeds its normal range (time and/or magnitude).

- Current,
- Voltage,
- Speed,
- Temperature,
- Torque, or
- Load.

See [Table 14 on pg. 248](#) for a listing of the potential **Trips** and the associated probable causes.

The operating conditions at the time of the trip may be used to help determine the cause of the trip. Listed below are operating conditions that may be used to assist the operator in correcting the problem or that the H9 ASD operator should be prepared to discuss when contacting the TIC Customer Support Center for assistance.

- What trip information is displayed?
- Is this a new installation?
- Has the system ever worked properly and what are the recent modifications (if any)?
- What is the ASD and Motor size?
- What is the CPU version and revision level?
- What is the EOI version?
- Does the ASD trip when accelerating, running, decelerating, or when not running?
- Does the ASD reach the commanded frequency?
- Does the ASD trip without the motor attached?
- Does ASD trip with an unloaded motor?

User Notification Codes

The **User Notification** codes appear in the top right corner of the **Frequency Command** screen while the associated function is active.

User Notification codes notify the user of active functions that are usually only momentary under normal conditions and are active for the duration of activation only. User notification events are not error conditions and only convey active system functions to the user.

Table 12. User Notification Codes.

LED	Function	Description
Atn	Autotune active	Atn indicates that the Autotune function is active.
dbOn	DC Braking	This code conveys the DC Injection function being carried out. The display shows db when braking and shows dbOn when the motor shaft stationary function is being carried out.

Alarms

Table 13 lists the alarm codes that may be displayed during operation of the H9 ASD. Each alarm code listed is accompanied by a description and a possible cause. In the event that the source of the malfunction cannot be determined, contact your TIC Sales Representative for further information on the condition and for an appropriate course of action.

The **Alarms** are listed in the top-down order that they are checked for activation. Only the first to be detected will be displayed on the **Frequency Command** screen.

Table 13. H9 ASD Alarms.

LED Screen	LCD Screen	Description	Possible Causes
CM1	Comm1 Error	Internal communications error.	<ul style="list-style-type: none"> Improperly programmed ASD. Improper communications settings. Improperly connected cables.
CM2	Comm2 Error	External communications error.	
E	Emergency Off	Output signal from the ASD is terminated and a brake may be applied if so configured.	<ul style="list-style-type: none"> Stop/Reset pressed twice at the EOI. EOFF command received remotely. ASD reset required.
MOFF	Main Under-Voltage	Under-voltage condition at the 3-phase AC input to the ASD.	<ul style="list-style-type: none"> Low 3-phase commercial voltage.
OC	Over-Current	ASD output current greater than F601 setting.	<ul style="list-style-type: none"> Defective IGBT (U, V, or W). ASD output to the motor is connected incorrectly. ASD output phase-to-phase short. The ASD is starting into a spinning motor. Motor/machine jammed. Mechanical brake engaged while the ASD is starting or while running. Accel/Decel time is too short. Voltage Boost setting is too high. Load fluctuations. ASD operating at an elevated temperature.
*OH	Overheat	ASD ambient temperature excessive.	<ul style="list-style-type: none"> ASD is operating at an elevated temperature. ASD is too close to heat-generating equipment. Cooling fan vent is obstructed (see Mounting the ASD on pg. 15). Cooling fan is inoperative. Internal thermistor is disconnected.
OJ	Timer	Run-time counter exceeded.	<ul style="list-style-type: none"> Type Reset required; select Clear run timer.
* Reset ignored if active.			

LED Screen	LCD Screen	Description	Possible Causes
*OLI	ASD Overload	Load requirement in excess of the capability of the ASD.	<ul style="list-style-type: none"> The carrier frequency is too high. An excessive load. Acceleration time is too short. DC damping rate is set too high. The motor is starting into a spinning load after a momentary power failure. The ASD is improperly matched to the application.
OLM	Motor Overload	Load requirement in excess of the capability of the motor.	<ul style="list-style-type: none"> V/f parameter improperly set. Motor is locked. Continuous operation at low speed. The load is in excess of what the motor can deliver.
*OLR	Resistor Overload	Excessive current at the Dynamic Braking Resistor .	<ul style="list-style-type: none"> Deceleration time is too short. DBR configuration improperly set.
*OP	Over-Voltage	DC bus voltage exceeds specifications.	<ul style="list-style-type: none"> ASD attempting to start into a spinning motor after a momentary power loss. Incoming commercial power is above the specified range. Decel time is too short. Voltage spikes at the 3-phase input; install inductive filter. DBR required. DBR resistance value is too high. DBR function is turned off. Over-Voltage Stall feature is turned off. System is regenerating. Load instability. Disable the Ridethrough function (F302).
OT	Over-Torque	Torque requirement is in excess of the setting of F616 or F617 for a time longer than the setting of F618.	<ul style="list-style-type: none"> ASD is not correctly matched to the application. F616 or F617 setting is too low. Obstructed load.
*POFF	Control Under-Voltage	Under-voltage condition at the 5, 15, or the 24 VDC supply.	<ul style="list-style-type: none"> Defective Control board. Excessive load on power supply. Low input voltage.
PtSt	Reference Point	Two speed-reference frequency setpoint values are too close to each other.	<ul style="list-style-type: none"> Two speed reference frequency setpoints are too close to each other (increase the difference).
UC	Under-Current	With the Low-Current Trip (F610) parameter enabled, the output current of the ASD is below the level defined at F611 and remains there for a time longer than the setting of F612.	<ul style="list-style-type: none"> Output current too low.

* Reset ignored if active.

Trips/Faults

A **Trip** is an H9 ASD response to a **Fault** (though **Fault** and **Trip** are sometimes used interchangeably). A **Trip** is a safety feature that disables the ASD system in the event that a subsystem of the ASD is malfunctioning or a parameter setting has been exceeded.

Listed in [Table 14](#) are the **Faults** that may result in a **Trip** and the possible causes. When a **Trip** is incurred the system displays the **Fault** screen. The **Fault** screen identifies the active **Fault**.

Table 14. H9 ASD Fault Listing.

LED Screen	LCD Screen	Possible Causes
E	Emergency Off	<ul style="list-style-type: none"> Emergency Off command received via EOI or remotely.
E-10	Sink/Source Setting Error	<ul style="list-style-type: none"> Improperly positioned Sink/Source jumper on the Terminal board or on an option device (see J100 at the Terminal PCB of the ASD). Sink/Source configuration is incorrect.
E-11	Brake Sequence Response Error	<ul style="list-style-type: none"> F630 is set to a non-zero value. Braking sequence discrete input and output terminals are not setup properly.
E-12	Encoder Signal-Loss Error	<ul style="list-style-type: none"> ASD is configured to receive a signal from a shaft-mounted encoder and no signal is being received while running. Disconnection at the Encoder circuit. Motor is stopped and is generating torque via torque limit control. ASD is not configured properly.
E-13	Speed Error	<ul style="list-style-type: none"> Result of a motor speed that is greater than the commanded speed when using an encoder for speed control. Improper encoder connection or setup information. Defective encoder.
E-17	Key Failure	<ul style="list-style-type: none"> Same key input for 20 seconds or more.
E-18	Analog (Terminal) Input Loss	<ul style="list-style-type: none"> V/I signal loss. Terminal Board failure. P24 over-current condition. F633 setting is too high.
E-19	CPU Communication Error	<ul style="list-style-type: none"> CPU data Transmit/Receive error.
E-20	V/f Control Error	<ul style="list-style-type: none"> Torque processing error. Make service call.
E-21	CPU Processing Error	<ul style="list-style-type: none"> Software processed incorrectly. Make service call.
E-22	Logic Input Voltage Error	<ul style="list-style-type: none"> Incorrect voltage applied to the discrete input terminals.
E-23	Optional Expansion Input Terminal Board 1 Error	<ul style="list-style-type: none"> Optional Expansion Input Terminal Board 1 is defective.
E-24	Optional Expansion Input Terminal Board 2 Error	<ul style="list-style-type: none"> Optional Expansion Input Terminal Board 2 is defective.

LED Screen	LCD Screen	Possible Causes
E-25	Stop Positioning Retention Error	<ul style="list-style-type: none"> • Load movement while stopped. • F381 setting is too low. • Encoder malfunction. • Creep speed is too high.
E-26	CPU2 Fault	<ul style="list-style-type: none"> • CPU malfunction. • Control board malfunction.
E-50/E-51	Sink/Source Setting Error	<ul style="list-style-type: none"> • Improperly positioned Sink/Source jumper on the Terminal board or on an option device (see J100 at the Terminal PCB of the ASD). • Sink/Source configuration is incorrect.
EEP1	EEPROM Fault	<ul style="list-style-type: none"> • EEPROM write malfunction. • Make a service call.
EEP2/EEP3	EEPROM Read Error	<ul style="list-style-type: none"> • EEPROM read malfunction. • Make a service call.
EF1/EF2	(Earth) Ground Fault	<ul style="list-style-type: none"> • Ground fault at the motor. • Ground fault at the output of the ASD. • Current leakage to Earth Ground.
EPHI	Input Phase Failure	<ul style="list-style-type: none"> • 3-phase input to the ASD is low or missing at the R, S, or T input terminals.
EPHO	Output Phase Failure	<ul style="list-style-type: none"> • 3-phase output from the ASD is low or missing at the U, V, or W output terminals or at the input to the motor.
ERR2	RAM Fault	<ul style="list-style-type: none"> • Internal RAM malfunction. • Make a service call.
ERR3	ROM Fault	<ul style="list-style-type: none"> • Internal ROM malfunction. • Make a service call.
ERR4	CPU Fault	<ul style="list-style-type: none"> • CPU malfunction. • Control board malfunction. • Make a service call.
ERR5	Communication Error	<ul style="list-style-type: none"> • Communication time out error. • Communication malfunction. • Improper or loose connection. • Improper system settings.
ERR6	Gate Array Fault	<ul style="list-style-type: none"> • Main Gate Array is defective.
ERR7	Low -Current	<ul style="list-style-type: none"> • Improper Low- Current detection level settings at F609 – F612.
ERR8	Option Device Fault	<ul style="list-style-type: none"> • Check installation, connections, and option device manual.
ERR9	Flash Memory Fault	<ul style="list-style-type: none"> • Flash memory malfunction. • Make a service call.

LED Screen	LCD Screen	Possible Causes
ETN	Autotune Error	<ul style="list-style-type: none"> • Autotune readings that are significantly inconsistent with the configuration information. • A non-3-phase motor is being used. • Incorrect settings at F400 or F413. • Using a motor that has a significantly smaller rating than the ASD. • ASD output cabling is too small, too long, or is being housed in a cable tray with other cables that are producing an interfering EMF. • Motor is running during the Autotune function.
ETN1		<ul style="list-style-type: none"> • F402 adjustment required (Motor temperature is too high). • F410 adjustment required (Motor Constant 1 improperly set).
ETN2		<ul style="list-style-type: none"> • F412 adjustment required (Motor Constant 3 improperly set).
ETN3		<ul style="list-style-type: none"> • Autotune setting F400 is set to Auto Calculation and there is a problem with the Motor Constant readings.
ETYP	Typeform Error	<ul style="list-style-type: none"> • Firmware information (typeform) loaded into the Gate Driver board is inconsistent with the device in which the firmware is being used. • The Gate Driver board has been replaced. • The Gate Driver board is defective.
None	No Errors	<ul style="list-style-type: none"> • No active faults.
OC1	Over-Current During Acceleration	<ul style="list-style-type: none"> • Improper V/f setting. • Restart from a momentary power outage. • The ASD is starting into a rotating motor. • ASD/Motor not properly matched. • Phase-to-phase short (U, V, or W). • Accel time too short. • Voltage Boost setting is too high. • Motor/machine jammed. • Mechanical brake engaged while the ASD is running. • ASD current exceeds 340% of the rated FLA on ASDs that are 100 HP or less during acceleration. On ASDs that are greater than 100 HP, this fault occurs when the ASD current exceeds 320% of the rated FLA during acceleration.
OC1P	Overheat During Acceleration	<ul style="list-style-type: none"> • Cooling fan inoperative. • Ventilation openings are obstructed. • Internal thermistor is disconnected. • Acceleration time is too short. • Improper V/f setting. • ASD or the motor is improperly matched to the application.

LED Screen	LCD Screen	Possible Causes
OC2	Over-Current During Deceleration	<ul style="list-style-type: none"> Phase-to-phase short (U, V, or W). Deceleration time is too short. Motor/machine jammed. Mechanical brake engaged while the ASD is running. ASD current exceeds 340% of the rated FLA on ASDs that are 100 HP or less during deceleration. On ASDs that are greater than 100 HP, it occurs when the ASD current exceeds 320% of the rated FLA during deceleration.
OC2P	Overheat During Deceleration	<ul style="list-style-type: none"> Cooling fan inoperative. Ventilation openings are obstructed. Internal thermistor is disconnected. Deceleration time is too short. DC Injection current is too high. ASD or the motor is improperly matched to the application.
OC3	Over-Current During Run	<ul style="list-style-type: none"> Load fluctuations. ASD is operating at an elevated temperature. ASD current exceeds 340% of the rated FLA on ASDs that are 100 HP or less during a fixed-speed run or if during a fixed-speed run the ASD overheats. On ASDs that are greater than 100 HP, it occurs when the ASD current exceeds 320% of the rated FLA on a fixed-speed run.
OC3P	Overheat During Run	<ul style="list-style-type: none"> Cooling fan inoperative. Ventilation openings are obstructed. Internal thermistor is disconnected. Improper V/f setting. ASD or the motor is improperly matched to the application.
OCA1 or OCL	U-Phase Over-Current	<ul style="list-style-type: none"> Low impedance at the U lead of the ASD output.
OCA2 or OCL	V-Phase Over-Current	<ul style="list-style-type: none"> Low impedance at the V lead of the ASD output.
OCA3 or OCL	W-Phase Over-Current	<ul style="list-style-type: none"> Low impedance at the W lead of the ASD output.
OCR	Dynamic Braking Resistor Over-Current	<ul style="list-style-type: none"> ASD inability to discharge the bus voltage during regeneration. No dynamic braking resistor (DBR) installed. Deceleration time is too short. Improper DBR setup information. Defective IGBT7 (or IGBT7 ckt.). 3-phase input voltage is above specification.
OH	Overheat	<ul style="list-style-type: none"> Cooling fan inoperative. Ventilation openings are obstructed. Internal thermistor is disconnected.
OH2	External Overheat	<ul style="list-style-type: none"> Excessive-heat signature received at the TB3 – TH1(+) and TH1(-) terminals. See F637 for setup information.

LED Screen	LCD Screen	Possible Causes
OL1	ASD Overload	<ul style="list-style-type: none"> • Acceleration time is too short. • DC Injection current is too high. • Improper V/f setting. • Motor running during restart. • ASD or the motor is improperly matched to the application.
OL2	Motor Overload	<ul style="list-style-type: none"> • Improper V/f setting. • Motor is locked. • Continuous operation at low speed. • Load requirement exceeds ability of the motor. • Startup frequency setting adjustment required.
OLR	Dynamic Braking Resistor Overload	<ul style="list-style-type: none"> • Deceleration time is too short. • DBR setting adjustment required. • Over-Voltage Stall setting adjustment required.
OP1	Over-Voltage During Acceleration	<ul style="list-style-type: none"> • Motor running during restart.
OP2	Over-Voltage During Deceleration	<ul style="list-style-type: none"> • Deceleration time is too short. • DBR value is too high. • DBR required (DBR setup required). • Stall protection is disabled. • 3-phase input voltage is out of specification. • Input reactance required.
OP3	Over-Voltage During Run	<ul style="list-style-type: none"> • Load fluctuations. • 3-Phase input voltage out of specification. • DBR required (DBR setup required).
OT	Over-Torque	<ul style="list-style-type: none"> • A torque requirement by the load in excess of the setting of F616 or F617 for a time longer than the setting of F618. • The ASD is improperly matched to the application. • The load is obstructed.
SOUT	Step-Out (for PM Motor Only)	<ul style="list-style-type: none"> • Motor shaft is locked. • Output phase is open. • Operating a reciprocating load.
UP1	Main Power Under-Voltage	<ul style="list-style-type: none"> • Input 3-phase voltage is too low. • Momentary power failure longer than the time setting of F628.
UP2	Control Power Under-Voltage	<ul style="list-style-type: none"> • This fault is caused by an under-voltage condition at the 5, 15, or the 24 VDC supply. • 3-phase input voltage low.

Viewing Trip Information

In the event that the condition causing an **Alarm** does not return to the normal operating level within a specified time, the H9 ASD **Faults** and a **Trip** is incurred.

When a trip occurs, the resultant error information may be viewed either from the LED screen, LCD **Fault** screen (Table 14 on pg. 248), **Monitor** screen, or the **Trip History** screen (Program ⇒ Utilities ⇒ [Trip History](#)).

Trip Record at Monitor Screen

The at-trip condition of the last 4 incurred trips may be viewed at the **Monitor** screen. The **Monitor** screen displays the records of up to four trips and catalogs each trip as **Past Trip 1** through **Past Trip 4** (see pg. 44). Once reset (**Type Reset**), the trip records are erased. If no trips have occurred since being powered up or since the last reset, **None** is displayed for each trip record.

The **Monitor** screen at-trip record is erased when the H9 ASD is reset.

Note: *An improper H9 ASD setup may cause some trips — reset the ASD to the **Factory Default** settings before pursuing a systemic malfunction (Program ⇒ Utilities ⇒ Type Reset ⇒ **Reset to Factory Settings**).*

Trip History

The **Trip History** screen records the system parameters for up to 20 trips. The recorded trips are numbered from zero to 19. Once the **Trip History** record reaches trip number 19, the oldest recorded trip will be deleted with each new record stored (first-in first-out). The **Trip #** field may be selected and scrolled through to view the recorded trip information for a given trip number. The monitored parameters are listed in Table 15 as **At-trip Recorded Parameters** (parameter readings at the time that the trip occurred).

In the event of a power loss or if the keypad has been removed from the ASD, the trip records and the real-time clock information are retained within the keypad for up to 4.5 years via [Battery Backup](#).

Table 15. Trip History Record Parameters.

At-trip Recorded Parameters			
1) Trip Number	8) Frequency Reference	15) Feedback (1 sec.)	22) ASD Overload
2) Trip Type	9) Bus Voltage	16) Torque	23) DBR Overload
3) Time and Date	10) Discrete Input Status	17) Torque Reference	24) Motor Load
4) Frequency at Trip	11) OUT1/OUT2/FL Status	18) Torque Current	25) ASD Load
5) Output Current	12) Timer	19) Excitation Current	26) DBR Load
6) Output Voltage	13) Post Compensation Frequency	20) PID Value	27) Input Power
7) Direction	14) Feedback (inst.)	21) Motor Overload	28) Output Power
Trip records are comprised of the full list of monitored parameters (28).			

Clearing a Trip

Once the cause of the trip has been corrected, performing a [Reset](#) re-enables the H9 ASD for normal operation.

The record of a trip may also be cleared using either of the following methods:

- Cycling power (trip info may be saved via [F602](#) if desired),
- Pressing the **Stop-Reset** key twice,
- Remotely via the communications channel,
- Momentarily connecting terminal **RES** to **CC** of the **Terminal Board**, or
- Via Program ⇒ Utilities ⇒ Type Reset ⇒ **Clear Past Trip** (clears Monitor screen records only).

Enclosure and Conduit Plate Dimensions

The H9 ASD part numbering convention is shown below.

The enclosure dimensions for the available models (typeforms) are listed in [Tables 16](#) and [17](#). The conduit plates referenced are shown in [Figures 34](#), [35](#), and [36](#).

H9 Part Numbering Convention.

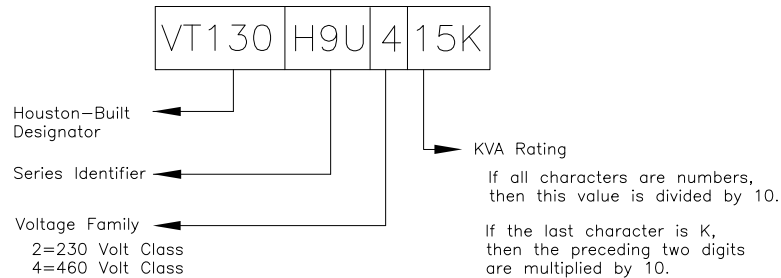

Note: The Type I enclosed versions of these drives meet or exceed the specification **UL 50-1995, the Standard for Heating and Cooling Equipment**, and complies with the applicable requirements for installation in a compartment handling conditioned air.

Enclosure Dimensions

Table 16. 230-Volt H9 ASD Systems.

Frame	Model Number VT130H9U	Enclosure Figure Number	A Width (in/mm)	B Height (in/mm)	C Depth (in/mm)	Mounting Hole Dimensions (in/mm)				Conduit Plate	
						D	E	R1	R2		
2	2010	Figure 31	5.2/132	11.2/285	6.1/155	8.7/220	4.5/114	0.098/2.5	0.217/5.5	Figure 34-A	
	2015										
	2025										
3	2035		6.1/155	12.4/315	6.6/168	9.8/249	5.4/138	0.236/6.0	Figure 34-B		
	2055										
4	2080		6.9/175	15.0/381	7.6/193	11.1/283	6.2/158	0.118/3.0	0.276/7.0		Figure 34-D
	2110										
5B	2160		Figure 32	11.1/283	25.9/658	13.2/335	25.0/635	8.0/203	0.188/4.8	0.375/9.5	
	2220										
	2270										
7B	2400	Figure 33	14.3/363	33.1/841	15.0/381	32.3/820	9.2/234	0.344/8.7	0.670/17	Figure 35-G	
	2500										
	2600										
	2750										
9	210K	Figure 33	14.6/371	51.7/1313	17.6/447	50.2/1275	9.2/234	0.344/8.7	0.670/17	Figure 35-I	
10	212K		15.7/399	53.1/1349		51.7/1313	9.9/252			Figure 35-J	

Table 17. 460-Volt H9 ASD Systems.

Frame	Model Number VT130H9U	Enclosure Figure Number	A Width (in/mm)	B Height (in/mm)	C Depth (in/mm)	Mounting Hole Dimensions (in/mm)				Conduit Plate	
						D	E	R1	R2		
2	4015	Figure 31	5.2/132	11.2/285	6.1/155	8.7/220	4.5/114	0.098/2.5	0.217/5.5	Figure 34-A	
	4025										
	4035										
3	4055		6.1/155	12.4/315	6.6/168	9.8/249	5.4/138	0.118/3.0	0.276/7.0	Figure 34-B	
	4080										
4	4110		6.9/175	15.0/381	7.6/193	11.1/283	6.2/158	0.118/3.0	0.276/7.0	Figure 34-C	
5A	4160		8.3/211	15.1/384							
	4220		9.1/231	19.3/490							15.2/386
5B	4330										
6	4400		Figure 32	11.1/283	25.9/658	13.2/335	25.0/635	8.0/203	0.188/4.8	0.375/9.5	Figure 34-E
7A	4500				30.8/782	14.3/363	29.7/754				Figure 34-F
	4600				14.3/363	36.1/917	15.3/389				35.3/897
8	4750										
	410K										
	412K										
9	415K	Figure 33	14.6/371	51.7/1313	17.6/447	50.2/1275	9.2/234	0.344/8.7	0.670/17	Figure 35-I	
10	420K		15.7/399	53.1/1349		51.7/1313	9.9/252			Figure 35-J	
11	425K		15.0/381	63.1/1603		61.6/1565				Figure 35-K	
12	430K		18.9/480	68.5/1740		67.0/1701	13.8/351			Figure 36-L	
	435K		25.6/650	70.0/1778		68.5/1740	21.3/541			Figure 36-M	
13	440K										

Figure 31. See [Tables 16](#) and [17](#) for Actual Dimensions.

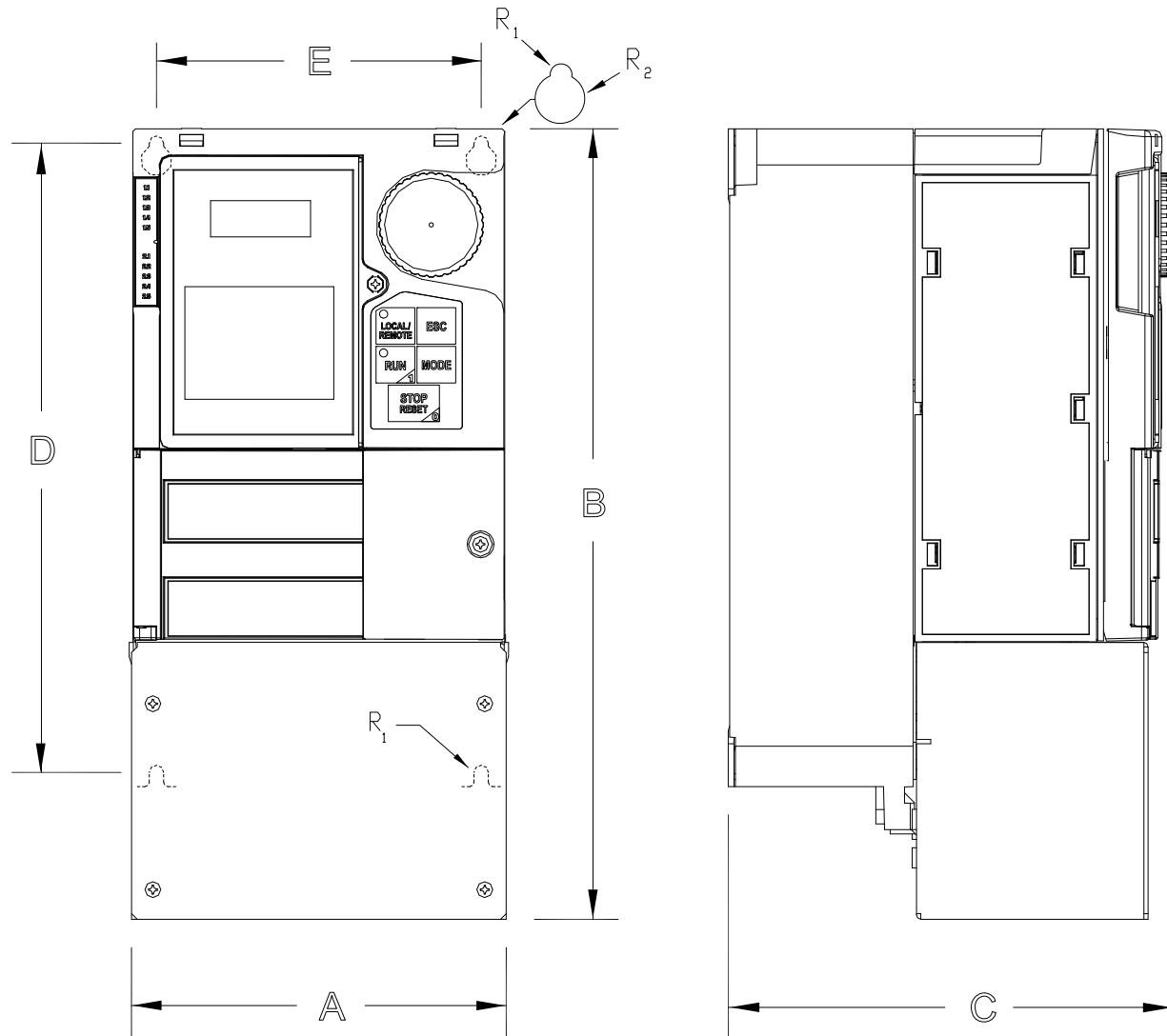

Figure 32. See [Tables 16](#) and [17](#) for Actual Dimensions.

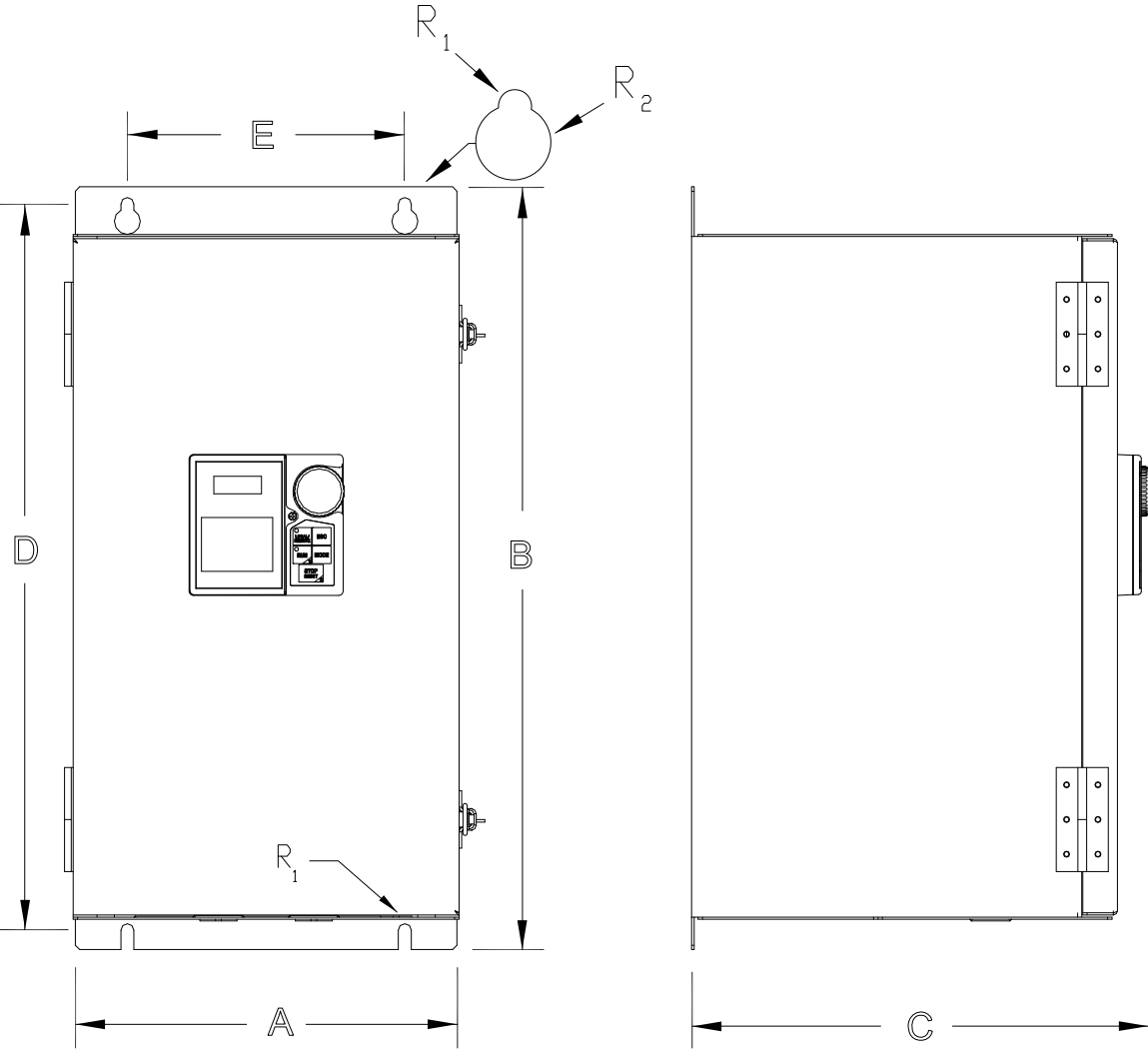
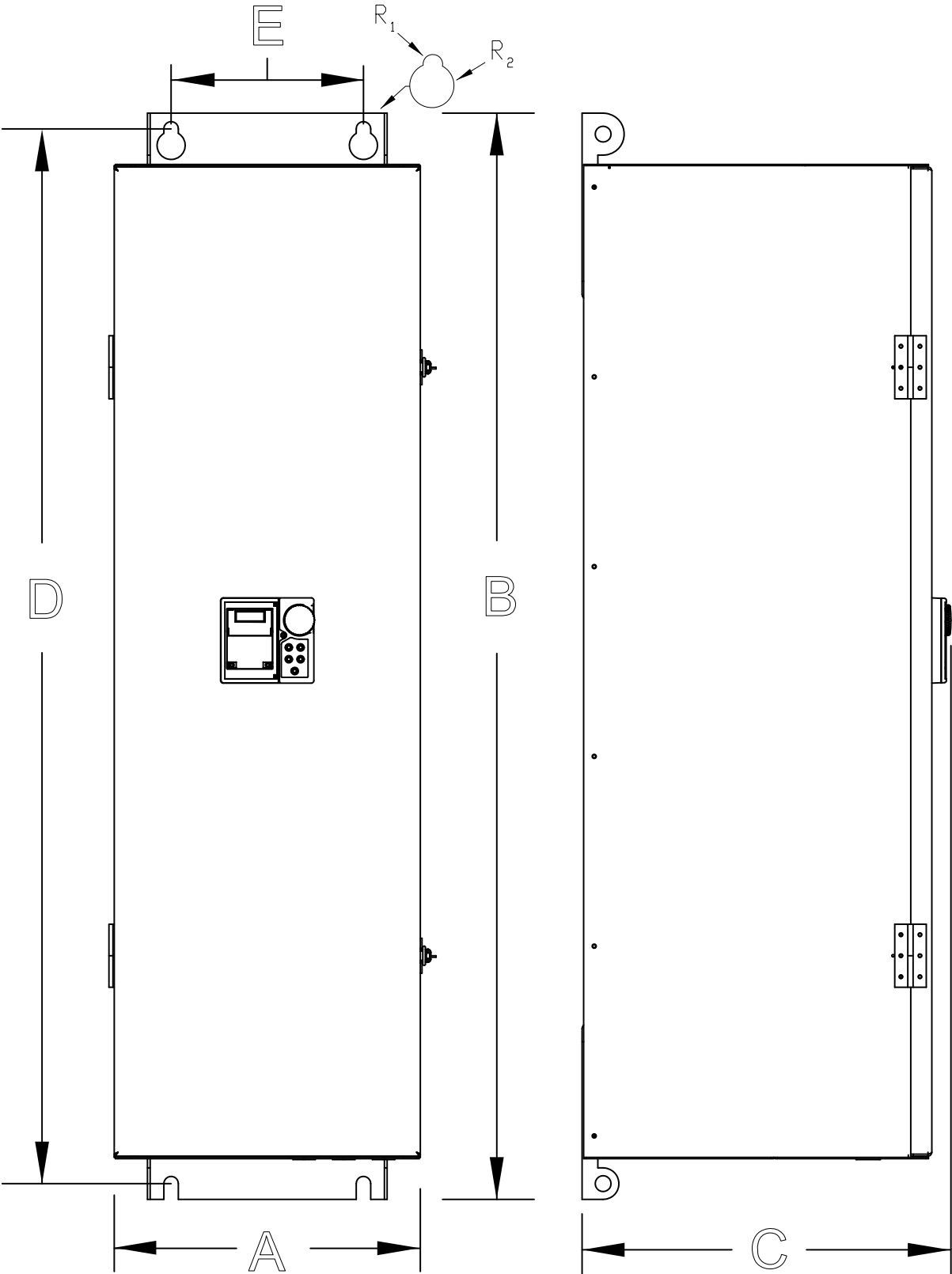

Figure 33. See [Tables 16](#) and [17](#) for Actual Dimensions.



Conduit Plate Dimensions

Figure 34. See [Tables 16](#) and [17](#) for the associated device. Dimensions are in in/cm.

ØX = Concentric Knockouts for Diameter Sizes 0.5", 0.75", and 1.0" Conduit.

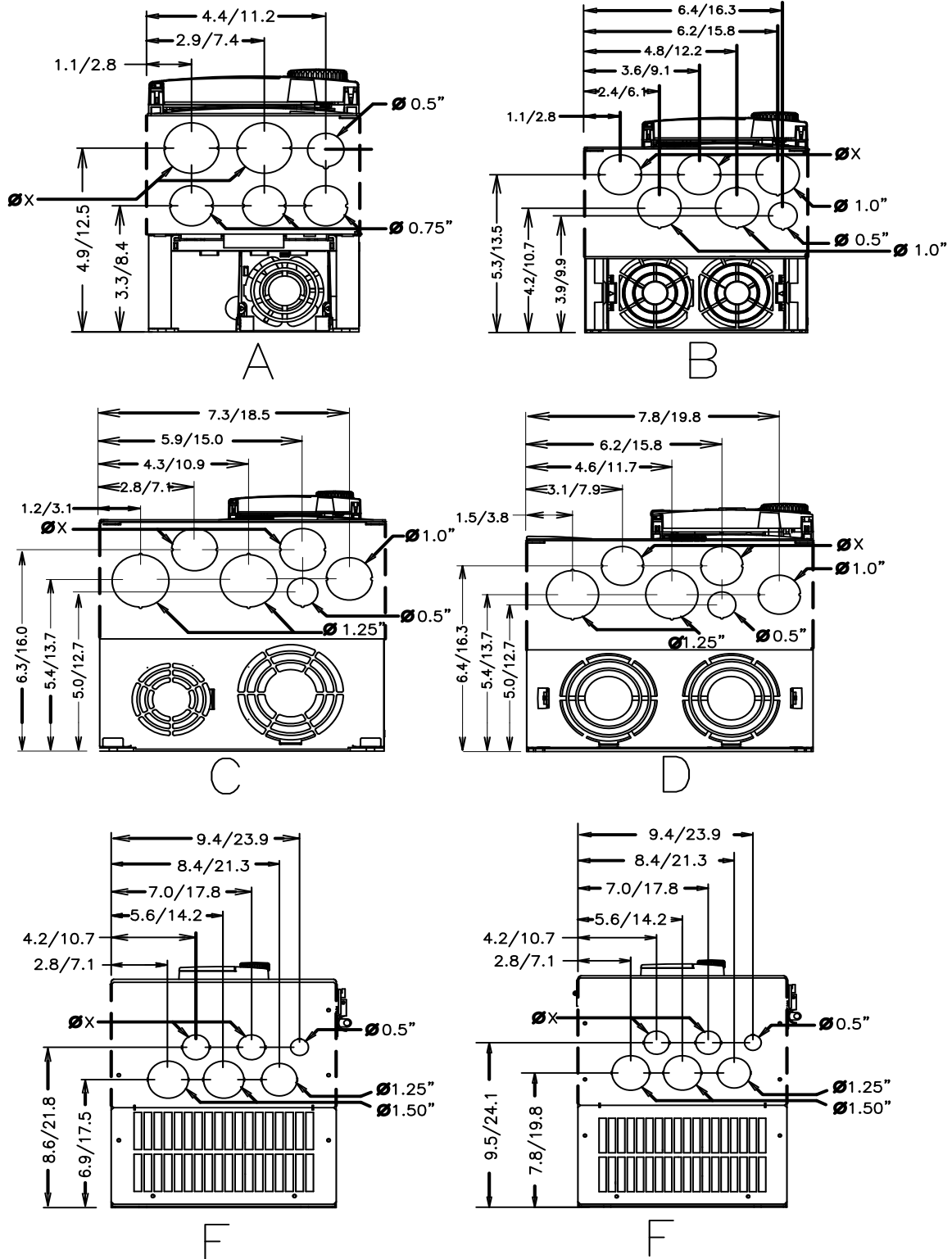
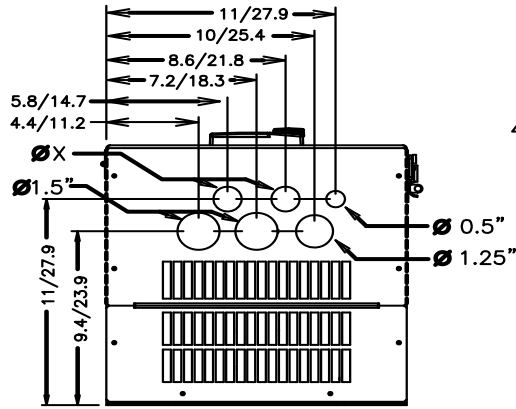
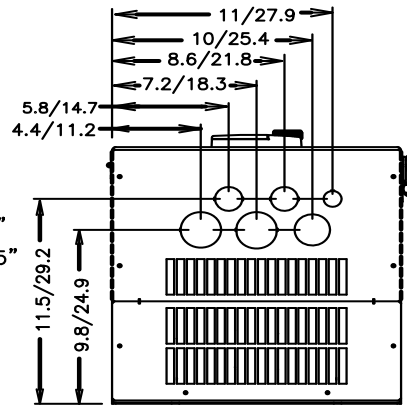

Figure 35. See Tables 16 and 17 for the associated device. Dimensions are in in/cm.

ØX = Concentric Knockouts for Diameter Sizes 0.5", 0.75", and 1.0" Conduit.



G



Conduit Ø = Same as G

H

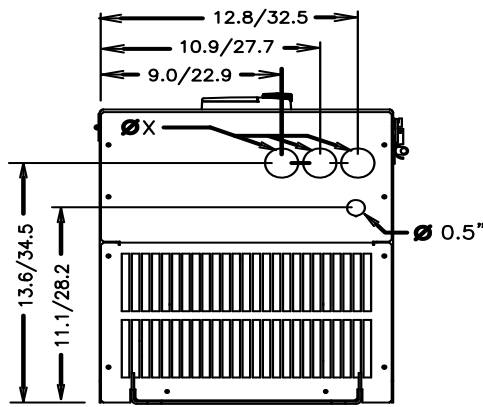

I

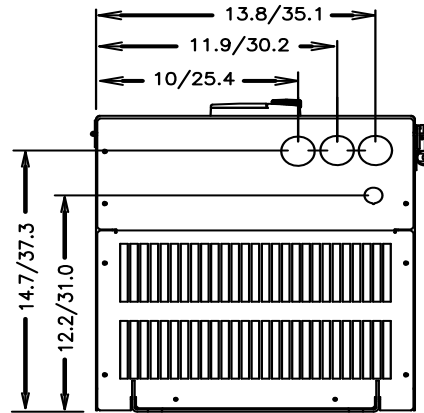

Conduit Ø = Same as I

J

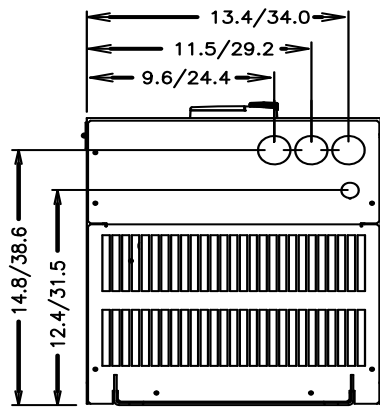

Conduit Ø = Same as I

K

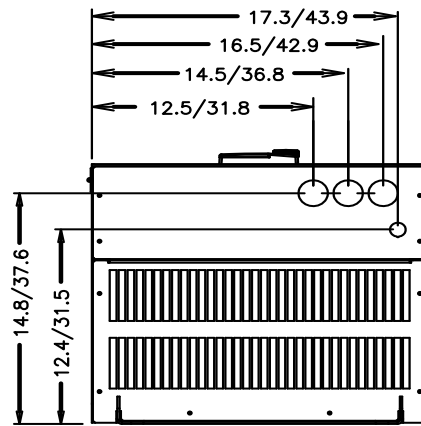

Conduit Ø = Same as I

L

Figure 36. See [Table 17](#) for the associated device. Dimensions are in in/cm.

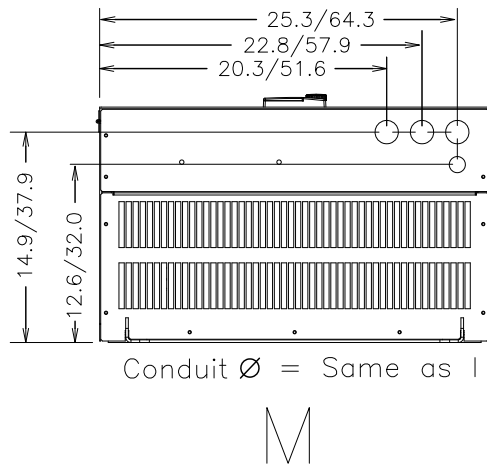

Current/Voltage Specifications

Table 18. 230-Volt Chassis Standard Ratings Table.

Model Number VT130H9U	Typical Motor HP	100% Output Current Continuous	Overload Current 120% for 60 Seconds	Input Voltage 3-Ph 50/60 ± 2 Hz	Output Voltage 3-Ph Variable Frequency
2010	0.75	3.2 A	3.84 A	200–240 VAC ($\pm 10\%$)	Input Voltage Level (Max.)
2015	1.0	4.2 A	5.04 A		
2025	2.0	6.8 A	8.16 A		
2035	3.0	9.6 A	11.5 A		
2055	5.0	15.2 A	18.2 A		
2080	7.5	22.0 A	26.0 A		
2110	10	28.0 A	34.0 A		
2160	15	42.0 A	50.0 A		
2220	20	54.0 A	65.0 A		
2270	25	68.0 A	82.0 A		
2330	30	80.0 A	96.0 A		
2400	40	104 A	125 A		
2500	50	130 A	156 A		
2600	60	154 A	185 A		
2750	75	192 A	230 A		
210K	100	248 A	298 A		
212K	125	312 A	374 A		

Table 19. 460-Volt Chassis Standard Ratings Table.

Model Number VT130H9U	Typical Motor HP	100% Output Current Continuous	Overload Current 120% for 60 Seconds	Input Voltage 3-Ph 50/60 ±2 Hz	Output Voltage 3-Ph Variable Frequency
4015	1.0	2.1 A	2.52 A	380 – 480 VAC (±10%)	Input Voltage Level (Max.)
4025	2.0	3.4 A	4.08 A		
4035	3.0	4.8 A	5.76 A		
4055	5.0	7.6 A	9.00 A		
4080	7.5	11.0 A	13.0 A		
4110	10	14.0 A	17.0 A		
4160	15	21.0 A	25.0 A		
4220	20	27.0 A	32.0 A		
4270	25	34.0 A	41.0 A		
4330	30	40.0 A	48.0 A		
4400	40	52.0 A	62.0 A		
4500	50	65.0 A	78.0 A		
4600	60	77.0 A	92.0 A		
4750	75	96.0 A	115 A		
410K	100	124 A	149 A		
412K	125	156 A	187 A		
415K	150	180 A	216 A		
420K	200	240 A	288 A		
425K	250	302 A	362 A		
430K	300	361 A	433 A		
435K	350	414 A	497 A		
440K	400	477 A	572 A		

Cable/Terminal/Torque Specifications

Installation should conform to the NEC Article 110 (Requirements for Electrical Installations), all regulations of the Occupational Safety and Health Administration, and any other applicable national, regional, or industry codes and standards.

Note: The following ratings are guidelines and shall not be the sole determining factor of the lug or wire size used with the H9 ASD. Application-specific applicables, wire insulation type, conductor material, and local and regional regulations are but a few of the considerations when selecting the actual lug and wire type to be used with the H9 ASD.

Note: Cable/Terminal specifications are based on the rated current of the H9 ASD and **Do Not** include the 10% Service Factor.

Note: Use only 75° C copper wire/cable for motor and power connections.

For further installation information see the section titled [Installation and Connections](#) on pg. 14.

Table 20. 230-Volt H9 ASD Cable/Terminal/Torque Specifications.

Model Number VT130H9U	MCP Rating (Amps)	Wire/Cable Size		Lug Size Range		Terminal Board	Torque		
		AWG or kcmil						3Ø-Input	3Ø-Output
		Input/Output Power		Wire-Size/Lug-Capacity for Input/Output Power		TB1 – 4 Terminals			
		Recommended	Maximum	3Ø-Input	3Ø-Output	In-Lbs./Nm			
2010	15	14	10	14 to 8		20 (3-core shield) Torque to 5.3/0.6	11.5/1.3		
2015									
2025									
2035	30	10	12 to 8		17.7/2.0				
2055									
2080	50	8	8	8 to 3			21/2.4		
2110									
2160	75	6	3	12 to 1/0 4 to 1/0					50/5.7 53/6
2220	100	4							
2270	125	3							
2330	150	2	2	6 to 250 2 to 300		275/31 168/19			
2400	175	1/0	4/0						
2500	200	2/0							
2600	250	3/0							
2750	300	4/0	6 to 250		275/31				
210K	400	*3/0					*1/0		
212K	500	*250					*250		

Note: (*) Indicates that the item is one of a set of two parallel cables.

Table 21. 460-Volt H9 ASD Cable/Terminal/Torque Specifications.

Model Number VT130H9U	MCP Rating (Amps)	Wire/Cable Size		Lug Size Range		Terminal Board	Torque		
		AWG or kcmil						3Ø-Input	3Ø-Output
		Input/Output Power		Wire-Size/Lug-Capacity for Input/Output Power		TB1 – 4 Terminals			
		Recommended	Maximum	3Ø-Input	3Ø-Output	In-Lbs./Nm			
4015	15	14	10	14 to 8		20 (3-core shield) Torque to 5.3/0.6	11.5/1.3		
4025									
4035									
4055									
4080	20	12	8	12 to 8			17.7/2.0		
4110	30	10							
4160		8	4	10 to 4			21/2.4		
4220	50								
4270	75	4	3	8 to 3					
4330									
4400	100	3	2	12 to 1/0	4 to 1/0		50/5.7	53/6.0	
4500									
4600	125	2	4/0	6 to 250	1 to 300		275/31	168/19	
4750	175	1/0							
410K	200	2/0							
412K	250	4/0	*250	6 to 250			275/31		
415K	300	*1/0							
420K	400	*3/0							
425K	500	*250							
430K	600	*300	*350	4 to 350			375/42.4		
435K	700	*350							
440K	800	**250	**350	0 to 500	6 to 350				

Note: (*) Indicates that the item is one of a set of two parallel cables.

Note: (**) Indicates that the item is one of a set of three parallel cables.

Dynamic Braking System Specifications

Thermal protection for the DBR circuit (see [Figure 37. on pg. 267](#)) or an input contactor that will open the 3-phase power input circuit (see [Figure 38. on pg. 267](#)) to the H9 ASD in the event that a DBR over-temperature condition occurs is a requirement. Should a DBR failure or a power source over-voltage condition occur, the DBR thermal protection circuitry will prevent hazardous DBR temperatures.

To use the **Dynamic Braking** function the following requirements must be met:

- **Enable** the DBR function,
- Select a **Resistance Value**, and
- Set the **Continuous Braking Wattage** value at [F304](#), [F308](#), and [F309](#), respectively.

Set the **Braking Resistance Overload Time** at parameter [F639](#) to establish how long the braking resistor is allowed to sustain the overload condition before a trip is incurred (the factory default setting is 5 seconds).

Light-duty and heavy-duty resistors vary from a few ohms to several hundred ohms. The appropriate resistance size will be typeform- and application-specific. Contact your TIC Sales Representative or the TIC Customer Support Center for more information on your specific DBR requirements.

Heavy-duty DBRs should be wired using the same gauge wire as the motor leads. Light-duty DBRs may use one wire size smaller (AWG or kcmil) than the motor leads.

Because the heat generated by the DBR will affect the cooling capacity of the heat sink, the resistor pack should be mounted above or to the side of the ASD — **Never below the ASD**. Maintain a minimum of six inches between the resistor pack and the ASD unit.

The total wire length from the ASD to the DBR should not exceed 10 feet.

The wiring from the ASD to the DBR should be twisted approximately two twists per foot throughout the length of the wire.

If EMI/RFI noise is of concern, the DBR wiring should be 3-core screened cable. The screen should connect to the ASD enclosure and the resistor enclosure.

CAUTION

Though the in-line DBR fuse and the thermal relay are designed into the system to prevent a catastrophic DBR over-current condition, they are both intended to be used as backup protection **ONLY**.

A proper typeform-specific and application-specific system setup that includes using the appropriate **Dynamic Braking Resistor and Overload** settings will be required.

Figure 37. Braking Resistor Circuit With a Thermal Fuse.

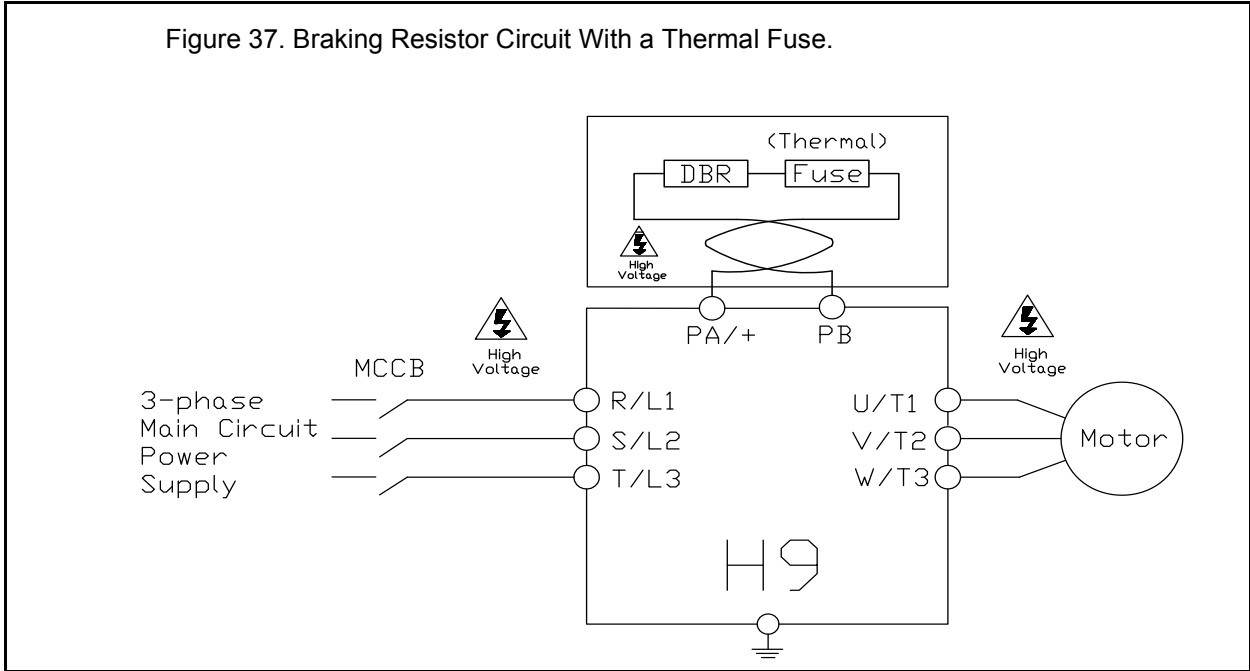
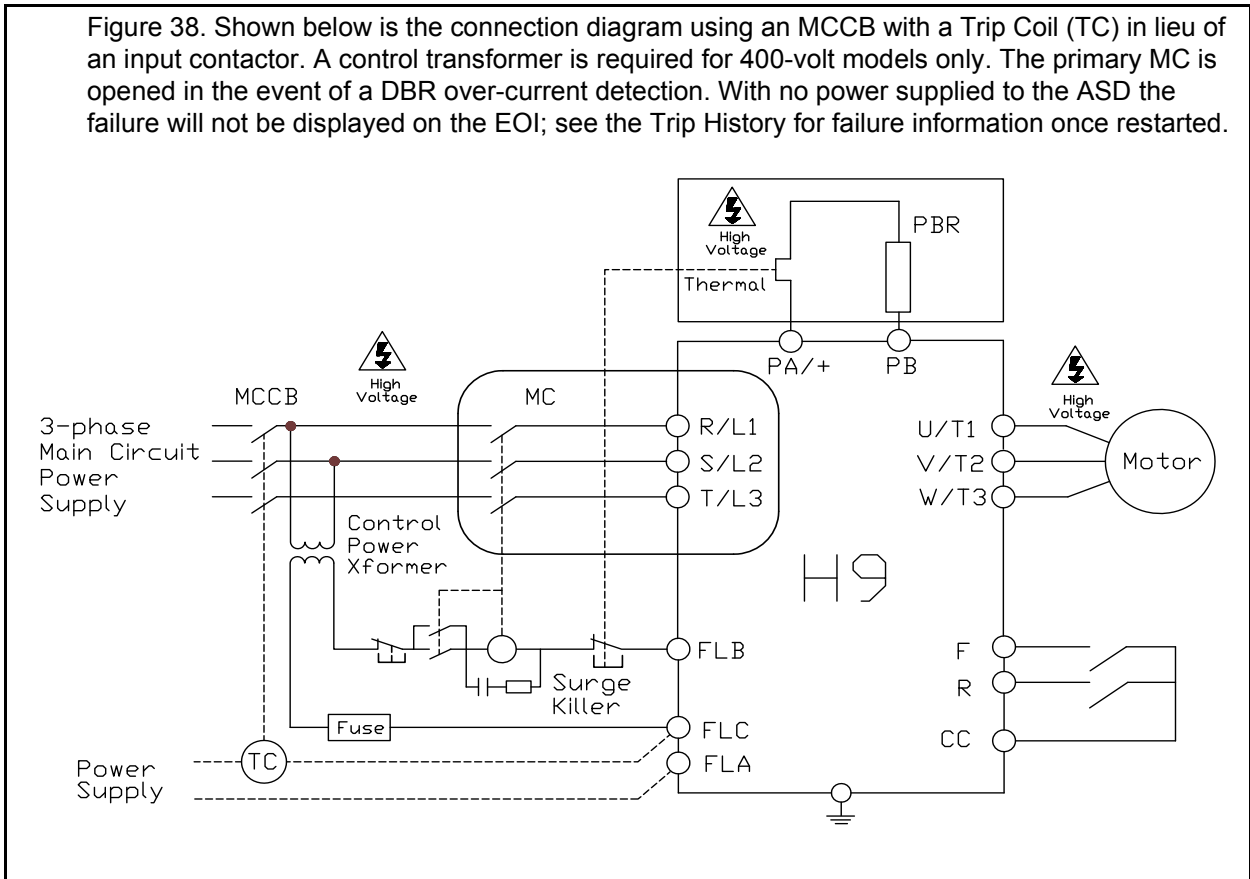

Figure 38. Shown below is the connection diagram using an MCCB with a Trip Coil (TC) in lieu of an input contactor. A control transformer is required for 400-volt models only. The primary MC is opened in the event of a DBR over-current detection. With no power supplied to the ASD the failure will not be displayed on the EOI; see the Trip History for failure information once restarted.



Short Circuit Protection Recommendations

Table 22. 230/240 and 400/480-Volt ASD Recommended Circuit Breaker Selection.

Model Number VT130H9U	HP	Continuous Output Current (Amps)	Circuit Breaker Part Number
2010	0.75	3.2	HLL36015
2015	1.0	4.2	
2025	2.0	6.8	
2035	3.0	9.6	HLL36025
2055	5.0	15.2	
2080	7.5	22.0	HLL36040
2110	10	28.0	HLL36050
2160	15	42.0	HLL36070
2220	20	54.0	HLL36090
2270	25	68.0	HLL36100
2330	30	80.0	
2400	40	104	HLL36125
2500	50	130	HLL36150
2600	60	154	JLL36200
2750	75	192	
210K	100	248	JLL36250
212K	125	312	LIL36300
4015	1.0	2.1	HLL36015
4025	2.0	3.4	
4035	3.0	4.8	
4055	5	7.6	HLL36025
4080	7.5	11.0	
4110	10	14.0	HLL36040
4160	15	21.0	HLL36070
4220	20	27.0	
4270	25	34.0	HLL36090
4330	30	40.0	HLL36100
4400	40	52.0	HLL36125
4500	50	65.0	HLL36150
4600	60	77.0	JLL36200
4750	75	96.0	JLL36225
410K	100	124	JLL36250
412K	125	156	LIL36300
415K	150	180	
420K	200	240	LIL36400
425K	250	302	
430K	300	361	LIL36450
435K	350	414	LIL36500
440K	400	477	Consult NEC

H9 ASD Optional Devices

The ASD may be equipped with several options which are used to expand the functionality. [Table 23](#) lists the available options and their functions.

Table 23. H9 Optional Devices and Functions.

Part Identifier	Device Name	Device Function
ASD-CAB-USB	H9 USB Communication Cable	Used to connect the ASD to a PC via the USB port of the PC.
ASD-EOI-HH-G9	Display Module Docking Station	Used to flash the 9-series display module.
ASD-MTG-KIT9	9-Series EOI Remote Mounting Kit	Hardware used to mount 9-series ASD EOI remotely.
ASD-TB1-SIM9	ASD Input/Output Signal Simulator	Used to simulate the ASD I/O monitor and control signals.
DEV002Z	DeviceNet Module	Allows the ASD to communicate via DeviceNet with other DeviceNet-supported equipment including a host computer.
ETB003Z	Expansion I/O Board 1	Expands the Input/Output functionality of the ASD.
ETB004Z	Expansion I/O Board 2	Expands the Input/Output functionality of the ASD.
PDP002Z	ProfiBus DP Module	Allows the ASD to communicate via ProfiBus with other ProfiBus-supported equipment including a host computer.
USB001Z	USB-to-Serial Converter	Allows for the USB port of a computer to be used as a communications port for monitoring and controlling the ASD.
VEC007Z	PG Vector Feedback Board	Allows for the use of Vector Control using a sensor (for use with a 5-volt encoder).
VEC004Z	PG Vector Feedback Board	Allows for the use of Vector Control using a sensor (for use with a 12-volt encoder).
VEC005Z	PG Vector Feedback Board	Allows for the use of Vector Control using a sensor (for use with a 15-volt encoder).
VEC006Z	PG Vector Feedback Board	Allows for the use of Vector Control using a sensor (for use with a 24-volt encoder).
Note: See the user manual of the applicable option for further information on each item.		

Index

Numerics

0 Hz Command Output, 125
0 Hz Dead Band Signal, 124
16-Bit Binary/BCD Input, 87

A

Abnormal Speed Detection Time, 187
Abnormal Speed Settings, 52
Acc/Dec 1 – 4 Settings, 56
Acc/Dec Pattern 1, 165
Acc/Dec Pattern 1 – 4, 167
Acc/Dec Pattern 2, 166
Acc/Dec Special, 56
Accel/Decel 1 Settings, 46
Accel/Decel Operation After Torque Limit, 159
Accel/Decel Suspend, 144
Accel/Decel Switching Frequency 1, 167
Acceleration, 80
Acceleration Suspend Frequency, 145
Acceleration Suspend Time, 145
Acceleration Time 1, 80
Acceleration Time 2, 164
Acceleration Time 3, 168
Acceleration Time 4, 169
Acceleration/Deceleration Pattern 3, 169
Acceleration/Deceleration Pattern 4, 170
Acceleration/Deceleration Switching Frequency 2, 169
Acceleration/Deceleration Switching Frequency 3, 170
activate the battery backup, 28
Adding Input Selection, 191
AI2, 88
AI2 (Option V/I) Input Bias, 163
AI2 (Option V/I) Input Gain, 163
Alarm Prohibition, 50
Alarms, 244, 246
Always ON 1 Terminal 1, 88
AM, 21, 23
AM Bias Adjustment, 195
AM Output, 43
AM Output Gradient Characteristic, 194
AM Output Terminal Adjustment, 192
AM Output Terminal Function, 192
AM/FM Output, 25
Analog Filter, 54
Analog Function Assigned Object 11, 226

Analog Function Assigned Object 21, 227
Analog Input Filter, 109
Analog Input Function Target 11, 226
Analog Input Function Target 21, 226
Analog Output Terminals, 47
Annual Average Ambient Temperature, 189
ASD Capacity, 13
ASD Input Phase Failure Detection, 184
ASD Load, 43
ASD Number, 202
ASD OL (Overload) Trip, 43
ASD Operation at Disconnect, 210
ASD Output Phase Failure Detection, 183
ASD Overload, 43, 188, 252
ASD Side-Switching Wait Time, 147
ASD-to-ASD Communications (2-Wire), 204
ASD-to-ASD Communications (2-wire), 207
Atn, 245
At-Trip Recorded Parameters, 253
Auto Accel/Decel, 71
Auto Restart, 133
Automatic Acceleration/Deceleration, 76
Automatic Function Selection, 85
Automatic Light-Load High-Speed
 Operation Frequency, 141
Automatic Torque Boost, 76
Autotune Error, 250
Autotuning, 10
Autotuning 1, 151
Autotuning 2, 152

B

Base Frequency 1, 81
Base Frequency 2, 98
Base Frequency 3, 99
Base Frequency 4, 100
Base Frequency Voltage, 52
Base Frequency Voltage 1, 152
Base Frequency Voltage 2, 98
Base Frequency Voltage 3, 99
Base Frequency Voltage 4, 100
Battery Backup, 28
battery life, 28
Baud Rate (2-Wire RS485), 202
Baud Rate (4-Wire RS485), 206
Bezel Plate Mounting Hardware, 33

- BIN Input Point 1 Frequency, 121
- BIN Input Point 1 Setting, 120
- BIN Input Point 2 Frequency, 121
- BIN Input Point 2 Setting, 121
- Block Read Data 1, 212
- Block Read Data 2, 212
- Block Read Data 3, 212
- Block Read Data 4, 213
- Block Read Data 5, 213
- Block Write Data 1, 211
- Block Write Data 2, 211
- Brake Answer Wait Time, 188
- Braking Mode Selection, 142
- Braking Resistance Overload Time (10x Rated Torque), 190
- Braking Time Learning Function, 144

C

- Cable/Terminal Specifications, 264
- Carrier Frequency, 56
- Carrier Frequency Control Mode, 138
- CC, 22
- CCA, 22
- Change Step Selection 1, 197
- Change Step Selection 2, 198
- Changed From Default, 51, 74
- Changed From Default Screen, 74
- Charge LED, 9, 16
- Circuit Breaker Configuration, 15
- Clearing a Trip, 253
- Clock Setup, 50
- CM1, 246
- CM2, 246
- CMOD/FMOD Change Lockout, 200
- Command Control Selections, 39
- Command Mode, 77
- Command Mode and Frequency Mode Control, 36
- Command Source, 72
- Commercial Power Switching Freq. Hold Time, 147
- Commercial Power Switching Wait Time, 147
- Commercial Power/ASD Output Switching, 146
- Commercial Power/ASD Switching Frequency, 147
- Communication Adjustments, 64
- Communication Error, 249
- Communication Settings, 64
- Communications, 64
- Communications Option (DeviceNet/Profibus) Setting 1, 207
- Communications Option (DeviceNet/Profibus) Setting 2, 208
- Communications Option (DeviceNet/Profibus) Setting 8, 209

- Communications Option Speed Switch Monitor DeviceNet/CC-Link, 211
- Communications Option Station Address Monitor, 210
- Communications Setting Changes, 74
- Communications Time Out Time (2- and 4-Wire RS485), 202
- Communications Time-Out Action (2- and 4-wire RS485), 203
- Compensation Frequency, 43
- Conduit Plate Dimensions, 254
- Connect IICC to CCA, 105
- Connecting the ASD, 16
- Connection Diagram, 26
- Continuous Dynamic Braking Capacity, 137
- Contrast, 51
- Control Power Under-Voltage, 252
- Cooling Fan Control, 186
- CPU Fault, 249
- Crane/Hoist Settings, 56
- Creeping Frequency, 143
- Creeping Time, 144
- Cumulative Operation Time Alarm, 186
- Current Control Proportional Gain, 160
- Current/Voltage, 262
- Current/Voltage Specifications, 262
- Customer Support, 2

D

- dbOn, 245
- DBR Load, 43
- DBR OL (Overload) Trip, 43
- DBR Over-Current, 267
- DBR Overload, 43
- DC Bus Voltage, 43
- DC Injection Braking, 52
- DC Injection Braking Current, 124
- DC Injection Braking Start Frequency, 124
- DC Injection Braking Time, 125
- Deceleration Suspend Frequency, 145
- Deceleration Suspend Time, 145
- Deceleration Time 1, 80
- Deceleration Time 2, 164
- Deceleration Time 3, 169
- Deceleration Time 4, 170
- Default Setting Changes, 74
- Direct Access, 49
- Disconnection Detection Extended Time, 210
- Discrete Input, 21, 25
- Discrete Input Terminals, 45
- Discrete Output, 21
- Display Bias, 197
- Display Gradient Characteristic, 197

- Display Parameters, 49
- Display Unit Multiplication Factor, 196
- Display Unit Selection, 197
- Display Units for Voltage and Current, 196
- Disposal, 3
- Drooping, 139
- Drooping Control, 60
- Drooping Gain, 139
- Drooping Insensitive Torque, 140
- Drooping Output Filter, 140
- Dynamic Braking, 52, 136
- Dynamic Braking Resistance, 137
- Dynamic Braking Resistor Over-Current, 251
- Dynamic Braking Resistor Overload, 252
- Dynamic Braking System Specifications, 266

E

- E, 248
- E-10, 248
- E-11, 248
- E-12, 248
- E-13, 248
- E-17, 248
- E-18, 248
- E-19, 248
- E-20, 248
- E-21, 248
- E-22, 248
- E-23, 248
- E-24, 248
- E-25, 249
- E-26, 249
- EEP1, 249
- EEP2, 249
- EEP3, 249
- EEPROM Data Fault, 249
- EEPROM Fault, 249
- EF1, 249
- EF2, 249
- Electronic Operator Interface, 28
- Electronic Operator Interface Features, 30
- Emergency Off, 31, 248
- Emergency Off DC Injection Application Time, 183
- Emergency Off Mode Settings, 183
- Emergency Off Settings, 52
- EMG, 246
- Enclosure Dimensions, 254
- Encoder Loss, 248
- End Frequency, 124
- EOI ASD-MTG-KIT9 Mounting Dimensions, 35
- EOI Command Screen, 42
- EOI Installation Precautions, 34

- EOI Mounting Dimensions, 34
- EOI Operation, 28
- EOI Operation Jog Mode, 127
- EOI Remote Mounting, 29
- EOI Remote Mounting Using the ASD-MTG-KIT9, 35
- EOI Remote Mounting w/o the ASD-MTG-KIT9, 34
- EPHI, 249
- EPHO, 249
- Equipment Inspection, 3
- ERR2, 249
- ERR3, 249
- ERR4, 249
- ERR5, 249
- ERR6, 249
- ERR7, 249
- ERR8, 249
- ERR9, 249
- ESC Key, 30
- ETN, 250
- ETN1, 250
- ETN2, 250
- ETN3, 250
- ETYP, 250
- Excitation Current, 44
- Exciting Strengthening Coefficient, 153
- Extender Cables, 33
- External Overheat, 251

F

- F, 21, 22
- Fan Control, 186
- Fault, 244
- Fault Relay, 25
- Faults, 244
- Feedback, 60
- Feedback (1 second), 44
- Feedback (inst), 44
- Feedback Settings, 60
- FLA, 21, 23
- FLA, B, and C Switching Relationship, 24
- Flash Memory Fault, 249
- FLB, 21, 23
- FLC, 21, 23, 24
- FM, 21, 23
- FM Bias Adjustment, 194
- FM Output, 43
- FM Output Gradient Characteristic, 194
- FM Output Terminal Adjustment, 78
- FM Output Terminal Function, 78
- FM Voltage/Current Output Switching, 194
- FMOD, 104
- Forward Run/Reverse Run Disable, 138

- Forward Speed Limit Input, 155
- Forward Speed Limit Level, 155
- Forward/Reverse DC Injection Braking Priority, 125
- Forward/Reverse Disable, 54
- Forward/Reverse Run Priority Selection, 86
- Forward/Reverse Run Selection, 79
- FP, 21, 23
- FP Output, 25
- FP Terminal Assignment, 193
- Free Notes, 213
- Frequency, 54
- Frequency at Trip, 43
- Frequency Command Mode, 41
- Frequency Command Screen, 32, 73
- Frequency Control, 57
- Frequency Control Selections, 39
- Frequency Mode 1, 77
- Frequency Mode 2, 108
- Frequency Mode Control, 36
- Frequency Mode Priority Switching Frequency, 108
- Frequency Point Selection, 204
- Frequency Priority Selection, 104
- Frequency Reference, 43
- Frequency Reference Source, 73
- Frequency Setting, 41
- Frequency Settings, 46
- Fundamental, 46

G

- Gate Array Fault, 249
- General Safety Information, 1
- Ground Fault, 249

H

- Handling and Storage, 3
- Heavy-Load Torque During Constant Power Running, 142
- Heavy-Load Torque During Power Running, 142

I

- I/O and Control, 21
- I/O Circuit Configurations, 25
- IICC, 22, 26, 105, 107
- Important Notice, 3
- Initial Setup, 70
- Initial UP/DOWN Frequency, 129
- Initial UP/DOWN Frequency Rewriting, 129
- Input Function Command 1, 213, 215, 216, 221, 222, 223, 224

- Input Function Command 2, 214, 215, 216, 221, 222, 223, 225
- Input Function Target 1, 213, 215, 216, 220, 222, 223, 224
- Input Function Target 2, 214, 215, 216, 221, 222, 223, 225
- Input Function Target 3, 214, 215, 217, 221, 222, 224, 225
- Input Phase Failure, 249
- Input Phase Failure Detection, 184
- Input Power, 44
- Input Special Functions, 47
- Input Terminal 1 (F) Function, 88
- Input Terminal 1 (F) Response Time, 95
- Input Terminal 10 (LI2) Function, 90
- Input Terminal 11 (LI3) Function, 90
- Input Terminal 12 (LI4) Function, 91
- Input Terminal 13 – 20 Response Time, 96
- Input Terminal 13 (LI5) Function, 91
- Input Terminal 14 (LI6) Function, 91
- Input Terminal 15 (LI7) Function, 92
- Input Terminal 16 (LI8) Function, 92
- Input Terminal 17 (B12) Function, 96
- Input Terminal 18 (B13) Function, 96
- Input Terminal 19 (B14) Function, 97
- Input Terminal 2 (R) Function, 88
- Input Terminal 2 (R) Response Time, 95
- Input Terminal 20 (B15) Function, 97
- Input Terminal 3 (ST) Function, 88
- Input Terminal 3 (ST) Response Time, 95
- Input Terminal 4 (RES) Function, 89
- Input Terminal 4 (RES) Response Time, 96
- Input Terminal 5 – 12 Response Time, 96
- Input Terminal 5 (S1) Function, 89
- Input Terminal 6 (S2) Function, 89
- Input Terminal 7 (S3) Function, 89
- Input Terminal 8 (S4) Function, 89
- Input Terminal 9 (LI1) Function, 90
- Input Terminal Delays, 47
- Input Terminal Priority, 87
- Input Terminals, 48
- Installation and Connections, 14
- Installation Notes, 14
- Installation Precautions, 4
- isolated V/I input, 105

J

- Jog Frequency, 126
- Jog Settings, 54
- Jog Stop Pattern, 127
- Jump Frequencies, 57
- Jump Frequency 1, 130

- Jump Frequency 1 Bandwidth, 131
- Jump Frequency 2, 131
- Jump Frequency 2 Bandwidth, 131
- Jump Frequency 3, 131
- Jump Frequency 3 Bandwidth, 131

L

- LCD Character/Font Information, 31
- LCD Screen, 30, 32
- Lead Length Specifications, 20
- LED Character/Font Information, 31
- LED Screen, 30, 31
- LED/LCD Screen Information, 31
- Light Load Conditions, 11
- Light-Load High-Speed Learning Function, 140
- Light-Load High-Speed Operation, 140
- Light-Load High-Speed Operation Detection Time, 141
- Light-Load High-Speed Operation Heavy-Load Detection Time, 141
- Light-Load High-Speed Operation Load Wait Time, 141
- Light-Load High-Speed Operation Switching Lower-Limit Frequency, 141
- Line Power Switching, 48
- Linear Acceleration, 165
- Load Moment of Inertia 1, 160
- Load Moment of Inertia 2, 161
- Load Sharing Gain Input, 155
- Load-Produced Negative Torque, 12
- Local Mode, 30
- Local/Remote Key, 30
- Lockout, 69
- Lockout All Keys, 200
- Low Speed Operation, 10
- Low-Current, 249
- Low-Current Detection Current Hysteresis Width, 184
- Low-Current Detection Threshold, 185
- Low-Current Settings, 52
- Low-Current Trip, 184
- Low-Current Trip Threshold Time, 185
- Lower Limit Frequency, 81
- Lower-Limit Frequency, 71
- Low-Speed Signal Output Frequency, 86
- Lug Size, 264, 265

M

- Main Monitor Selections, 45
- Manual Torque Boost 1, 82
- Manual Torque Boost 2, 98
- Manual Torque Boost 3, 99
- Manual Torque Boost 4, 100

- Manual Torque Limit Settings, 59
- Maximum Frequency, 80
- MCP Rating, 264, 265
- Mode Key, 30
- MOFF, 246
- MON 1 Bias Adjustment, 195
- MON 1 Output Gradient Characteristic, 195
- MON 1 Voltage/Current Output Switching, 195
- MON 2 Bias Adjustment, 196
- MON 2 Output Gradient Characteristic, 196
- MON 2 Voltage/Current Output Switching, 195
- MON1 Terminal Adjustment, 193
- MON1 Terminal Meter Selection, 192
- MON2 Terminal Adjustment, 193
- MON2 Terminal Meter Selection, 193
- Monitor Mode, 43
- Monitor Output Function 11, 227
- Monitor Output Function 21, 228
- Monitor Output Function 31, 228
- Monitor Output Function 41, 229
- Monitor Output Function Command 11, 227
- Monitor Output Function Command 21, 228
- Monitor Output Function Command 31, 229
- Monitor Output Function Command 41, 229
- Monitor Screen, 32
- Motor 150% Overload Time Limit, 184
- Motor Braking, 12
- Motor Characteristics, 10
- Motor Connection Diagram, 17
- Motor Constant 1, 153
- Motor Constant 2, 153
- Motor Constant 3, 153
- Motor Constant 4, 153
- Motor Current Rating, 72
- Motor Load, 43
- Motor OL (Overload) Trip, 43
- Motor Overload, 252
- Motor Overload Protection Configuration, 82
- Motor Overload Protection Level 1, 182
- Motor Overload Protection Level 2, 98
- Motor Overload Protection Level 3, 99
- Motor Overload Protection Level 4, 100
- Motor Overload Real, 43
- Motor Rated Capacity, 152
- Motor Rated Current, 152
- Motor Rated RPM, 152
- Motor Set 1, 46
- Motor Set 2, 58
- Motor Set 3, 58
- Motor Set 4, 58
- Motor Shaft Fixing Control, 125
- Motor/Load Combinations, 11
- Mounting the ASD, 15
- Multiplying Input Selection, 191

- My Function Count Data 1, 220
- My Function Count Data 2, 220
- My Function Frequency Data 1, 218
- My Function Frequency Data 2, 218
- My Function Frequency Data 4, 219
- My Function Frequency Data 5, 219
- My Function Percent Data 1, 217
- My Function Percent Data 3, 218
- My Function Percent Data 4, 218
- My Function Percent Data 5, 218
- My Function Selection, 231
- My Function Time Data 1, 219
- My Function Time Data 2, 219
- My Function Time Data 3, 219
- My Function Time Data 4, 220
- My Function Time Data 5, 220

N

- NERR, 250
- Network Option Reset Settings, 213
- Number of PG Input Phases, 150
- Number of PG Input Pulses, 150

O

- O1A/B, 21
- O2A/B, 23
- OC, 246
- OC1, 250
- OC1P, 250
- OC2, 251
- OC2P, 251
- OC3, 251
- OC3P, 251
- OCA1, 251
- OCA2, 251
- OCA3, 251
- OCL, 251
- OCR, 251
- OH, 246, 251
- OH2, 251
- OJ, 246
- OL1, 252
- OL2, 252
- OLI, 247
- OLM, 247
- OLR, 247, 252
- OP, 247
- OP1, 252
- OP2, 252
- OP3, 252

- Operation (Local), 73
- Operation Above 60 Hz, 10
- Operation Command Clear Selection When ST Off, 198
- Operation Mode, 65
- Operation Panel Parameters, 58
- Operational and Maintenance Precautions, 9
- Option V/I Terminal Voltage/Current Selection, 88
- Optional Devices, 269
- Options, 269
- OT, 247, 252
- OUT1, 21, 23
- Out1 Out2 FL, 45
- OUT1/OUT2 Output, 25
- OUT2, 23
- Output Current, 43
- Output Disconnect, 8
- Output Function Assigned, 214, 216, 217, 221, 223, 224, 225
- Output Phase Failure, 249
- Output Phase Failure Detection, 183
- Output Power, 44
- Output Terminal 1 (OUT1) Function, 92
- Output Terminal 10 (R3) Function, 97
- Output Terminal 11 (R4) Function, 97
- Output Terminal 2 (OUT2) Function, 92
- Output Terminal 3 (FL) Function, 93
- Output Terminal 4 (OUT3) Function, 93
- Output Terminal 5 (OUT4) Function, 93
- Output Terminal 6 (R1) Function, 94
- Output Terminal 7 (OUT5) Function, 94
- Output Terminal 8 (OUT6) Function, 94
- Output Terminal 9 (R2) Function, 95
- Output Terminals, 49
- Output Voltage, 43
- Over-Current During Acceleration, 250
- Over-Current During Deceleration, 251
- Over-Current During Run, 251
- Over-Current Protection, 13
- Overheat, 251
- Overheat During Acceleration, 250
- Overheat During Deceleration, 251
- Overheat During Run, 251
- Overload, 52, 53
- Overload Protection, 10
- Overload Reduction Starting Frequency, 184
- Override Control, 61
- Override Mode, 38
- Override Operation, 38
- Over-Speed, 248
- Over-Speed Detection Frequency Lower Band, 187
- Over-Speed Detection Frequency Upper Band, 187
- Over-Torque, 252
- Over-Torque Detection Hysteresis, 186
- Over-Torque Detection Level (Negative Torque), 186

Over-Torque Detection Level (Positive Torque), 186
Over-Torque Detection Time, 186
Over-Torque Parameters, 53
Over-Torque Trip, 185
Over-Voltage During Acceleration, 252
Over-Voltage During Deceleration, 252
Over-Voltage Limit Operation, 136
Over-Voltage Limit Operation Level, 187

P

P24, 21, 23
P24 Output, 25
PA/+, 16
Panel Emergency Off Lockout, 199
Panel Frequency Lockout, 199
Panel Load Sharing Gain, 199
Panel Override Multiplication Gain, 199
Panel Reset Lockout, 200
Panel Stop Pattern, 198
Panel Tension Torque Bias, 199
Panel Torque Bias, 143
Panel Torque Command, 199
Panel Torque Gain, 143
Parameter Write Lockout, 196
Parity (2- and 4-Wire RS485), 202
Part Numbering Convention, 254
Password, 69
Past Trip 1, 44
Past Trip 2, 44
Past Trip 3, 44
Past Trip 4, 45
Pattern 1 Repeat, 171
Pattern 2 Repeat, 174
Pattern Group 1 Selection 1, 172
Pattern Group 1 Selection 2, 173
Pattern Group 1 Selection 3, 173
Pattern Group 1 Selection 4, 173
Pattern Group 1 Selection 5, 173
Pattern Group 1 Selection 6, 174
Pattern Group 1 Selection 7, 174
Pattern Group 1 Selection 8, 174
Pattern Group 2 Selection 1, 175
Pattern Group 2 Selection 2, 175
Pattern Group 2 Selection 3, 175
Pattern Group 2 Selection 4, 175
Pattern Group 2 Selection 5, 176
Pattern Group 2 Selection 6, 176
Pattern Group 2 Selection 7, 176
Pattern Group 2 Selection 8, 176
Pattern Group Cycle, 44
Pattern Group Number, 44
Pattern Group Preset, 44
Pattern Operation Mode, 170
Pattern Run, 65
Pattern Time, 44
PC/-, 16
Permanent Magnet (PM) Motor Constant 1, 164
Permanent Magnet (PM) Motor Constant 2, 164
PG Disconnection Detection, 151
PG Input Point 1 Frequency, 122
PG Input Point 1 Setting, 122
PG Input Point 2 Frequency, 123
PG Input Point 2 Setting, 123
PG Settings, 61
PG Type/Connection Error, 248
Phase Loss, 53
PID Control Switching, 147
PID Control Wait Time, 149
PID Deviation Lower-Limit, 149
PID Deviation Upper-Limit, 148
PID Feedback, 44
PID Feedback Delay Filter, 148
PID Feedback Differential (D) Gain, 149
PID Feedback Integral (I) Gain, 148
PID Feedback Proportional (P) Gain, 148
PID Feedback Signal, 148
PID Output Lower-Limit, 150
PID Output Upper-Limit, 149
PM Motor, 164
PO, 16
POFF, 247
Point 1 Frequency, 205
Point 1 Setting, 205
Point 2 Frequency, 206
Point 2 Setting, 205
Power Connections, 16
Power Factor Correction, 11
Power Running, 142
Power Running Stall Continuous Trip Detection Time, 159
Power Running Torque Limit 1, 157
Power Running Torque Limit 1 Level, 157
Power Running Torque Limit 2 Level, 158
Power Running Torque Limit 3 Level, 158
Power Running Torque Limit 4 Level, 159
PP, 21, 23
PP Output, 25
Preset Speed 1, 83
Preset Speed 1 Operation Mode, 180
Preset Speed 10, 132
Preset Speed 10 Operation Mode, 181
Preset Speed 11, 132
Preset Speed 11 Operation Mode, 181
Preset Speed 12, 132
Preset Speed 12 Operation Mode, 181
Preset Speed 13, 132

- Preset Speed 13 Operation Mode, 181
- Preset Speed 14, 132
- Preset Speed 14 Operation Mode, 182
- Preset Speed 15, 133
- Preset Speed 15 Operation Mode, 182
- Preset Speed 2, 83
- Preset Speed 2 Operation Mode, 180
- Preset Speed 3, 84
- Preset Speed 3 Operation Mode, 180
- Preset Speed 4, 84
- Preset Speed 4 Operation Mode, 181
- Preset Speed 5, 84
- Preset Speed 5 Operation Mode, 181
- Preset Speed 6, 84
- Preset Speed 6 Operation Mode, 181
- Preset Speed 7, 84
- Preset Speed 7 Operation Mode, 181
- Preset Speed 8, 131
- Preset Speed 8 Operation Mode, 181
- Preset Speed 9, 132
- Preset Speed 9 Operation Mode, 181
- Preset Speed Operation Mode, 179
- Preset Speed Operation Selection, 210
- Preset Speeds, 54
- Primary Menus, 32
- Process Decreasing Rate, 150
- Process Increasing Rate, 150
- Process Lower-Limit, 149
- Process Upper-Limit, 149
- Program Menu, 32
- Program Mode Menu Navigation, 46
- Prohibition, 49
- Protection, 52
- PTC1 Thermal Selection, 189
- PTC2 Thermal Selection, 190
- PtSt, 247
- Pulse Output Frequency, 194
- Pulse Width Modulation, 10
- PWM Carrier Frequency, 133

Q

- Qualified Personnel, 2

R

- R, 21, 22
- R/L1, 16
- RAM Fault, 249
- Random Mode, 138
- Reach Settings, 49
- Read Error, 249

- Real-Time Clock Setup, 50
- Regenerative Braking Torque Limit 1, 158
- Regenerative Braking Torque Limit 1 Level, 158
- Regenerative Braking Torque Limit 2 Level, 158
- Regenerative Braking Torque Limit 3 Level, 159
- Regenerative Braking Torque Limit 4 Level, 159
- Regenerative Power Ridethrough Control Level, 188
- Regenerative Power Ridethrough Mode, 134
- Release Time, 143
- Remote EOI Hardware, 33
- Remote Mode, 30
- RES, 21, 22
- Reset, 50, 79
- Restore User Settings, 75
- Retain Trip Record at Power Down, 182
- Retry Selection, 135
- Retry/Restart, 53
- Reverse Speed Limit Input, 156
- Reverse Speed Limit Input Level, 156
- Ridethrough Time, 137
- ROM Fault, 249
- Root Menu Mapping, 41
- Root Menus, 41
- Rotary Encoder, 30
- Rotation in Specified Direction ONLY, 157
- RR, 21, 22, 44
- RR Input, 25
- RR Input Bias, 162
- RR Input Gain, 162
- RR Input Point 1 Frequency, 110
- RR Input Point 1 Rate, 112
- RR Input Point 1 Setting, 110
- RR Input Point 2 Frequency, 111
- RR Input Point 2 Rate, 112
- RR Input Point 2 Setting, 111
- RS485 4-Wire Protocol Selection (TSB/ModBus), 207
- RS485 Protocol Selection, 204
- RS485 Send Wait Time (RS485 4-Wire), 206
- Run Frequency, 123
- Run Frequency Hysteresis, 124
- Run Key, 30
- Run Time, 43
- Rush Relay Current Activation Time, 189
- RX, 21, 23, 44
- RX Input, 25
- RX Input Bias, 162
- RX Input Gain, 162
- RX Input Point 1 Frequency, 113
- RX Input Point 1 Rate, 115
- RX Input Point 1 Setting, 113
- RX Input Point 2 Frequency, 114
- RX Input Point 2 Rate, 115
- RX Input Point 2 Setting, 114
- RX2, 44

- RX2 (AI1) Input Bias, 163
- RX2 (AI1) Input Gain, 163
- RX2 (AI1) Input Point 1 Frequency, 117
- RX2 (AI1) Input Point 1 Rate, 118
- RX2 (AI1) Input Point 1 Setting, 116
- RX2 (AI1) Input Point 2 Frequency, 117
- RX2 (AI1) Input Point 2 Rate, 119
- RX2 (AI1) Input Point 2 Setting, 117

S

- S/L2, 16
- S1, 21, 22
- S2, 21, 22
- S3, 21, 22
- S4, 21, 22
- Save User Settings, 75
- Second Speed Loop Proportional Gain, 160
- Second Speed Loop Stabilization Coefficient, 161
- Send Wait Time (2-wire), 203
- Setpoints, 59
- Short Circuit Detection At Start, 185
- Short Circuit Protection, 268
- Simple Positioning Completion Range, 151
- Sink, 24
- Sink/Source Setting Error, 248, 249
- Slip Frequency Gain, 151
- Source, 24
- SOUT, 252
- S-Pattern 1, 165
- S-Pattern 2, 165
- S-Pattern Acceleration Lower-Limit Adjustment, 168
- S-Pattern Acceleration Upper-Limit Adjustment, 168
- S-Pattern Deceleration Lower-Limit Adjustment, 168
- S-Pattern Deceleration Upper-Limit Adjustment, 168
- Special, 56
- Special Parameters, 57
- Special Protection Parameters, 53
- Speed 1 Operation Time, 177
- Speed 10 Operation Time, 178
- Speed 11 Operation Time, 178
- Speed 12 Operation Time, 178
- Speed 13 Operation Time, 179
- Speed 14 Operation Time, 179
- Speed 15 Operation Time, 179
- Speed 2 Operation Time, 177
- Speed 3 Operation Time, 177
- Speed 4 Operation Time, 177
- Speed 5 Operation Time, 177
- Speed 6 Operation Time, 177
- Speed 7 Operation Time, 178
- Speed 8 Operation Time, 178
- Speed 9 Operation Time, 178
- Speed at 0% Drooping Gain, 139
- Speed at F320 Drooping Gain, 139
- Speed Error, 248
- Speed Limit (torque=0) Band, 157
- Speed Limit (torque=0) Center Value, 156
- Speed Limit (torque=0) Center Value Reference, 156
- Speed Loop Proportional Gain, 160
- Speed Loop Stabilization Coefficient, 160
- Speed PID Switching Frequency, 161
- Speed Reach Detection Band, 86
- Speed Reach Frequency, 86
- Speed Reference Setpoints, 55, 56
- ST, 21, 22
- Stall, 53
- Stall Prevention During Regeneration, 160
- Stall Prevention Factor 1, 154
- Stall Prevention Level, 182
- Standard Mode Selection, 46
- Start Frequency, 123
- Startup and Test, 27
- Startup Wizard Parameter Requirements, 71
- Stepout Current Detection Level, 190
- Stepout Current Detection Time, 190
- Stop-Reset Key, 31
- SU+, 21, 23
- Supply Voltage Correction, 137
- Switching Load Torque During Power Running, 142
- Switching Load Torque During Regenerative Braking, 142
- Synchronized Acceleration Time, 139
- Synchronized Deceleration Time, 138
- System Configuration and Menu Options, 41
- System Grounding, 18
- System Integration Precautions, 7
- System Operation, 70

T

- T/L3, 16
- Tension Torque Bias Input, 154
- Terminal, 47
- Terminal Board, 21, 24
- Terminal Descriptions, 22
- Time Limit For Lower-Limit Frequency Operation, 125
- Torque, 44, 59
- Torque Bias Input Selection, 143
- Torque Command Selection, 154
- Torque Control, 59, 60
- Torque Current, 44
- Torque Limit Settings, 60
- Torque Reference, 44
- Torque Speed Limiting, 60
- Trace, 49, 50

- Trace Cycle, 201
- Trace Data 1, 201
- Trace Data 2, 201
- Trace Data 3, 201
- Trace Data 4, 201
- Trace Selection, 200
- Traverse, 58
- Traverse Acceleration Time, 233
- Traverse Deceleration Time, 233
- Traverse Jump Step, 233
- Traverse Selection, 233
- Traverse Step, 233
- Trip Code, 44
- Trip History, 253
- Trip History (read-only), 50, 51
- Trip Settings, 53
- Trouble Shooting, 244
- Type Reset, 50, 79
- Typeform Error, 250

U

- U/T1, 16
- UC, 247
- UL 1995, 254
- Under-Voltage Trip, 187
- Under-Voltage Trip Detection Time, 188
- Under-Voltage/Ridethrough, 53
- UP/DOWN Frequency (down) Frequency Step, 129
- UP/DOWN Frequency (down) Response Time, 129
- UP/DOWN Frequency (up) Frequency Step, 129
- UP/DOWN Frequency (up) Response Time, 128
- UP/DOWN Frequency Functions, 54
- Up/Down Frequency Operation, 130
- UP1, 252
- UP2, 252
- U-Phase Over-Current, 251
- Upper Limit Frequency, 81
- Upper-Limit Frequency, 71
- User Notification Codes, 245
- Utilities, 49

V

- V/f 5-Point Setting Frequency 1, 101
- V/f 5-Point Setting Frequency 2, 102
- V/f 5-Point Setting Frequency 3, 103
- V/f 5-Point Setting Frequency 4, 103
- V/f 5-Point Setting Frequency 5, 104
- V/f 5-Point Setting Voltage 1, 102
- V/f 5-Point Setting Voltage 2, 103
- V/f 5-Point Setting Voltage 3, 103
- V/f 5-Point Setting Voltage 4, 103
- V/f 5-Point Setting Voltage 5, 104
- V/f Pattern, 81
- V/I, 44, 54
- V/I Analog Input Broken Wire Detection Level, 189
- V/I Input, 25
- V/I Input Bias, 161
- V/I Input Gain, 161
- V/I Input Point 1 Frequency, 106
- V/I Input Point 1 Rate, 107
- V/I Input Point 1 Setting, 105
- V/I Input Point 2 Frequency, 106
- V/I Input Point 2 Rate, 108
- V/I Input Point 2 Setting, 106
- V/I Settings, 54
- V/T2, 16
- Vector Control, 13
- Vector Motor Model, 59
- Version (read-only), 51
- Viewing Trip Information, 253
- Virtual Input Terminal 1 Selection, 230
- Virtual Input Terminal 2 Selection, 230
- Virtual Input Terminal 3 Selection, 230
- Virtual Input Terminal 4 Selection, 230
- Voltage and Frequency Rating of the Motor, 71
- Volts per Hertz Setting, 72
- V-Phase Over-Current, 251

W

- W/T3, 16
- Warranty Card, 2
- Wizard Finish, 73
- W-Phase Over-Current, 251

TOSHIBA

TOSHIBA INTERNATIONAL CORPORATION
INDUSTRIAL DIVISION

13131 West Little York Road, Houston, TX 77041-5807

US (800) 231-1412 CAN (800) 872-2192 MEX 01 (800) 527-1204

FAX: (713) 466-8773

<http://www.toshiba.com/ind/>

Printed in the U.S.A.